



MARINE
PRODUCTS
SELECTION

NAVICO GROUP

TAKING YOU FURTHER

Navico Group is the world's leading supplier of integrated systems and products to industries ranging from marine to recreational vehicle and beyond. We offer an unmatched portfolio comprised of industry-leading brands in power management, digital control & monitoring, networked devices and marine electronics.

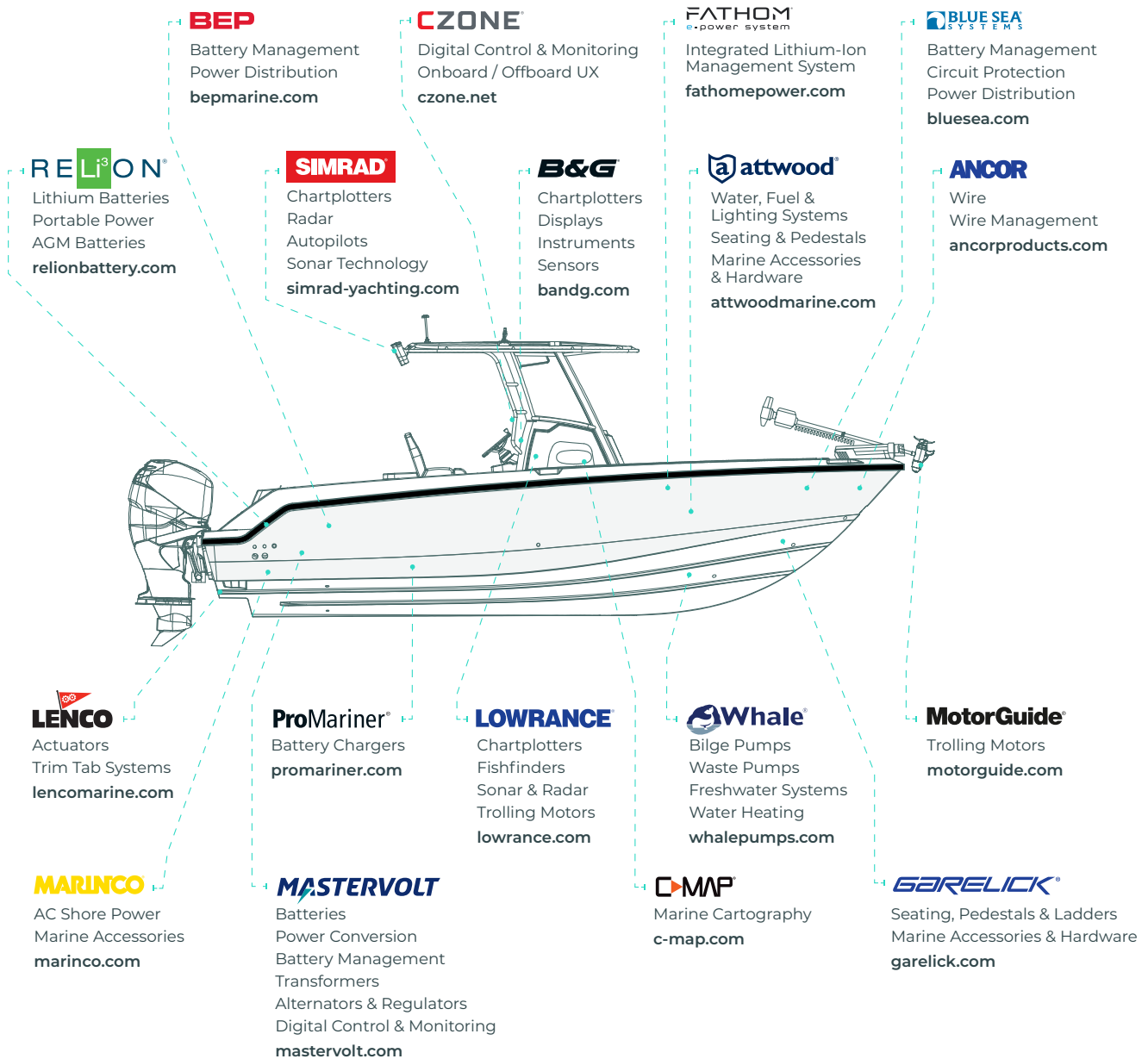

See how far our innovations can take you at Navico.com



What makes Attwood different:

Founder's Vision

Attwood has been a proven marine industry leader for over 100 years. Our wide range of products, including general marine accessories, seat & table hardware, and water systems & ventilation are tested to the highest USCG, ABYC, and CE standards. At Attwood, quality is our highest priority.

Innovation & Engineering

Attwood products are designed and tested to ensure performance and reliability.

Product Focus

Attwood is the leading supplier to OEM's in a majority of our categories, including general marine accessories, fuel systems, lighting, seat & table hardware, and water systems & ventilation.

Global Reach

A global distribution network provides convenient access to products when they are needed.

Industry Standards

Industry involvement ensures products meet industry safety & regulatory standards.

Trusted Quality

Highest quality products and systems you can trust.



NEW Products

attwood® **TSUNAMI** Mk2

18

Tsunami Aerator Mk2 Pump

A breath of fresh air.

Keep your bait and fish alive with the new Tsunami Aerator Mk2. Our leading fish-friendly technology is making it easier to install and service, while offering new installation options never before provided by the Tsunami range.



attwood® **TSUNAMI** Mk2

15

Tsunami Mk2 Manual Bilge Pump

The easiest, most reliable manual bilge pump ever designed.

Attwood is proud to introduce Tsunami Mk2, the ONLY manual bilge pump that eliminates air locks. What makes Tsunami Mk2 so innovative is the patented X-Air™ Impeller. Its engineered performance forces air bubbles trapped in the hose and underside of the pump out of the pipework, so that the pump will not run dry and burn out. This breakthrough technology makes Tsunami Mk2 the most reliable manual bilge pump in freshwater applications.



68

PowerBase Series

The intelligent, automated folding light & antenna.

Attwood is proud to introduce the PowerBase Series, PowerBase easily stows and deploys lights and antennas with the push of a button.



POWER GUARD PRO

139

PowerGuard PRO Battery Box

The only battery box designed with water resistant ventilation to better preserve your battery and protect those onboard.

Built upon the existing strengths of the PowerGuard 27 Series, the new PowerGuard PRO is designed with improvements that offer real value. Developed as a platform for boaters, anglers, and hobbyists alike; the new PowerGuard PRO sets the standard in battery box offerings.



Table of Contents

Water Systems

Bilge Pumps	11
Aerator Pumps	18
Bilge & Float Switches	20
Shower Systems	22
Battery & Hand Operated Pumps	22
Pump Kits & Accessories	23
Plumbing System Fittings	25
Stainless Steel Thru-Hulls & Scupper Valves Fittings	26
Stainless Steel Capped Composite Thru-Hulls	29
Plastic Thru-Hulls & Scupper Valve Fittings	30
Drains, Drain Plugs & Tubes	31

NEW



p. 11

NEW



p. 15

NEW



p. 18



p. 21



p. 22



p. 29



p. 33

Ventilation

Solar Vents	38
Cowl & Clam Shell Vents	40
In-Line Blowers	42
Vents & Collector Boxes	44



p. 38



p. 40



p. 42



p. 44

Lighting

Navigation Overview	50
Deck Mount Sidelights	54
Pole Mounted Plug-In Sidelights	58
All-Round Plug-In Lights	61
All-Round Plug-In Bases	65
PowerBase Series	68
All-Round Fold-Down Lights	70
All-Round Fixed Base Lights	72
Transom Lights	72
Anchor/Masthead Lights	73
Spotlights	74
LED Portable Lighting	77
LED Docking Lights	78
LED Underwater Lights	79
LED Utility Lights	81
Lighting Accessories & Replacements	83



p. 54



p. 58



p. 62



p. 65



p. 68



p. 74



p. 77



p. 80



p. 82

Fuel

Portable Fuel Systems Overview	86
Portable Fuel Tanks	87
Portable Fuel Components	88
Fuel Tanks & Hose Fittings	92
Integrated Fuel Systems Overview	94
Integrated Fuel Components	97
Accessories	103
Portable Fuel Components, International	106
Integrated Fuel Components, International	107



p. 87



p. 88



p. 93



p. 97



p. 101



p. 108

Marine Accessories

Anchoring & Mooring Equipment	112
Marine Ropes & Cordage	118
Fishing Rod Holders & Accessories	125
Marine Maintenance Products	132
Interior & Boating Accessories	133
Electrical Accessories	139
Paddlesports & Accessories	147
Trailer Parts & Accessories	152
Horns	162
Wiper Motors	171
Wiper Arms	178
Wiper Blades	181



Hardware

Cleats	186
Lift Rings	191
Hawse Pipes & Bow Eyes	192
Hooks	193
Water Ski Hardware	194
Bimini Style Convertible Top Accessories	196
Hinges	197
Hatch & Door Hardware	199
Hand Rails & Handles	201
Gas Springs & Accessories	202
Mounting Brackets	204

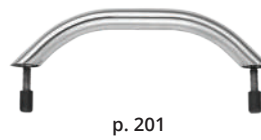

Seating Systems

Seat Types & ABYC Requirements	210
The Factors of Seating Comfort	211
Seating Offerings	212
Fishing Seats	213
Seating Systems	214
Pedestal Systems & Accessories	219



Appendix & Index

Part Number Index	232
-------------------	-----

WATER SYSTEMS

Bilge & Aerator Pumps



11

Attwood pumps are tested and approved as standard equipment by leading boat manufacturers. Bilge and aerator pumps are engineered for high performance, easy installation, and meet U.S. and International certificates and standards.

Sump Pump Boxes



21

Complete shower sump pump systems deliver fast water flow into and out of the sump with easy installation. Meets or exceeds all applicable standards of the ABYC and USCG.

Pump Kits



23

Aerator and bilge pump kits are crafted to provide convenience, even while you are underway.



WATER SYSTEMS

Accessories & Fittings



24

Required accessories and fittings that can be found within our pump kits or sold separately for easy replacement.

Thru-Hull & Scupper Valve Fittings



26

Backed by Attwood's trusted lifetime warranty, our easy to install thru-hulls and scupper valves are built with rugged stainless steel and a solid silicone gasket.

Drain & Drain Plugs



31

Durable hardware that you can rely on to provide bilge drainage when hauling out.

Complete Selection

A complete selection of pumps and blowers are available for fishing boats, runabouts, cruisers, yachts, and commercial boats. Attwood pumps and blowers are tested and approved as standard equipment by leading boat manufacturers.

Bilge and Aerator Pumps

The Heavy-Duty 1700 and 2000 bilge pumps have established Attwood into the commercial market with value-loaded industrial-duty features and performance.

The Tsunami series of cartridge style bilge and aerator pumps are engineered for higher performance in the most service friendly design imaginable. Their cartridge style allows quick and easy replacement without the need to remove hoses or mounting bases.

Automatic Bilge Pumps

All boats over 20' long with sleeping accommodations (excluding fold-out cockpit seats) should use automatic bilge pump systems. Non-automatic pumps drawing 12A or less can easily convert to automatic operation with Attwood Automatic Float Switches (page 20).

Our Sahara Series of automatic pumps range from 500 to 1200 GPH capacities.

Bilge pumps are designed to exhaust standing water only. They are not intended to prevent accumulation of on-board water due to rough weather, hull damage, and/or other unsafe navigational conditions. Note: Bilge and aerator pumps must be lower than the source of water for priming.

Certification, Standards, and Listings - Pumps

All Attwood pumps meet or exceed the following U.S. and international certificates and standards:

- ABYC H-22
- ISO 8846, 8849 Marine
- U.S. Coast Guard Rule, Title 33CFR sections 183.410 and 33CFR 183.425
- NMMA "As Approved Listing"
- CE
- UKCA
- RCA
- All pumps are marine ignition protected

Choice of Electrical Connectors

Attwood pumps feature several wire attachment styles to adapt to your boat's wiring harness. Standard wire on all pumps are tinned and caulked 16-gauge for butt connection. All pumps ignition protected.

Special connectors are available on special order by contacting your Attwood representative.

- Packard Connector
- Packard Connector, Water-Resistant
- Amp Connector
- Amp Connector, Water-Resistant
- Deutsch Connector
- Quick Silver Connector
- Delphi Connector

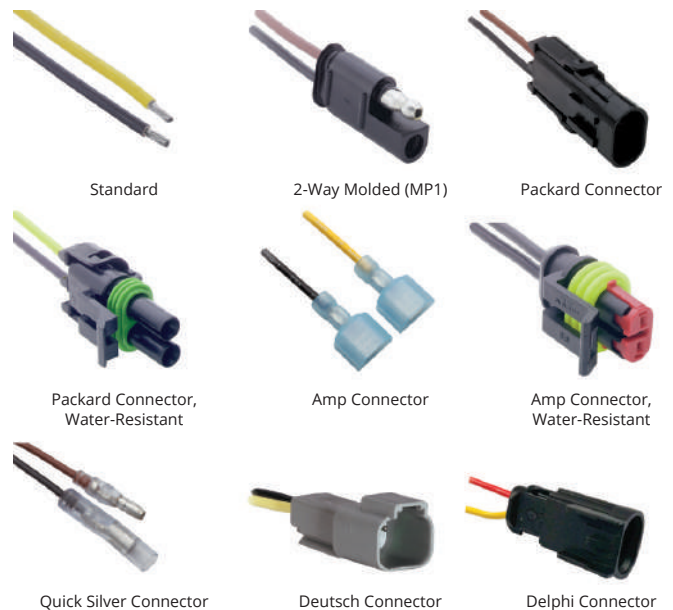

Brown – Positive, Black – Negative, Brown & White – Manual Override

Bilge Pumps



Automatic Bilge Pumps **NEW**

Sahara Mk2 is the only automatic bilge pump that eliminates air-locks

- Patented X-Air™ Impeller ejects trapped air in the pump and pipework.

Sahara Mk2 is the easiest automatic bilge pump to install and service

- External mounting feet and integrated outlet reduces time and effort.
- Universal mounting pattern makes replacement simple.
- Service pump cartridge from hard-to-reach areas using only one hand.

Sahara Mk2 is the most reliable automatic bilge pump in freshwater and saltwater applications

- Attwood's SteadySwitch™ reduces cycling and extends the life of the pump.
- 40% better protection against water ingress and electrolysis - vs. Mk1.
- 2X better protection against water ingress and electrolysis - than the leading competition.



Watch Video
for more info



Flexible Outlets: 90° rotatable elbow outlet allows users to install the pump anywhere in a full 360° orientation.

Exterior Mounting Feet: Eliminates the need to remove the basket, saving OEMs time on production lines.

Single-Hand Pump Cartridge Release: Convenient when trying to access a pump located in a hard-to-reach area of the boat's hull.

Certifications, Standards and Listings

The Sahara Mk2 Automatic Bilge Pumps meet or exceed the following U.S. and international certificates and standards:

Bilge pumps standards

- ABYC H-22
- ISO 8849
- ISO 15083

Ignition protection standards

- ABYC C-1500
- ISO 8846 Marine
- U.S. Coast Guard Rule, 33CFR-183.410

Marine electrical wiring standards

- ABYC E-11
- ISO 10133
- U.S. Coast Guard Rule, 33CFR-183.425

Approvals

- NMMA "As approved listing"
- CE, RCM, UKCA

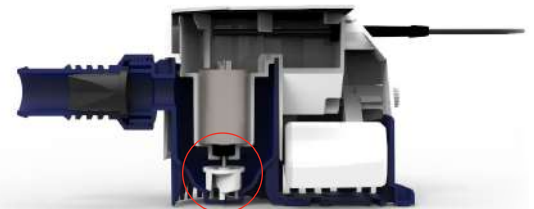

Patented X-Air™ Impeller: Prevents air locking so that the pump will not run dry and burn out.

Model No.	Rated Volts DC	Fuse Size	Outlet Type	Check Valve	OEM Part #	OEM Outlet Straight	OEM Outlet 90°	Part #
S500	12V	3A	3/4" (19mm) & 1" (25mm) Barbs	Yes	—	—	—	5505-7
			3/4" (19mm) Barb	No	5505-2	—	—	—
			1-3/8" Threaded*	Optional	5505-1	AS5505S-1	AS5505E-1	—
S800	12V	4A	3/4" (19mm) & 1" (25mm) Barbs	Yes	—	—	—	5508-7
			3/4" (19mm) Barb	No	5508-2	—	—	—
			1-3/8" Threaded*	Optional	5508-1	AS5505S-1	AS5505E-1	—
S1200	12V	6A	3/4" (19mm) & 1" (25mm) Barbs	Yes	—	—	—	5509-7
			3/4" (19mm) Barb	No	5509-2	—	—	—
			1-3/8" Threaded*	Optional	5509-1	AS5505S-1	AS5505E-1	—
S1200	24V	2A	1" (25mm) & 1-1/8" (28mm) Barbs	Yes	—	—	—	5512-7
			1-1/8" (28mm) Barb	No	5512-2	—	—	—
			1-3/8" Threaded*	Optional	5512-1	AS5512S-1	AS5512E-1	—
S1200	24V	2A	1" (25mm) & 1-1/8" (28mm) Barbs	Yes	—	—	—	5513-7
			1-1/8" (28mm) Barb	No	5513-2	—	—	—
			1-3/8" Threaded*	Optional	5513-1	AS5512S-1	AS5512E-1	—

Wire Length for all models 29-1/2" (750mm). *Must be used with appropriate Sahara outlet.



5505



5509



5512

Service Kits:

- AK5505-7 for S500 and S800
- AK5512-7 for S1200
- Service kits for Barb versions not available

12 Volt Specifications

Model	Automotive Fuse Required (amps)	NRV Fitted	ABYC Specifications 13.6-volts DC (GPH=Gallons Per Hour)			ISO Specifications 12.0-volts DC (LPH=Liters Per Hour)			
			0 ft. Head GPH/amps	3.3 ft. Head GPH/amps	6.7 ft. Head GPH/amps	0m Head LPH/amps	1m Head LPH/amps	2m Head LPH/amps	Max Head (ft@13.6V/m@12V)
T500	3	N	457/1.6	219/1.5	25/1.4	1530/1.6	757/1.3	0	5.6/1.5
	3	Y	432/1.6	191/1.5	33/1.5	1368/1.6	577/1.3	0	5.6/1.5
T800	5	N	825/4.0	460/3.6	287/3.4	2314/3.6	2071/3.6	1002/3.2	10.9/2.6
	5	Y	839/3.9	452/3.5	276/3.4	2274/3.6	1596/3.6	882/3.2	10.9/2.6
T1200	6	N	1146/4.0	654/3.8	419/3.5	4140/3.7	2650/3.6	1633/3.2	11.2/2.7
	6	Y	834/4.0	549/3.6	351/3.5	3000/3.7	2000/3.6	1122/3.0	11.2/2.7

24 Volt Specifications

Model	Automotive Fuse Required (amps)	NRV Fitted	ABYC Specifications 27.2-volts DC (GPH=Gallons Per Hour)			ISO Specifications 24.0-volts DC (LPH=Liters Per Hour)			
			0 ft. Head GPH/amps	3.3 ft. Head GPH/amps	6.7 ft. Head GPH/amps	0m Head LPH/amps	1m Head LPH/amps	2m Head LPH/amps	Max Head (ft@27.2V/m@24V)
T800	2	N	835/1.9	468/1.8	299/1.7	2268/1.8	2071/1.8	982/1.6	11/3.3
	2	Y	832/1.9	465/1.8	283/1.7	2228/1.8	2042/1.8	864/1.6	11/3.3
T1200	3	N	1175/2.0	680/2.0	459/1.8	3912/1.7	2650/1.7	1302/1.5	10.7/2.7
	3	Y	862/2.0	593/1.9	372/1.8	2912/1.8	2053/1.7	946/1.5	10.7/2.7

Mounting Pattern Compatibility

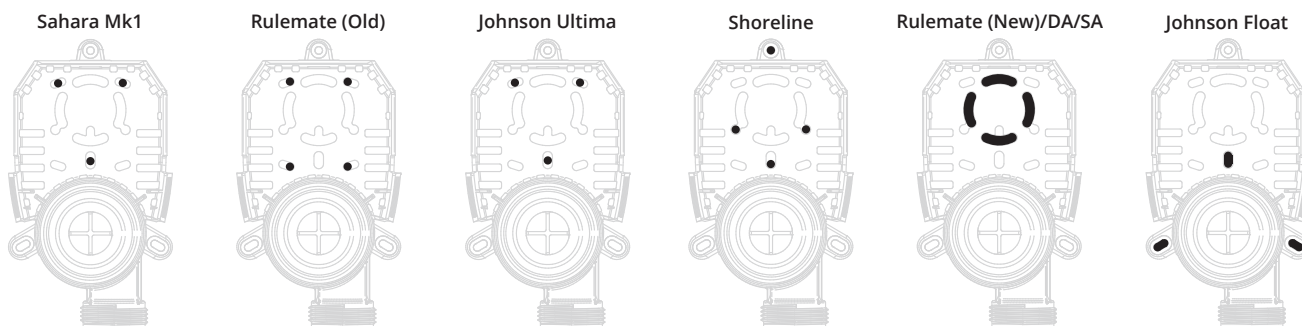



Bilge Pump Dimensions

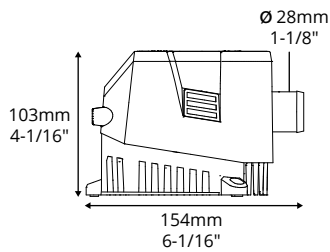
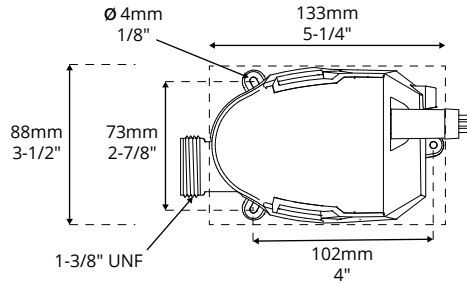

Sahara Mk2 1200 Barb

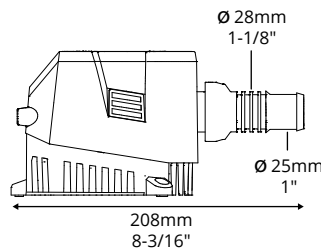

Sahara Mk2 1200 with Outlet - Straight

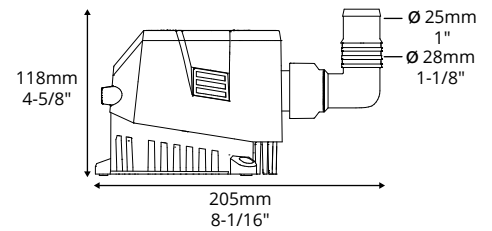

Sahara Mk2 1200 with Outlet - 90° Elbow

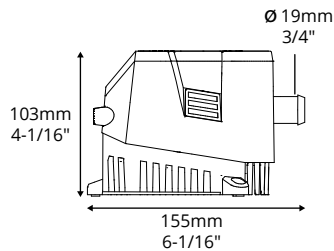

Sahara Mk2 500/800 Barb

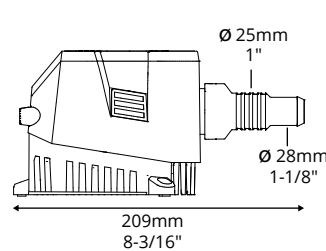

Sahara Mk2 500/800 with Outlet - Straight

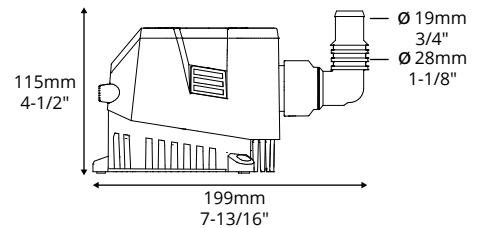

Sahara Mk2 500/800 with Outlet - 90° Elbow

Performance Charts

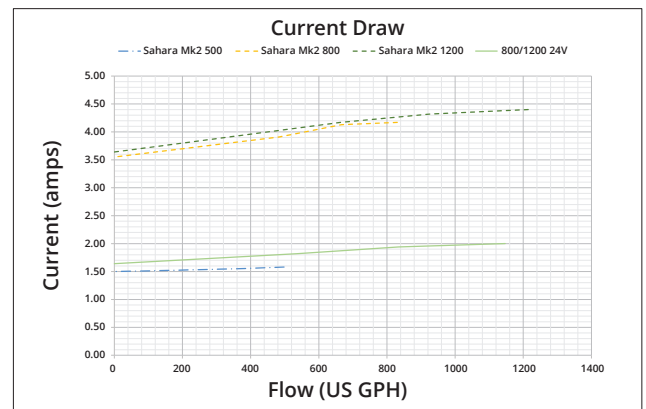
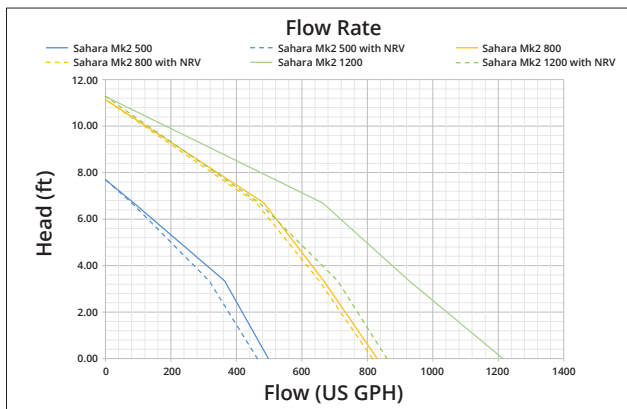

Heavy-Duty Bilge Pumps

Integrates the highest quality bearings, brushes, alloys and magnets designed to withstand extreme usage cycles. Pump also employs an exclusive shaft and motor compartment, reducing wear and significantly extending pump life. Advanced resin compositions incorporated into exterior to resist chemicals such as engine oil, aggressive detergents and hose plasticizers. Attwood's Heavy Duty Bilge has unsurpassed durability and efficiency in a compact design to ensure electrical energy is converted to the pump rather than excess heat. This pump is fully submersible.

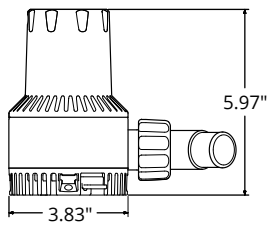
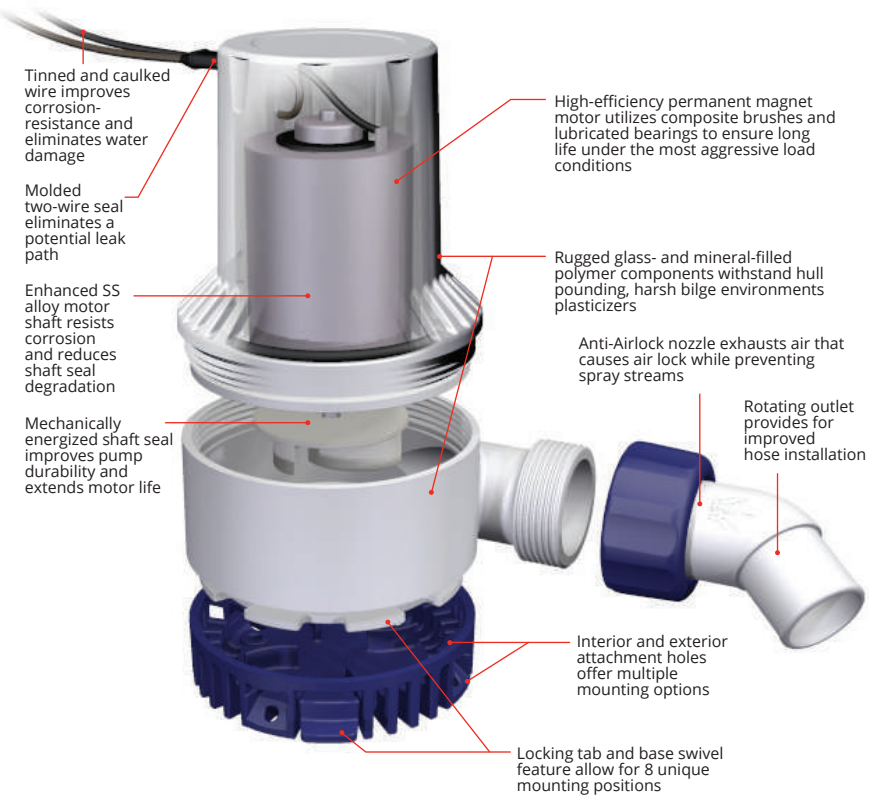

Specifications

Model No.	Rated Voltage	GPH Output @ Design Voltage 13.6V DC					GPH Output @ Nominal Voltage 12.0V DC					Fuse Size	Hose Size
		Amp Draw	0 ft	3.3 ft	6.7 ft	Max Head	Amp Draw	0 ft	3.3 ft	6.7 ft	Max Head		
HD1700	12V	5.7	1700	1300	950	12 ft	5.1	1500	1100	800	11 ft	10A	1-1/8" I.D.
HD2000	12V	6.6	2000	1600	1230	17 ft	6	1800	1500	1200	16 ft	12A	1-1/8" I.D.
	24V	3.5	2000	1600	1230	17 ft	2.9	1800	1500	1200	16 ft	7A	1-1/8" I.D.

HD1700 Pump

The perfect upgrade from 1500 GPH rated pumps, especially older, over-rated designs. Delivers a true 1700 GPH at open flow while drawing less than 6A.

Model No.	Rated Voltage	Wire/ Connector	OEM Part #	Part #
HD1700	12V	36" wire	4730-1	4730-4



HD 1700 Pump with Anti-Airlock nozzle

HD2000 Pump

Attwood's highest capacity bilge pump! Ball-bearing design provides for cooler motor operation and longer life. Delivers over 2000 GPH at open flow while drawing less than 7A.

Model No.	Rated Voltage	Wire/ Connector	OEM Part #	Part #
HD2000	12V	36" wire	4760-1	4760-4
	24V	36" wire	4770-1	4770-4



HD 2000 Pump with Anti-Airlock nozzle



Manual Bilge Pumps **NEW**

Tsunami Mk2 is the only manual bilge pump that eliminates air-locks

- Patented X-Air™ Impeller ejects trapped air in the pump and pipework.

Tsunami Mk2 is the easiest manual bilge pump to install and service

- Backwards compatible hole pattern and motor cartridges of Tsunami Mk1 bilge and aerator pumps.
- External mounting feet and integrated outlet reduces time and effort.
- Service pump cartridge from hard-to-reach areas using only one hand.

Tsunami Mk2 is the most reliable manual bilge pump in freshwater applications

- 40% better protection against water ingress and electrolysis - vs. Mk1.



Single-Hand Pump Cartridge Release:
Convenient when trying to access a pump located in a hard-to-reach area of the boat's hull.



Flexible Outlets: 90° rotatable elbow outlet allows users to install the pump anywhere in a full 360° orientation.



Exterior Mounting Feet:
Eliminates the need to remove the basket, saving OEMs time on production lines.

Certifications, Standards and Listings

The Tsunami Mk2 Manual Bilge Pumps meet or exceed the following U.S. and international certificates and standards:

Bilge pumps standards

- ABYC H-22
- ISO 8849
- ISO 15083

Ignition protection standards

- ISO 8846 Marine

Marine electrical wiring standards

- ABYC E-11
- ISO 10133
- U.S. Coast Guard Rule, 33CFR-183.425

Approvals

- NMMA "As approved listing"
- CE, RCM, UKCA



Patented X-Air™ Impeller:
Prevents air locking so that the pump will not run dry and burn out.

Model No.	Rated Volts DC	Fuse Size	Outlet Type	Check Valve	OEM Part #	OEM Outlet Straight	OEM Outlet 90°	Part #
T500	12V	3A	3/4" (19mm) & 1" (25mm) Barbs	Y	—	—	—	5606-7
	12V	3A	3/4" (19mm) Barb	N	5606B-1	—	—	—
	12V	3A	1-3/8" Threaded*	Optional	5606-1	AS5605S-1	AS5605E-1	—
T800	12V	5A	3/4" (19mm) & 1" (25mm) Barbs	Y	—	—	—	5608-7
	12V	5A	3/4" (19mm) Barb	N	5608B-1	—	—	—
	12V	5A	1-3/8" Threaded*	Optional	5608-1	AS5605S-1	AS5605E-1	—
T800	24V	2A	3/4" (19mm) & 1" (25mm) Barbs	Y	—	—	—	5609-7
	24V	2A	3/4" (19mm) Barb	N	5609B-1	—	—	—
	24V	2A	1-3/8" Threaded*	Optional	5609-1	AS5605S-1	AS5605E-1	—
T1200	12V	6A	1" (25mm) & 1-1/8" (28mm) Barbs	Y	—	—	—	5612-7
	12V	6A	1-1/8" (28mm) Barb	N	5612B-1	—	—	—
	12V	6A	1-3/8" Threaded*	Optional	5612-1	AS5612S-1	AS5612E-1	—
T1200	24V	3A	1" (25mm) & 1-1/8" (28mm) Barbs	Y	—	—	—	5613-7
	24V	3A	1-1/8" (28mm) Barb	N	5613B-1	—	—	—
	24V	3A	1-3/8" Threaded*	Optional	5613-1	AS5612S-1	AS5612E-1	—
Tsunami Mk2 Bilge Replacement Motor Cartridges								
T500	12V							5620-6
T800	12V							5622-6
T1200	12V							5624-6

Wire Length for all models 29" (735mm). *Must be used with appropriate Tsunami outlet.

Service Kits:

- AK5605-7 for T500 and T800
- AK5612-7 for T1200
- Service kits for Barb versions not available



5606



5608



5612

12 Volt Specifications

Model	Automotive Fuse Required (amps)	NRV Fitted	ABYC Specifications 13.6-volts DC (GPH=Gallons Per Hour)			ISO Specifications 12.0-volts DC (LPH=Liters Per Hour)			
			0 ft. Head GPH/amps	3.3 ft. Head GPH/amps	6.7 ft. Head GPH/amps	0m Head LPH/amps	1m Head LPH/amps	2m Head LPH/amps	Max Head (ft@13.6V/m@12V)
T500	3	N	536/1.7	334/2.2	200/2.1	1818/1.5	1156/1.5	0	7.6/1.8
	3	Y	510/1.8	311/2.2	186/2.1	1692/1.5	1116/1.5	0	7.6/1.8
T800	4	N	796/3.1	503/3.6	356/3.4	2682/2.6	2246/2.6	1554/2.6	14.2/3.5
	4	Y	747/3.2	482/3.5	341/3.3	2544/2.6	2076/2.6	1440/2.6	14.2/3.5
T1200	5	N	1155/3.9	789/4.5	565/4.3	4002/3.3	3007/3.4	1764/3.2	11.8/2.9
	5	Y	903/4.0	659/4.4	464/4.2	3124/3.4	2356/3.3	1364/3.0	11.8/2.9

24 Volt Specifications

Model	Automotive Fuse Required (amps)	NRV Fitted	ABYC Specifications 27.2-volts DC (GPH=Gallons Per Hour)			ISO Specifications 24.0-volts DC (LPH=Liters Per Hour)			
			0 ft. Head GPH/amps	3.3 ft. Head GPH/amps	6.7 ft. Head GPH/amps	0m Head LPH/amps	1m Head LPH/amps	2m Head LPH/amps	Max Head (ft@27.2V/m@24V)
T800	2	N	802/1.5	472/1.5	340/1.4	3036/1.5	2262/1.6	1977/1.5	14.8/3.5
	2	Y	737/1.6	454/1.5	322/1.4	2532/1.3	2046/1.3	1464/1.2	14.8/3.5
T1200	2	N	1106/1.8	698/1.9	474/1.8	3816/1.5	2817/1.5	1479/1.4	11.1/2.7
	2	Y	859/1.9	602/1.8	384/1.7	2946/1.6	2223/1.5	1203/1.4	11.1/2.7

Mounting Pattern Compatibility

Tsunami Mk1 500

Tsunami Mk1 800 / 1200

Johnson L Series

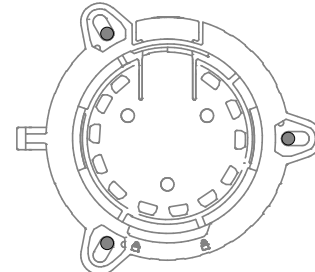
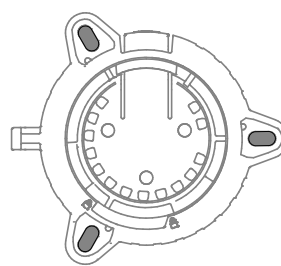
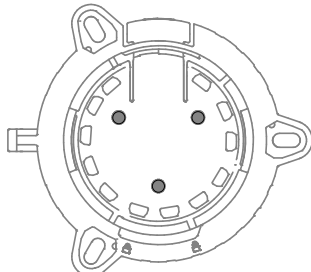
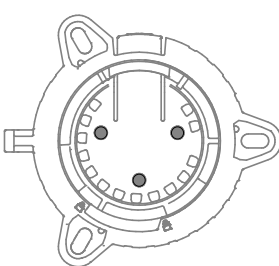



Bilge Pump Dimensions

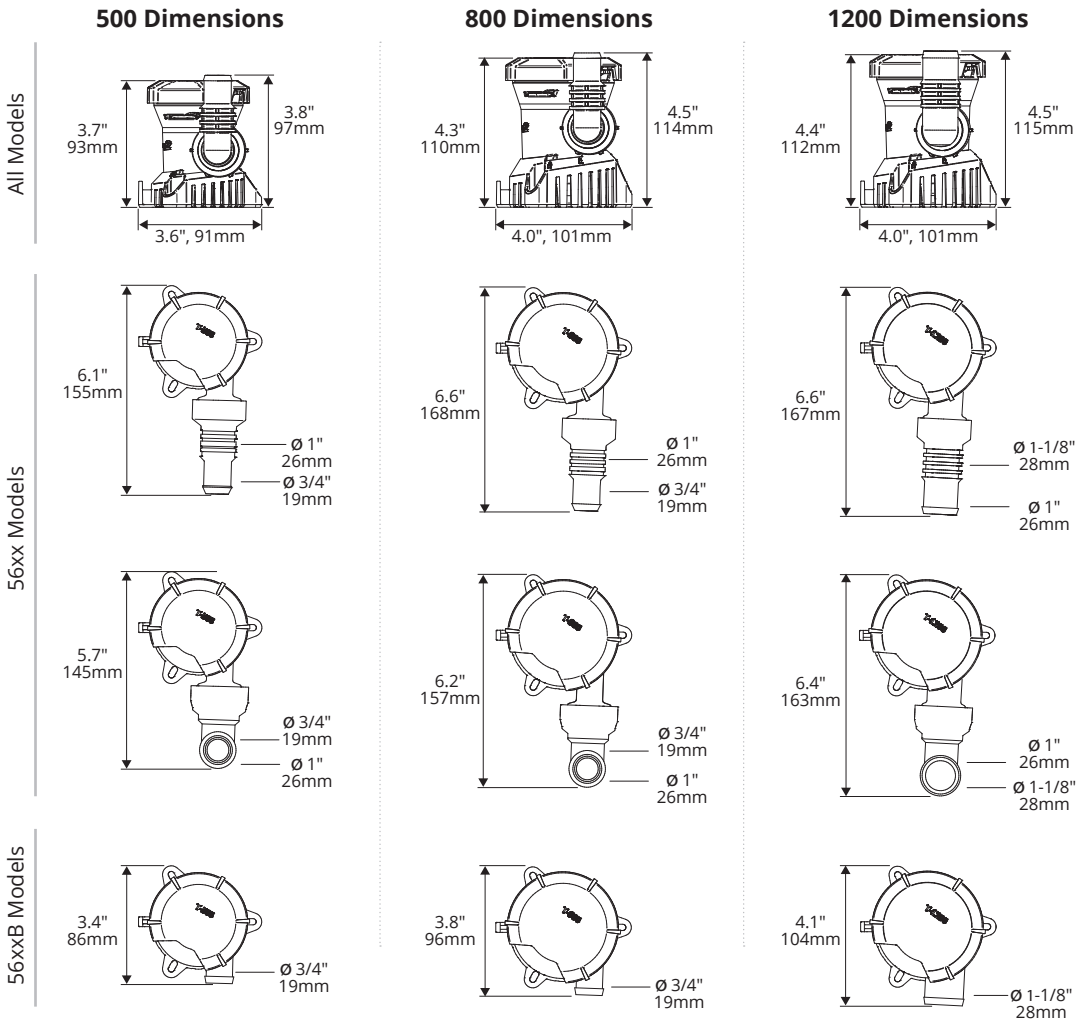

Performance Charts

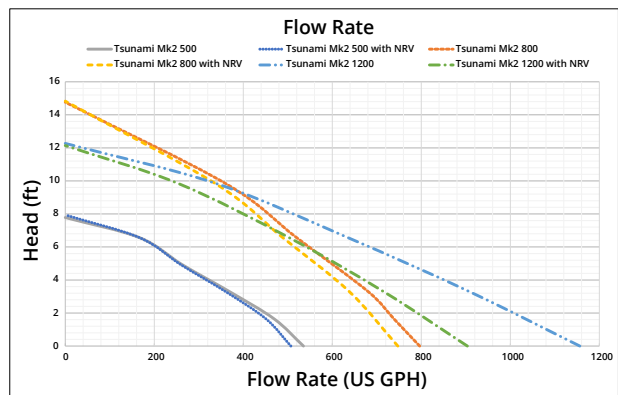
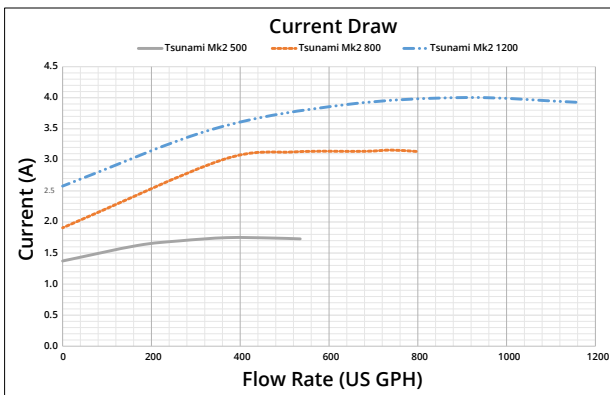

Aerator Pumps

Tsunami Mk2 Aerator Pumps NEW

Keep your bait and fish alive with the new Tsunami Aerator Mk2. Our leading fish-friendly technology is even easier to install and service, cutting costs for both suppliers and end users.

Flexible Installation

- Both 90 and straight inlets and outlets

Full Backwards Compatibility

- With previous Tsunami models

Faster, Smarter Installation

- With no sealant or tools required



Certifications, Standards and Listings

The Tsunami Mk2 pumps meet or exceed the following U.S. and international standards:

IP Rating:

- IP68

Ignition protection standards

- ISO 8846 Marine

Marine electrical wiring standards

- ABYC E-11
- ISO 10133

Approvals

- NMMA "As approved listing"
500 Aerator (2619644),
800 Aerator (2619645),
1200 Aerator (2619646)
- CE, RCM, UKCA



Model	Inlet Style	Inlet Length & Diameter	Application	OEM Part #	OEM Outlet Straight	OEM Outlet 90°	Part #
Tsunami Aerator Mk2 Pumps							
T500	Straight	3-1/2" L x 3/4"	Thru-Hull	5640-1	AS5605SS-1 (3/4" barb)	AS5605ES-1 (3/4" barb)	5640-4
		1-1/2" L x 3/4"	Thru-Hull	5641-1	—	—	—
	Elbow	7/8" L x 3/4"	Seacock	5643-1	AS5605QLS-1 (3/4" Qwik-Lok™)	AS5605QLE-1 (3/4" Qwik-Lok™)	5643-4
T800	Straight	3-1/2" L x 3/4"	Thru-Hull	5644-1	—	—	5644-4
		1-1/2" L x 3/4"	Thru-Hull	5650-1	AS5605SS-1 (3/4" barb)	AS5605ES-1 (3/4" barb)	5650-4
	Elbow	7/8" L x 3/4"	Seacock	5653-1	AS5605QLS-1 (3/4" Qwik-Lok™)	AS5605QLE-1 (3/4" Qwik-Lok™)	5653-4
		3-1/2" L x 3/4"	Thru-Hull	5654-1	—	—	5654-4
T1200	Straight	3-1/2" L x 1-1/8"	Thru-Hull	5660-1	AS5612SS-1 (1-1/8" barb)	AS5612ES-1 (1-1/8" barb)	5660-4
		1-1/2" L x 1-1/8"	Thru-Hull	5661-1	—	—	—
	Elbow	7/8" L x 1"	Seacock	5663-1	AS5605QLS-1 (3/4" Qwik-Lok™)	AS5605QLE-1 (3/4" Qwik-Lok™)	5663-4
		3-1/2" L x 1-1/8"	Thru-Hull	5664-1	—	—	5664-4
Tsunami Mk2 Aerator Replacement Motor Cartridges							
T500				—	—	—	5620-6
T800				—	—	—	5622-6
T1200				—	—	—	5624-6

All models are 12 volt D.C. with wire length of 29" (735mm). Second outlet thread 1/2" NPT Female.

Service Kits:

- AK5605S-7 for T500 and T800, Straight and Elbow short 3/4" outlets with Washer
- AK5612S-7 for T1200, Straight and Elbow short 1-1/8" outlets with Washer
- AK5670-7 for all models, second outlets, Straights and Elbows 1/2", 3-4" & 1"

Specifications

Model	Hole Saw Size	Amp Fuse	Outlet Diameter	ABYC Specifications 13.6-volts DC (GPH=Gallons Per Hour)			ISO Specifications 12.0-volts DC (LPH=Liters Per Hour)		
				0 ft. Head GPH/amps	3.3 ft. Head GPH/amps	6.7 ft. Head GPH/amps	0m Head LPH/amps	1m Head LPH/amps	Max Head (ft. @ 13.6V/m @ 12V)
564X / T500	1-1/8"	3A	3/4" barb	507 / 1.6	319 / 1.7	192 / 1.6	1764 / 1.4	1182 / 1.4	10.4 / 2.6
565X / T800	1-1/8"	4A	3/4" barb	793 / 3	498 / 2.9	371 / 2.9	2694 / 2.5	2142 / 2.5	17.4 / 4.2
566X / T1200	1-3/8"	5A	1-1/8" barb	1143 / 3.9	748 / 3.9	527 / 3.8	3912 / 3.3	3282 / 3.3	14.8 / 3.8



Aerator Pump Dimensions

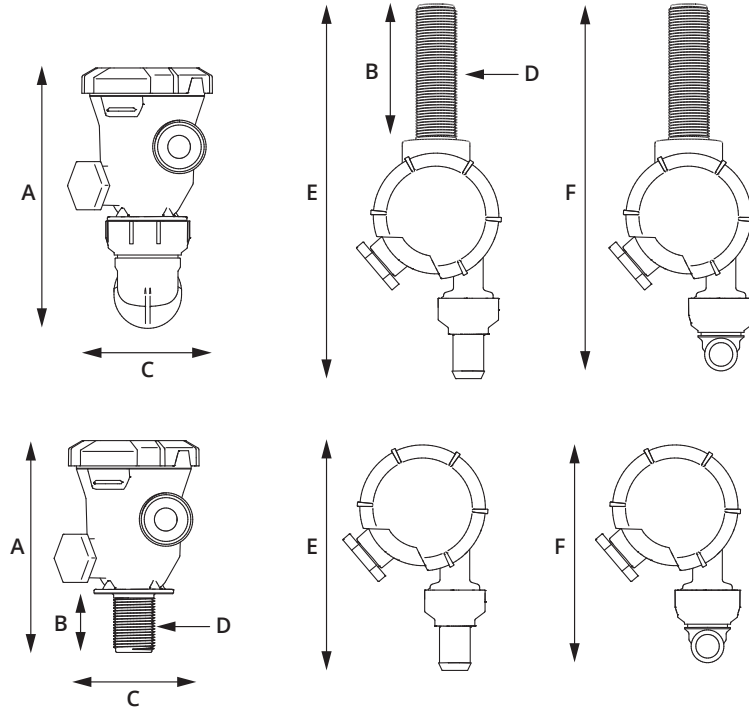

Model	Product Code	A	B	C	D	E	F
500	Long 5640	6.8" 172 mm	3.5" 88 mm	3.4" 86 mm	3/4 NPS	5.3" 134 mm	5.1" 129 mm
	Short 5641	4.8" 122 mm	1.5" 38 mm	3.4" 86 mm	3/4 NPS	5.3" 134 mm	5.1" 129 mm
	Seacock 5643	4.2" 106 mm	0.85" 21.6 mm	3.4" 86 mm	3/4 NPT	5.3" 134 mm	5.1" 129 mm
	Elbow 5644	6.1" 154 mm	3.5" 88 mm	3.4" 86 mm	3/4 NPS	9.3" 235 mm	9.1" 231 mm
800	Long 5650	7.4" 188 mm	3.5" 88 mm	3.7" 94 mm	3/4 NPS	5.8" 147 mm	5.6" 142 mm
	Short 5651	5.5" 138 mm	1.5" 38 mm	3.7" 94 mm	3/4 NPS	5.8" 147 mm	5.6" 142 mm
	Seacock 5653	4.8" 122 mm	0.85" 21.6 mm	3.7" 94 mm	3/4 NPT	5.8" 147 mm	5.6" 142 mm
	Elbow 5654	6.7" 170 mm	3.5" 88 mm	3.7" 94 mm	3/4 NPS	9.6" 244 mm	9.4" 239 mm
1200	Long 5660	7.5" 190 mm	3.5" 88 mm	3.8" 95 mm	1-3/8" UNF	5.5" 140 mm	5.8" 146 mm
	Short 5661	5.5" 140 mm	1.5" 38 mm	3.8" 95 mm	1-3/8" UNF	5.5" 140 mm	5.8" 146 mm
	Seacock 5663	4.9" 125 mm	0.9" 23 mm	3.8" 95 mm	1" NPT	5.5" 140 mm	5.8" 146 mm
	Elbow 5664	6.9" 175 mm	3.5" 88 mm	3.8" 95 mm	1-3/8" UNF	9.4" 238 mm	9.5" 242 mm

Performance Charts

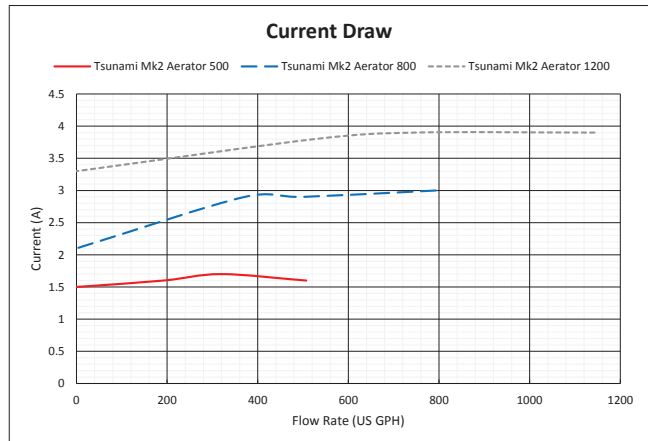
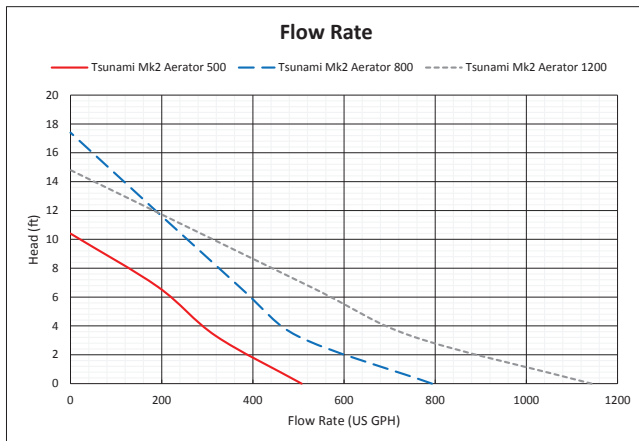

Bilge & Float Switches

S3 Series Automatic Bilge Switches

Incorporates a proprietary Electronic Sensing technology to detect bilge water levels and trigger pump activation and has been engineered to operate in any bilge water mixture consistently without failure. Your pump won't be exposed to continuous cycling as the S3 switch can easily distinguish splashing bilge water, chemicals, sludge build up or foam, and comes equipped with fully sealed electronics that are completely protected from water or chemical damage. For added convenience, the bilge switch can be mounted on the floor of the bilge, directly to a stringer wall, or alongside the basket of the pump without added components or brackets. The S3 Series switch is also directly compatible with all competitive products and free of moving parts that can jam up, break or wear out over time. Marine ignition protected and RoHS compliant.



4801

Description	Max. Pump Amp Draw	Rated Voltage	Wire	OEM Part #	Part #
Switch, White	15A	12V	36" wire	4801-1	4801-7

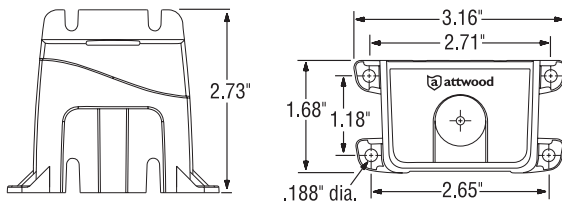

Automatic Float Switches

Converts bilge pumps to fully automatic operation. Maximum amp draw is 12A (at 12V DC) or 6A (at 24V DC). Features a compact, low-profile design that mounts on any surface from horizontal up to a 24° angle. Incorporates a reliable and affordable mechanical switch that actuates pump motor at 2" water level. Wire leads do not flex or hinge with the float as on some competitive models. Integral cover dampens bilge sloshing to reduce pump cycling, and prevents debris interference. Sealed switch mechanism resists moisture, fume-ignition, and electrical shock. Contains no mercury, which is listed as a health hazard and "Persistent Toxic Substance" in over 26 states. Marine ignition protected and RoHS compliant.

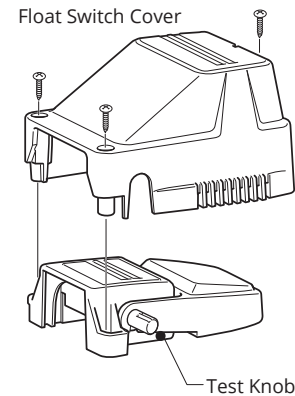

Float Switch with Cover

Description	Rated Voltage	Wire/Connector	OEM Part #	Part #
Float switch with cover	12V and 24V CE rated	36" wire	4201-1	4201-7

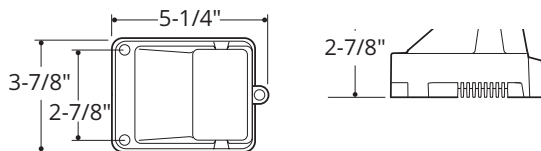

4201

Float Switch

Description	Rated Voltage	Wire/Connector	OEM Part #	Part #
Float switch	12V and 24V CE rated	36" wire	4202-1	4202-7

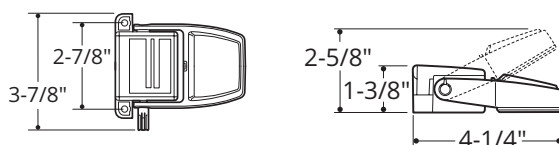

4202

Sump Boxes

Shower Sump Pump Systems

Attwood's shower sump systems deliver the performance you've been asking for. Choose from standard box or large box sizes. Offering fast water flow into and out of sump. The lid snaps in to allow quick installation (and removal for cleaning) and includes a gasket to seal the sump box against overflow. The sump box even includes an air vent to prevent air locks. Meets or exceeds all applicable standards of the ABYC and USCG.

Model No.	Rated Voltage	Fuse Size	Outlet Hose Size	Wire/Connector	Box Size	OEM Part #	Part #
500 GPH	12V	3A	3/4" I.D.	22" wire	Standard	4141-1	4141-4
750 GPH	12V	5A	3/4" I.D.	22" wire	Standard	4142-1	—
750 GPH	12V	5A	3/4" I.D.	22" wire	Large	4143-1	4143-4
750 GPH	24V	2A	3/4" I.D.	22" wire	Large	4144-1	—
750 GPH	24V	2A	3/4" I.D.	22" wire	Standard	4145-1	—
Lid					Standard	001001668	—
Lid					Large	001001667	—



4141



4143

Output Ratings

Model	Amp Draw	GPH Output @ Design Voltage 13.6V DC			GPH Output @ Nominal Voltage 12.0V DC		
		0 ft	3.3 ft	6.7 ft	0 ft	3.3 ft	6.7 ft
500 GPH	1.4	420	360	215	385	290	130
750 GPH	2.5	650	500	385	570	420	290

Performance for 24V version is the same (Uses 2 Amp Fuses)

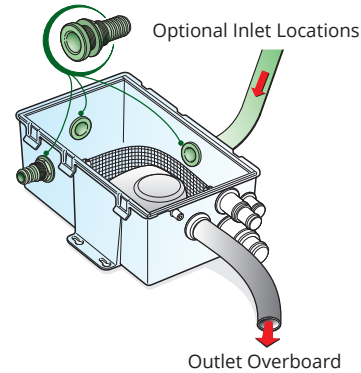
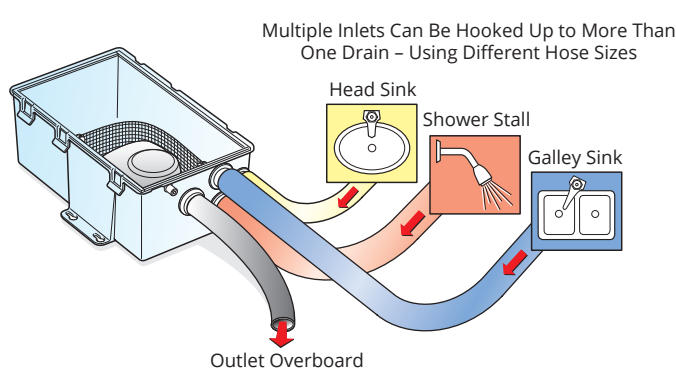

Shower Sump Pump Systems Dimensions

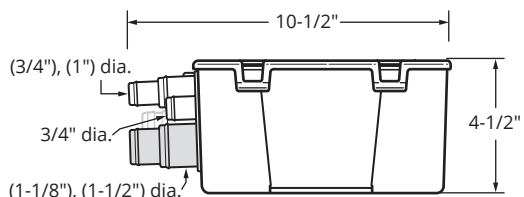
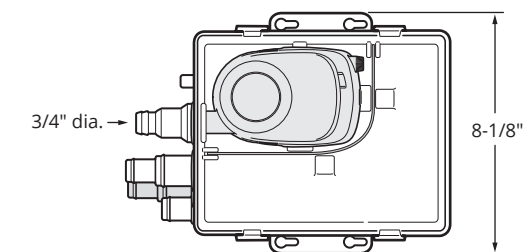

Standard Box

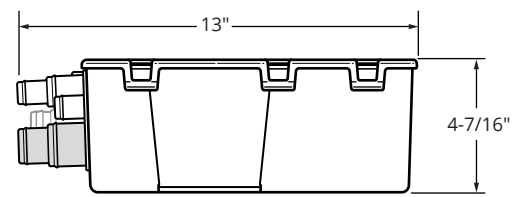
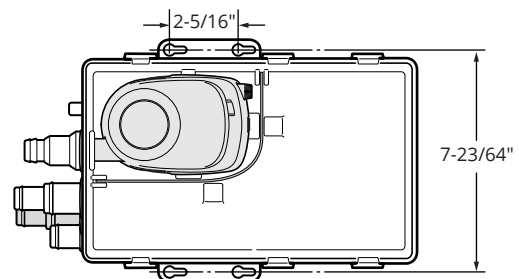

Large Box

Shower Systems



Hot/Cold Aft-Deck Shower

Install flush in the transom or under the gunwale. Includes hinged cover and replaceable sprayer head. Fixtures are corrosion-resistant. Housing and cover are made of high-impact, UV resistant, engineering-grade plastic and are pre-drilled for six #8 fasteners. Comes with 6' hose, shut-off, and hot/cold mixing controls. Connects to freshwater system for showering.

OEM Part #	Part #
4131-1	4131-4

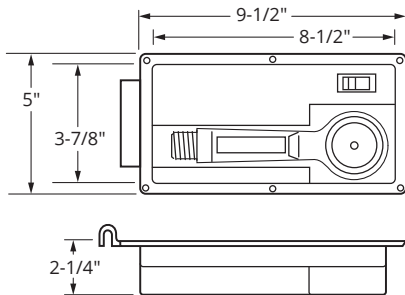

Cold Water Shower

Install flush in the transom or under the gunwale. Includes hinged cover and replaceable sprayer head. Fixtures are corrosion-resistant. Housing and cover are made of high-impact, UV resistant, engineering-grade plastic and are pre-drilled for six #8 fasteners. Hand-held shower sprayer with 6' hose and shut-off. Connects to freshwater system or self-priming wash-down pump for showering after swimming. Built-in on/off switch for pump.

OEM Part #	Part #
4133-1	—

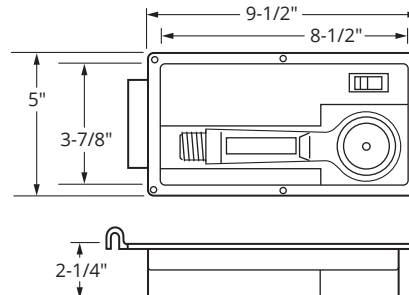

Battery & Hand Operated Pumps

WaterBuster® Portable Pump

This submersible pump is a great way to remove unwanted water from boats, pool covers, aquariums and sump pits. Convenient and safe because it needs no electrical cord — runs up to five hours on three alkaline "D" batteries. Excellent for use as a portable pump-out device for paddle boats, inflatables, duck boats, dingies or kayaks, any craft that lacks a hard-wire, permanent electrical system.

- 6-3/8" high x 5-1/4" diameter
- Pumps up to 200 gallons per hour
- Includes 42" hose with garden hose adapter for adding longer hose
- Lifts water to height of 40"

Note: Not to be used as a permanent bilge pump

GPH Open Flow	GPH 2 ft Head †	OEM Part #	Part #
200	125	—	4140-4

† 4 ft maximum head





Kayak Hand Bilge Pump

Safely remove unwanted water, or other liquids, from kayaks and other small boats. 18".

OEM Part #	Part #
—	11595-2



Hand Bilge Pump

Safely remove unwanted water, or other liquids, from small boats. 24", 32" Hose.

OEM Part #	Part #
—	11596-2

Pump Kits & Accessories

Tsunami Mk2 Recirc Aerator Kit

The Tsunami Recirc Kit recirculates livewell water to keep it cooler and rich in oxygen. This self-contained system feeds a separate aerator spray head and works even while you are underway and cannot use a thru-hull connection. Add this kit to any tank that already has a freshwater fill system. Or use as a backup pump for a fail-safe system.

Recirc Kit includes:

- (1) 500 GPH Tsunami aerator pump with short inlet, threaded outlet
- (1) 4125-1 aerator spray head
- (1) 4232-1 Stainless Steel strainer
- (2) Plastic hose clamps
- (1) 3/4" diameter x 23" long poly hose
- (1) Straight thread-to-barb connector



5253

OEM Part #	Part #
—	5253-4

Tsunami Mk2 Bilge Pump Installation Kits

Complete kit to install manual bilge pump with 3/4" I.D. hose outlet.

- (1) 2-way on/off switch with bezel plate
- (1) 3/4" I.D. x 5' corrugated hose
- (1) Thru-hull fitting for 3/4" I.D. hose
- (2) Snap-It hose clamps
- (1) 2-conductor 16-gauge wire, 20' long
- (1) In-line fuse holder with 2A fuse

Caution: Bilge pump switches are not external ignition protected.



4116

Description	Hose Size	OEM Part #	Part #
Complete kit (without pump)	3/4" I.D.	—	4116-5
Complete kit with Tsunami Mk2 T-500 bilge pump	3/4" I.D.	—	5614-7
6' hose with (2) clamps	3/4" I.D.	—	4199-7
6' hose only	1-1/8" I.D.	—	11551-5

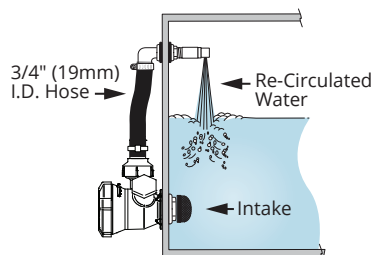

5614

Bilge Switches

- On/off switch with bezel plate

Description	Part #
Bilge Switch 2-way	7615-3
Bilge Switch 3-way	7615A-3



7615

Aerator Remote Mounting Brackets

For mounting the aerator pump to a base, away from the transom.

Description	OEM Part #	Part #
1-1/8" Aerator remote mounting bracket	4121-1	4121-3
3/4" Aerator remote mounting bracket	4122-1	4122-3

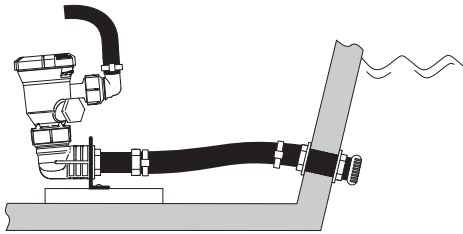

4121

4122

Aerator Spray Heads

For use on livewells that have built-in overflows or recirculating systems.

Adjustable Spray Heads

Mounts on sides of tank. 90° fitting for installation in tight spaces. Rotating head with O-ring adjusts and maintains flow setting. Removable head has an "interference-fit thread design" that will not allow it to vibrate or blow out. Polypropylene construction. Can be installed on tanks with up to 5/8" wall thickness.



4125

Non-Adjustable Spray Heads

Multi-port spray maximizes oxygen level in the livewell. Constructed of ABS plastic. Double Valve Spray Head - Allows aerating options - one end can be used for freshwater fill, the other end with a recirculating pump. Single Valve Spray Head - For output from an aerator pump into the livewell.



4123

Description	Hose I.D.	OEM Part #	Part #
Adjustable Spray Heads			
Aerator spray head	3/4"	4125-1	4125-7
Aerator spray head w/male connector for Flow-Rite™ Qwik-Lok™ Coupler 3	3/4"	4123-1	—
Non-Adjustable Spray Heads			
Aerator spray head, single valve	3/4"	4118A1	4118A5



4118A

Check Tees

These check tees replace additional connections for RV and marine hookups, providing a combination check valve and tee that allows water to flow in from the dockside connection without filling the tank. Constructed of ABS plastic.

Combination Barbed Fitting

Inlet and outlet both have combination fittings: Comes with 3/8" barbs that can be removed to accommodate 1/4" NPT fitting, 1/2" NPT fitting for dockside water connection.

Description	OEM Part #	Part #
Combination barbed fitting	6115-1	—



6115

Plumbing System Fittings



Snap-It Hose Clamps

Use on bilge pumps and shower sump systems. Corrosion-resistant plastic.

Note: Clamps are intended for water and waste system hoses only.

Hose O.D.	Hose I.D.	OEM Part #	Part #
7/8" to 1"	3/4"	9185J1	—



Tees

Three-way 90° fitting. Acetal construction.

Hose I.D.	OEM Part #	Part #
3/4"	3892-1	—



Thread-to-Barb Connector

Barbed end accommodates 3/4" I.D. hose. 3/4"-14 NPSM and 3/4" I.D. hose fitting. Threaded end fits 3888 drain fitting, A-Series aerator pump outlets and Tsunami threaded outlets. Acetal construction.

Use With	OEM Part #	Part #
500-800 GPH pumps	3899-1	3899-3



Thread-to-Flow-Rite™ Quick-Lok™ Connector

Barbed end accommodates 3/4" I.D. Threaded end fits 3888 drain fitting, A-Series aerator pump outlets and Tsunami threaded outlets. Acetal construction.

Use With	OEM Part #	Part #
500-800 GPH pumps	3909-1	—



90° Thread-to-Barb Connector

Threaded female end fits 3888 drain fitting, Tsunami 46xx series aerator and bilge pump outlets and Tsunami Aerator Mk2 inlets. Barbed end accommodates 3/4" I.D. hose. Acetal construction. For 3/4"-14 threads and 3/4" I.D. hose.

Use With	OEM Part #	Part #
500-800 GPH pumps	3890-1	3890-3



90° Thread-to-Flow-Rite™ Quick-Lok™ Connector

Threaded female end fits 3888 drain fitting, Tsunami 46xx series aerator and bilge pump outlets and Tsunami Aerator Mk2 inlets. Male end accommodates Flow Rate™ Qwik-Lok™ Coupler.

Use With	OEM Part #	Part #
500-800 GPH pumps	3900-1	—

Stainless Steel Thru-Hulls & Scupper Valve Fittings

Polish your image with these beautiful, durable stainless steel fittings. Each Thru-Hull and Scupper Valve is available with a new silicone gasket and are backed by Attwood's trusted Lifetime Warranty! Why specify plastic parts when these fittings will last the life of the boat?

Rugged Stainless Construction

- Cast from certified Enhanced 316 Stainless Steel alloy for strength and lifetime corrosion-resistance
- We polish all visible areas to a mirror finish, then passivate each part for additional protection
- Thick steel sidewalls withstand continual stress and hose flexing

Faster, Simpler Installation

- A channel under the flange holds a bead of sealant, making it easier to apply a trouble-free seal
- All models have wrench flats or an end notch to hold as a gripping surface. One installer can tighten all connections from inside the hull
- Barbed tail ends provide plenty of room to hold multiple clamps

Stainless Steel Straight Thru-Hulls, Barbed

- Standard Thread model has full-length thread for thick hulls and easy tightening
- Short Thread is a more compact size. Allows installation near corners and in confined areas.

Caution: Stainless Steel Scupper Valves are designed for installation above the water line only.

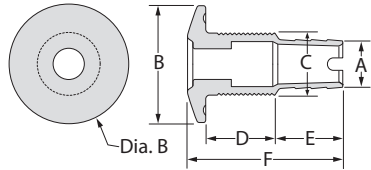

Short Length

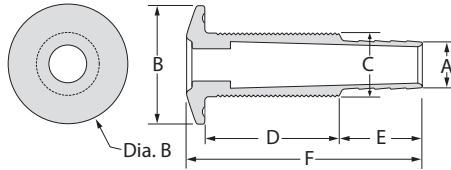

Standard Length

A Hose Size	B Flange Dia.	C Thread O.D.	D Thread Length	E Barb Length	F Total Length	Install. Hole Saw Size	Thread NPSM	Max Hull Thick.	OEM Part # without Gasket	Part #
Short Length										
5/8" I.D.	1-7/8"	1"	1"	1"	2-1/4"	1-1/8"	3/4"	5/8"	66540-1	66540-3
3/4" I.D.	1-7/8"	1"	1"	1"	2-1/2"	1-1/8"	3/4"	5/8"	66541-1	66541-3
1" I.D.	2-1/4"	1-3/8"	1-1/8"	1"	2-1/2"	1-1/2"	1"	5/8"	66542-1	66542-3
1-1/8" I.D.	2-1/4"	1-3/8"	1-1/4"	1"	2-1/2"	1-1/2"	1"	5/8"	66543-1	66543-3
1-1/4" I.D.	2-1/4"	1-5/8"	1-1/4"	1"	2-5/8"	1-3/4"	1-1/4"	5/8"	66544-1	66544-3
1-1/2" I.D.	3"	1-7/8"	1-1/4"	1-1/2"	3-1/8"	2"	1-1/2"	5/8"	66545-1	66545-3
Standard Length										
5/8" I.D.	1-7/8"	1"	2"	1-1/4"	3-3/4"	1-1/8"	3/4"	1-1/16"	66546-1	66546-3
3/4" I.D.	1-7/8"	1"	2"	1-1/4"	3-3/4"	1-1/8"	3/4"	1-5/8"	66547-1	66547-3
1" I.D.	2-1/4"	1-3/8"	2-1/4"	1-1/4"	3-7/8"	1-1/2"	1"	1-3/4"	66548-1	66548-3
1-1/8" I.D.	2-1/4"	1-3/8"	2-3/8"	1-1/4"	3-7/8"	1-1/4"	1"	1-3/4"	66549-1	66549-3
1-1/4" I.D.	2-1/4"	1-5/8"	2-1/2"	1-1/4"	4-1/4"	1-3/4"	1-1/4"	1-7/8"	66550-1	66550-3
1-1/2" I.D.	3"	1-7/8"	2-1/2"	1-1/4"	4-1/8"	2"	1-1/2"	1-7/8"	66551-1	66551-3
2" I.D.	3"	2-3/8"	2-1/2"	1-3/4"	4-5/8"	2-1/2"	1-1/2"	2"	66552-1	—



66540G



66542



66546G



66548

Stainless Steel Straight Thru-Hulls, Threaded

- Unique multi-thread design with NPSM and NPT threads
- Offer generous thread length
- Allows for direct connection to seacocks or pipes

Caution: Stainless Steel Thru-Hull Connectors are designed for installation above the water line only.

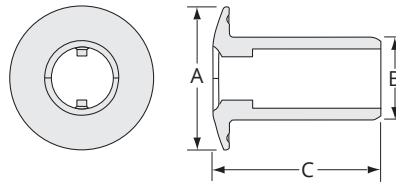

A Flange Dia.	B Thread O.D.	C Total Length	Installation Hole Saw Size	Threads NPSM	Max Hull Thickness	OEM Part # without Gasket	Part #
1-7/8"	2-1/8"	2-1/2"	1-1/8"	3/4"	1-5/8"	66559-1	—
2-1/4"	2-1/4"	2-5/8"	1-3/8"	1"	1-3/4"	66561-1	—
3"	2-3/8"	2-3/4"	2"	1-1/2"	1-7/8"	66563-1	—

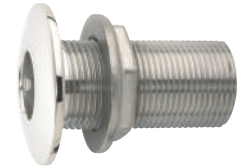

66559



66558G

Stainless Steel 90° Thru-Hulls, Barbed

Allows installation in especially tight spaces.

Caution: Stainless Steel Thru-Hull Connectors are designed for installation above the water line only.

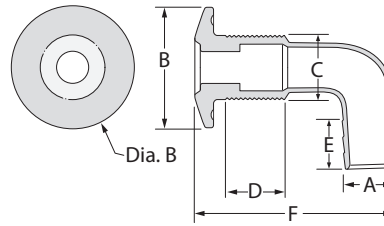

A Hose Size	B Flange Dia.	C Thread O.D.	D Thread Length	E Barb Length	F Total Length	Install. Hole Saw Size	Thread NPSM	Max Hull Thick.	OEM Part # without Gasket	Part #
3/4" I.D.	1-7/8"	1"	1-1/2"	3/4"	3-3/8"	1-1/4"	3/4"	1-1/16"	66577-1	—
1-1/8" I.D.	2-1/4"	1-3/8"	1-7/8"	3/4"	4-3/8"	1-5/8"	1"	1-1/4"	66579-1	—



66577

Stainless Steel Scupper Valves

- The Scupper Flap is tough neoprene rubber with a molded V that fits into the grooved body to reduce backwash
- Fasteners are concealed and corrosion-proof
- Enhanced 316 Stainless Steel Alloy

Caution: Stainless Steel Scupper Valves are designed for installation above the water line only.

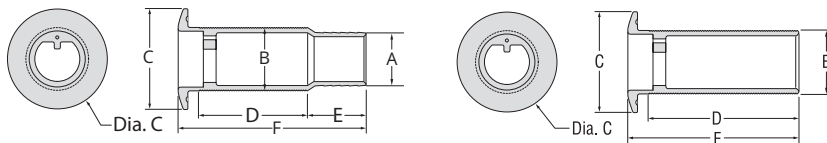

A Hose Size	B Thread Dia.	C Flange O.D.	D Thread Length	E Barb Length	F Total Length	Install. Hole Saw Size	Thread NPSM	Max Hull Thick.	OEM Part # without Gasket	Part #	
Threaded											
—	1-7/8"	3"	3-1/2"	—	3-7/8"	2"	1-1/2"	3"	66565-1	—	
—	2-23/64"	3-5/8"	2-1/2"	—	2-7/8"	2-1/2"	2"	2"	66567-1	—	
Barbed											
1-1/2"	1-7/8"	3"	3-1/2"	1-1/2"	5-1/2"	2"	1-1/2"	3"	66553-1	66553-3	
2"	2-23/64"	3-5/8"	2-1/2"	1-5/16"	4-1/2"	2-1/2"	2"	2"	66555-1	—	
1-1/2"	3"	1-7/8"	2-1/4"	1-1/2"	4-1/2"	2"	1-1/2"	1-3/4"	66557-1	—	
Valve Accessories									BULK		
Replacement Flappers for 1-1/2"									66553Kit		—
Replacement Flappers for 2"									66555Kit		—

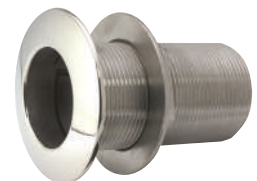

66565



66557G

Stainless Steel Narrow Flange Thru-Hulls

- Consistent exterior appearance throughout a range of barb sizes
- Modern styling
- Enhanced 316 Stainless Steel Alloy

Caution: Stainless Steel Thru-Hull Connectors are designed for installation above the water line only.

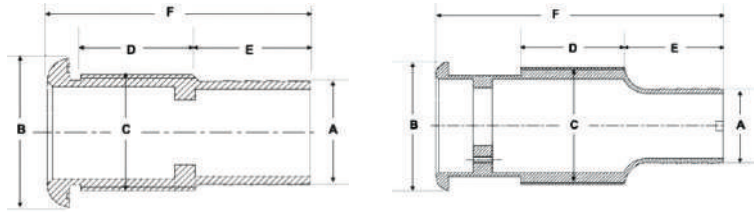

Thru-Hull

Scupper Valve

A Hose Size	B Flange Dia.	C Thread O.D.	D Thread Length	E Barb Length	F Total Length	Install. Hole Saw Size	Thread NPSM	Max Hull Thick.	OEM Part # without Gasket	Part #
Thru-Hulls, Standard Length										
5/8" I.D.	1-7/10"	1-3/10"	1-2/5"	1-1/8"	3"	1-5/16"	1"	7/8"	67555-1	—
3/4" I.D.	1-7/10"	1-3/10"	1-3/10"	1-1/4"	3"	1-5/16"	1"	3/4"	67554-1	—
1" I.D.	1-7/10"	1-3/10"	1-2/5"	1-1/8"	3"	1-5/16"	1"	7/8"	67556-1	—
1-1/8" I.D.	1-7/10"	1-3/10"	1-1/4"	1-1/8"	2-7/8"	1-5/16"	1"	3/4"	67557-1	—
1-1/2" I.D.	2-2/5"	1-7/8"	1-1/2"	1-3/5"	3-2/5"	2"	1-1/2"	1"	67551-1	—
2" I.D.	3.13"	2-3/8"	2.93"	2.04"	6.09"	2-7/16"	2"	2.70"	67552-1	—
Thru-Hulls, Long Length										
3/4" I.D.	1-7/10"	1-3/10"	1-1/2"	1-1/8"	4-1/4"	1-5/16"	1"	—	67558-1	—
1-1/8" I.D.	1-7/10"	1-3/10"	1-1/2"	1-1/8"	4-1/4"	1-5/16"	1"	—	67561-1	—
1-1/2" I.D.	2-2/5"	1-7/8"	1-1/2"	1-7/16"	4-15/16"	2"	1-1/2"	—	67562-1	—
Scupper Valve										
1-1/2" I.D.	2-3/5"	1-7/8"	2"	2"	5-3/4"	2-1/8"	1-1/2"	2-3/4"	67553-1	—



67555



67556



67551



67553

Stainless Steel Exhaust Thru-Hulls

- Specifically designed for generator and engine exhaust applications
- Features unique, modern styling that is both elegant and functional
- Stainless steel scupper valve and an integrated stainless drip ring
- Enhanced 316 Stainless Steel Alloy

Caution: Stainless Thru-Hull Connectors are designed for installation above the water line only.

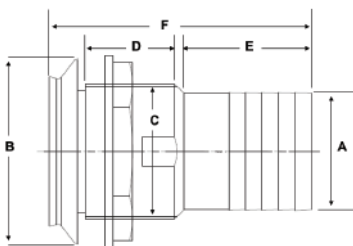

67581



67582

A Hose Size	B Flange Dia.	C Thread O.D.	D Thread Length	E Barb Length	F Total Length	Install. Hole Saw Size	Thread NPSM	Max Hull Thick.	OEM Part # without Gasket	Part #
1-1/2" I.D.	3.18"	2.26"	1.6"	1.97"	4.58"	2.375"	2" - 11-3/4	1.125"	67581-1	—
2" I.D.	3.18"	2.26"	1.6"	2.23"	4.58"	2.375"	2" - 11-3/4	1.125"	67580-1	—
2-1/2" I.D.	4.60"	3.375"	1.8"	2.75"	5.8"	3.625"	3" - 8	1.5"	67583-1	—
3" I.D.	4.60"	3.375"	1.8"	3"	5.8"	3.625"	3" - 8	1.5"	67582-1	—

Stainless Steel Capped Composite Thru-Hulls

Designed for the value conscious customer, these fittings provide the look of a Stainless Steel thru-hull at a fraction of the cost

Corrosion Resistance

Manufactured with high quality stainless steel caps and engineered composite bodies, these thru-hulls are designed to resist degradation as a result of chemical and saltwater exposure.

Consistent Look

To create a uniform look, Attwood has designed its 5/8" thru 1-1/2" barbed thru-hulls with a common exterior surface.

Improved Installation

Always keeping the builder in mind, each fitting incorporates several different types of assembly features that allow for "single operator" installation.

Caution: Stainless Steel Thru-Hull Connectors are designed for installation above the water line only.

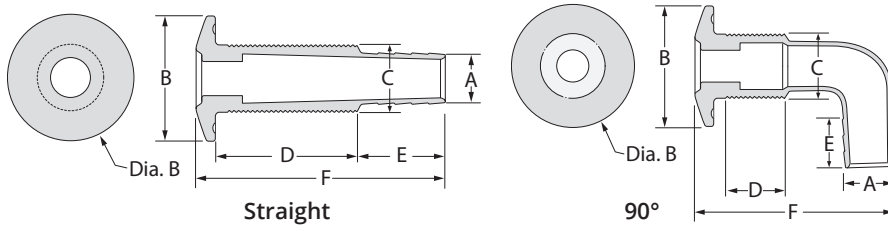

68555



68557



68576

A Hose Size	B Flange Dia.	C Thread O.D.	D Thread Length	E Barb Length	F Total Length	Installation Hole Saw Size	Max Hull Thickness	OEM Part #	Part #
Thru-Hulls, Straight									
5/8" I.D.	1-7/8"	1.27"	1.54"	1"	3.39"	1-3/8"	1.30"	68555-1	—
3/4" I.D.	1-7/8"	1.27"	1.54"	1"	3.36"	1-5/16"	1.30"	68554-1	—
1" I.D.	1-7/8"	1.27"	1.54"	1"	3.39"	1-5/16"	1.30"	68556-1	—
1-1/8" I.D.	1-7/8"	1.27"	1.54"	1.3"	3.36"	1-5/16"	1.30"	68557-1	—
1-1/2" I.D.	2-3/8"	1.5"	1.54"	1.6"	3"	1-1/2"	1.40"	68551-1	—
Thru-Hulls, 90°									
5/8" I.D.	1-7/8"	1.27"	1.54"	0.875"	3.48"	1-5/16"	1.30"	68576-1	—
3/4" I.D.	1-7/8"	1.27"	1.54"	1"	3.48"	1-5/16"	1.30"	68577-1	—
1" I.D.	1-7/8"	1.27"	1.54"	1.125"	3.75"	1-5/16"	1.30"	68578-1	—
1-1/8" I.D.	1-7/8"	1.27"	1.54"	1.5"	3.75"	1-5/16"	1.30"	68579-1	—
1-1/2" I.D.	2-3/8"	1.5"	1.54"	1.5"	4.45"	1-1/2"	1.30"	68581-1	—

Plastic Thru-Hulls & Scupper Valve Fittings

Thru-Hulls

Caution: Plastic Thru-Hull Connectors are designed for installation above the water line only.

Fits Hose Size	Stem Length	Max Hull Thickness	Flange Diameter	Installation Hole Size	Drain Plug	Construction	Color	OEM Part #	Part #
5/8" I.D.	3-1/4"	1-1/4"	1-3/4"	1-1/8"	5/8"	Polypropylene	White	3872-1	3872-3
							Black	3872A1	—
3/4" I.D.	3-1/4"	1-1/4"	1-3/4"	1-1/8"	5/8"	Polypropylene	White	3873-1	3873-3
							Black	3873A1	—
3/4" I.D.	4"	2"	2"	1-1/16" to 1-1/8"	5/8"?	Acetal	White	3896-1	3896-3
1-1/8" to 1-1/4" I.D.	3-1/4"	1-1/4"	2-1/4"	1-3/8"	7/8"	Polypropylene	White	3874-1	3874-3
							Black	3874A1	—
1-1/2" I.D.	3-1/2"	1-1/4"	3"	1-7/8" to 2"	7/8"	Polypropylene	White	3875-1	3875-3
							Black	3875A1	—
2" I.D.	3-1/2"	1-1/4"	3"	1-7/8" to 2"	7/8"	Polypropylene	White	3845-1	—



3872



3874



3875



3875B

Thru-Transom Thru-Hull Connector

For installation through the transom. Ideal for overflow use in livewell installations. Can be used with the 3876 Scupper Valve in self-bailing applications, or as an exhaust port for a bilge pump. Polypropylene construction.

Caution: Plastic Thru-Hull Connectors are designed for installation above the water line only.

Fits Hose Size	Stem Length	Max Hull Thickness	Flange Diameter	Installation Hole Size	Color	OEM Part #	Part #
1-1/2" I.D.	5-1/2"	3-1/8"	2-3/4"	2"	White	3875B1	—

Double Ended Thru-Hull Connector

Double-Ended Thru-Hull provides watertight transition through bulkheads or tanks. 5" overall length. Polypropylene construction.

Caution: Plastic Thru-Hull Connectors are designed for installation above the water line only.

Fits Hose Size	Max Hull Thickness	Installation Hole Size	OEM Part #	Part #
3/4" I.D.	1-1/8"	1-1/8"	3878-1	3878-3



3878

90° Thru-Hull Connectors

90° Thru-Hulls are ideal for tight installations, such as livewell overflow drains. Design eliminates hose kinking. Polypropylene construction.

Caution: Plastic Thru-Hull Connectors are designed for installation above the water line only.

Fits Hose Size	Max Hull Thickness	Flange Diameter	Installation Hole Size	Drain Plug	Color	OEM Part #	Part #
3/4" I.D.	1"	1-1/2"	1"	1/2"	White	3877-1	3877-3
					Black	3880-1	—
1-1/8" to 1-1/4" I.D.	1-7/8"	2-7/16"	1-5/16"	7/8"	White	3879-1	3879-3
					Black	3870-1	—



3877



3879

Scupper Valve

Provides a water exit for boats with self-bailing cockpits. Acetal construction. Accommodates 3875B thru-transom thru-hull connector (screw holes must be drilled for installation.) Diameter: 2-7/8". Use as a replacement valve for 3881 Thru-Transom Scupper. Caution: Plastic Thru-Hull Connectors are designed for installation above the water line only.

OEM Part #	Part #
3876-1	3876-3



3876

Thru-Transom with Scupper

- The rubber flapper opens to drain water out and closes to prevent backwash.
 - Acetal construction.
 - For 1-1/2" I.D. hose.
 - Installation Hole Size: 2"
 - Service Part Kit: Includes outer ring, rubber flapper, four SS screws
- Caution: Plastic Thru-Hull Connectors are designed for installation above the water line only.

Description	Dimensions	Max Hull Thickness	OEM Part #	Part #
Thru-transom with scupper	6-1/4" L x 2-7/8" dia.	3-1/8"	3881-1	—
Service Part Kit			3881Kit-1	—



3881

Thru-Hull with Strainer

Thru-hull connector with strainer prevents clogging of the aerator pump. Strainer attaches to threads that extend beyond external retaining nut. Acetal construction. Caution: Do not use strainer as a thru-hull connector nut replacement.

Hose Size	Max Hull Thickness	Installation Hole Size	OEM Part #	Part #
3/4" I.D.	1-7/16"	1-1/16" to 1-1/8"	3886-1	3886-3



3886

Drains, Drain Plugs & Tubes

Mesh Strainer/Drain Filter

Durable strainers to prevent debris from clogging baitwell drains and aerator pumps. Two types of construction: formed stainless steel wire mesh molded into black PVC plastic base or acetal plastic.

Caution: Aerator pump must be secured with aerator attachment nut prior to installing strainer.

Type	Thread	Application	OEM Part #	Part #
Stainless Steel mesh	7/8"- 9 UNC2-B	Fits 3877-1 thru-hull	11524-1	11524-3
	3/4"-14 NPSM	Fits 3/4" aerator inlet and 3886-1 thru-hull	4232-1	4232-7
Molded plastic	3/4"-14 NPSM	Fits aerator inlet and 3886-1 thru-hull	3885-1	3885-3



11524



3885

Cockpit Drains

For use with 1-1/2" I.D. hose as part of a self-bailing cockpit system. Features short stem and narrow flange for installing through cockpits. Polypropylene construction.

Description	Stem Length	Max Hull Thickness	Flange Diameter	Installation Hole Size	OEM Part #	Part #
Drain	3-3/4"	1-1/2"	2-1/8"	1-7/8"	3875C1	—
Drain with screen	4-3/32"	1-7/32"	2-1/8"	1-7/8"	3882-1	—



Drain Fittings

These drain fittings can be used with a hose connector to create a drain. Use 3888 with 3899 or 3890 threaded/hose-to-barb connector. Use 3889 with 3891 threaded/hose-to-barb connector. Acetal construction.

Description	Dimensions	Max Hull Thickness	Installation Hole Size	OEM Part #	Part #
3/4" diameter	1-1/2"	1-1/8"	1-1/16" to 1-1/8"	3888-1	—
1-1/8" diameter	1-1/2"	1-1/16"	1-7/16" to 1-1/2"	3889-1	—



Drain Cover

Polished stainless steel drain cover can be used for floor drains, vents, or hidden horn openings. Four holes for #6 fasteners.

Description	OEM Part #	Part #
Stainless Steel, 3-1/4" dia.	66308-1	66308-3



Drain Plug and Receiver Kit

Molded black plastic with threaded receiver. Molded retaining strap. Includes attaching screws and elastomeric gasket for a watertight fit.

Description	OEM Part #	Part #
3/4" dia. one piece plug	17209-1	17211-3



Garboard Drain Plugs

Provides bilge drainage when hauling out. Nut removes with wrench or pliers. Machined, tapered pipe threads ensure watertight plug fit. 3/8" neck depth. Three countersunk holes for #8 fasteners.

Description	Construction	OEM Part #	Part #
1/2" NPT drain	Cast bronze	7555-1	7555-3
Replacement plugs, Pair	Brass	9842-1	9842-3
Replacement plugs, 24 Pair	Brass	—	9842PD1
Replacement plugs, 12 Pair (Saltwater Use)	Stainless Steel	—	9844PD2



Stainless Steel Garboard Drain Plugs

Threaded removable plug. Retention system keeps plug from getting lost. Large 7/8" (27mm) hole for servicing stern drives. High polished #316 stainless steel reduces corrosion.

Description	Construction	OEM Part #	Part #
7/8" diameter	Stainless Steel	7557-1	7557-7
7/8" diameter	Stainless Steel with Gasket	7557G1	—



T-Handle Drain Plugs

A clockwise turn of the T-handle expands the plug to lock in place; turn counterclockwise to release.

- For 1" diameter drains.
- Available in brass or stainless steel.

Handle	Chain	Qty	OEM Part #	Part #
Brass	No	1	7526A1	7526A7
Brass	No	100 in battery box display*	—	7526D1
Brass	No	12 in PDQ display carton	7526PD1	7526D2
Brass Plated	No	1	—	11592-3
Stainless Steel	No	1	—	7518A3
Stainless Steel	No	12 in PDQ display carton	7518PD2	7518PD2

*One UPC sheet for use with all 100 units



7526PD2



7526



7518A3

Snap-Handle Drain Plugs

A clockwise turn of the handle tightens the plug in its tube, and the handle flips down to lock.

- For 1" diameter drains.
- Available in brass or stainless steel, with or without chain.

Handle	Chain	Qty	OEM Part #	Part #
Brass	No	1	7524A1	7524A7
Brass	5" chain	1	7524B1	—
Brass	No	75 in battery box display*	—	7524D1
Brass	No	12 in PDQ display carton	7524PD2	7524PD2
Brass Plated	No	1	—	11591-3
Brass Plated	No	24 in PDQ display carton	—	11586-4
Stainless Steel	No	1	7520A1	7520A3
Stainless Steel	No	12 in PDQ display carton	—	7520PD2

*One UPC sheet for use with all 75 units



7524PD2



7524



7520A3

Livewell/Bailer Drain Plugs

Clockwise turn of the handle tightens plug, lever flips down to lock. Ideal for livewell drains.

- Cam-action neoprene plugs snap shut to form stopper for livewells / baitwells.
- Brass snaps and plates.

Note: Not for use with chemicals or fuels.

For use with	Qty	OEM Part #	Part #
7/16" I.D. thru-hull	1	—	7532A3
1/2" I.D. thru-hull	1	7533A1	7533A7
1/2" I.D. thru-hull	12 in PDQ display carton	7533PD2	7533PD2
5/8" I.D. thru-hull	1	7534A1	7534A3



7533PD2



7533

Drain Tubes

- Drain tubes for 1" diameter drain plugs.
- Use aluminum drain tubes with aluminum-handle drain plugs; use brass tubes with brass-handle plugs and stainless steel plug handles.
- Tubes have .032" wall thickness.

Length	OEM Part #	Part #
1-7/8"	7566AR1	—
2-3/8"	7566BG1	—
3"	11446-1	—



7566BG

VENTILATION

Day/Night Solar Vent



38

Day/Night solar vents offer 24-hour ventilation in a compact footprint. The new design can be removed from the deck and features LED lights and additional controls that are accessed from the cabin.

MiniVent 1000



39

The MiniVent 1000 is the smallest and most economical solar vent in the Marincó® line. At just 7" in diameter and approximately 1-3/4" high, the MiniVent 1000 is compact yet effective. This solar powered model is an exhaust vent only.

Air Vent 500 Passive Exhaust Ventilation

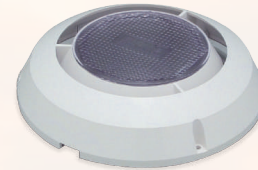

39

Marincó offers the AirVent 500 as a non-solar ventilation option that can passively move 600 to 1,000 cubic feet of air per hour in a 15 knot breeze. Marincó's engineering expertise created this vent to be strong, compact and effective.



VENTILATION

Cowl Vents



40

Cowl Vents are available in both low profile and standard height contours. These vents are a perfect air intake supplement to solar ventilation, and are also commonly used as a bilge ventilating system with or without a mechanical blower.

Clam Shell Vents



41

Clam shell vents are ideal for ventilation needs where a taller vent would foul lines or restrict crew movement. These vents work well as stern mounted ventilators for engine compartments.

In-Line Blowers



42

Attwood in-line blowers provide ventilation for engine compartments, galleys, and bilges. Utilizing advanced fan blade design techniques, Attwood has developed a blower system that matches air flow of existing in-line blowers at a significantly reduced noise level.

Vents & Collector Boxes



44

All collector boxes and vents are designed for intake or exhaust and meet ABYC H-2 requirements.



TECH TIP

Ventilation Explained

Maintenance Ventilation

In most climates, boats that have been closed for a period of time will become “stuffy.” The temperature differential that develops between the boat cabin and the outdoor environment will cause the humidity level inside the boat cabin to rise. When the humidity level in the closed cabin rises, moisture forms, resulting in mold, mildew and musty air. In these conditions, fabrics, boat electronics and even the boat’s fiberglass structure can be damaged. By consistently replacing trapped, stale air in the closed boat with fresh outside air, the humidity equalizes from inside to outside, resulting in effective maintenance ventilation.

Comfort Ventilation

Combining different types of vents, with one vent providing “intake” air flow while another vent provides “exhaust” air flow, creates cross-flow ventilation. A cross-flow ventilation system will make the interior cabin more comfortable and pleasurable because air is constantly moving throughout the cabin. No matter what your boat size or cabin configuration is, you can increase your boating enjoyment with the addition of ventilation.

Safety Ventilation

Most boaters are unaware of the hazards that exist in the boating environment. Any number of serious ventilation problems can occur when a boat is left unattended. And even if you are underway, these problems don’t go away. Fumes and gasses, ranging from carbon

monoxide to hydrogen gas from battery charging, to gasoline, propane or solvents stored below, are unpleasant, and can sometimes be dangerous. Also, any open flame devices in the cabin require proper ventilation. Ventilation helps to eliminate these hazards by providing constant air circulation resulting in effective safety ventilation.

How Much Ventilation Is Required For Your Boat?

Ideally, the air in the interior of a boat should be circulated once every hour. A typical 30-foot boat contains approximately 800 cubic feet of air. As you will see, our solar powered models can move between 600 and 1,000 cubic feet of air every hour. The general guidelines for providing maintenance ventilation are as follows:

Boat Size	Recommended Ventilation
Up to 24’.	1 Exhaust Vent*
24’ to 40’.	1 Exhaust Vent & 1 Intake Vent
40’ and larger	2 Exhaust Vents & 1 Intake Vent

* For effective maintenance ventilation, one vent assumes there will be access for air to get into the cabin (i.e., cowl vent, clamshell vent or louvered panel)

It is important to evaluate the cabin layout of your boat to determine optimal locations for both intake and exhaust ventilation. These illustrations suggest placement for Marinco® solar powered vents and Marinco® passive vents.

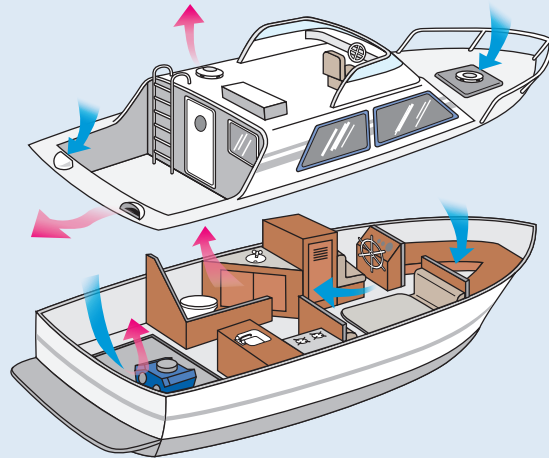
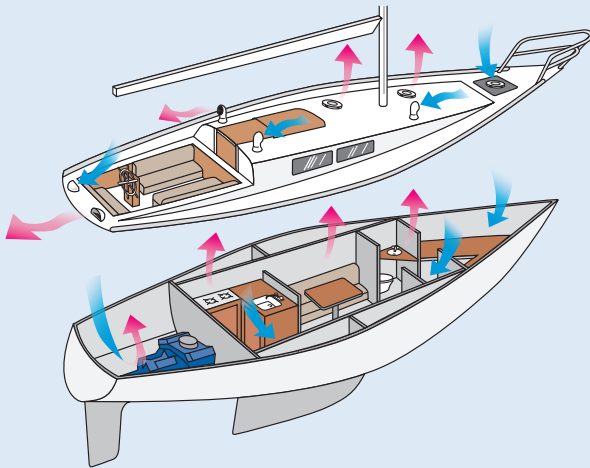

To specifically calculate your boat’s air volume, use this simple formula:

$$A \times B \times C \times 70\% = \text{Boat Interior Volume}$$







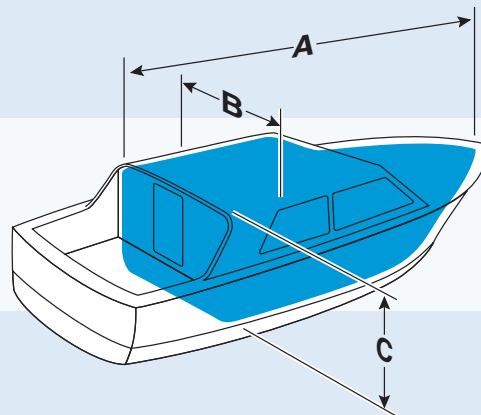



















A Dimension is the interior length (excluding cockpit)

B Dimension is the boat width

C Dimension is the average interior height



Ventilation Selection Chart

Day/Night	Airflow Size	Hole Size Diameter	Deck Plate	Mounting Flange Depth	Operation		Cubic Feet of Air	Intake	Exhaust
					Day	Night			
	4" 102 mm	4-3/4"	Screw-In (6" Outer Diameter)	2.75"	 Solar	 Rechargeable Battery Power	1000 ft ³ /hour 28 m ³ 24,000 ft ³ /day 680 m ³	 Fan (switch)	 Fan
	3" 76 mm	3-3/4"	Screw-In (5" Outer Diameter)	2.75"	 Solar	 Rechargeable Battery Power	800 ft ³ /hour 23 m ³ 19,200 ft ³ /day 550 m ³	 Fan (switch)	 Fan
MiniVent 1000		3" 76 mm	3-3/4"	None (Direct to Deck Mounting)	1"	 Solar	 Passive	700 ft ³ /hour 20 m ³ 5,600 ft ³ /day 160 m ³	Exhaust fan only  Fan
AirVent 500		3" 76 mm	3-3/4"	None (Direct to Deck Mounting)	1"	 Passive	 Passive	600 ft ³ /hour 17 m ³ In a 15 Knot Breeze	 Passive  Passive
Cowl Vents		4" 102 mm	4-3/4"	Snap-In (6" Outer Diameter)	1"	 Passive	 Passive	—	 Passive  Passive
		3" 76 mm	3-3/4"	Snap-In (5" Outer Diameter)	1"	 Passive	 Passive	—	 Passive  Passive

TECH TIP

Vent Installation Explained

Installation

All Marincos® ventilation products include clear, easy-to-understand installation instructions. These instructions address all of the key factors of a professional installation, such as:

- Proper hole measurement and cutting procedures
- Proper deck plate installation
- Use of sealants to waterproof your vent installation
- Installing vents in hatches
- Installing vents in "cambered" or slightly curved decks

Use of interior trim rings to "dress up" the cabin

The high quality level of Marincos Ventilation products must be combined with a sound installation to guarantee that your vent performs in all conditions. Marincos will make sure that your installation will be easy and successful so that you can enjoy the benefits of installation for a long time to come.

Marincos® Ventilation Installation Systems

Snap-In Deck Plate Installation

The 12V vent, 12V combo vent and cowl vents use the Marincos Snap-In deck plate system. The snap-in system allows the easy exchange of any snap-in part for upgrading or convenience, as well as the use of a snap-in cover that completely seals the deck plate making it water tight.

Direct-To-Deck Installation

The Day/Night Plus, MiniVent 1000 and AirVent 500 are designed to be installed directly to the deck without the requirement for a deck plate. All of these vent systems have built-in shut-off dampers that operate from below.

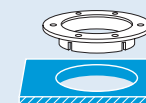
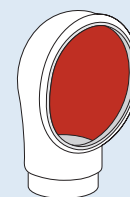

Deck Plate

Deck

Plastic Interior Trim Ring

Day/Night Solar Vent

- Circulates fresh air in boat cabin eliminating mold, mildew and musty air
- Moves 1,000 cubic feet of air/hour or 24,000 cubic feet of air/day (4" model)
- Rechargeable battery allows for 24-hour continuous operation
- No wiring required
- Built-in on/off fan switch, LED lights and intake/exhaust switch
- High capacity NiMh battery operates vent for up to 24-hours without sunlight on a full charge
- Threads into included deck plate and can be removed from outside without tools
- Complete air and green water shut-off from below
- All Day/Night Plus models come complete with white plastic interior trim ring, insect screen, mounting hardware and an easy-to-understand installation manual
- **Replaces NICRO 3" & 4" snap-in deck plates (fits existing holes once snap-in deck plates are removed)**



TRANSITIONING 2024

Description	Marinco Part #	Attwood Part #
3" White	N20803W	N20803W-4
3" Stainless Steel	N20803S	N20803S-4
4" White	N20804W	N20804W-4
4" Stainless Steel	N20804S	N20804S-4

Replacement NiMh Battery

- High capacity battery pack
- 4.8V, 2.5 amp-hours
- Replacement battery pack for current Day/Night Vents



TRANSITIONING 2024

Marinco Part #	Attwood Part #
N20890	N20890-4

Solar Vent Cap

- Includes screw-in watertight cap



TRANSITIONING 2024

Description	Marinco Part #	Attwood Part #
for 3" vents	N20803CAP	N20803CAP-5
for 4" vents	N20804CAP	N20804CAP-5

Replacement Trim Ring



TRANSITIONING 2024

Description	Marinco Part #	Attwood Part #
for 3" vents	N20803RING	N20803CAP-5
for 4" vents	N20804RING	N20804CAP-5

Original Day/Night Plus Vent Accessories

Replacement NiMh Battery

- High capacity C-cell battery
- 1.2V, 2.8 amp-hours
- Replacement battery for older Day/Night Plus Vents, as well as, older model PowerVent 3000 and Day/Night 2000 Vents

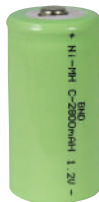

TRANSITIONING 2024

Marinco Part #	Attwood Part #
N20790	N20790-5

TRANSITIONING 2024

Starting Jan 1st 2024, select Marinco items will become Attwood branded. Same great product, but now available through Attwood.

MiniVent 1000

The MiniVent 1000 is the smallest and most economical solar vent in the Marincó® line. At just 7" in diameter and approximately 1-3/4" high, the MiniVent 1000 is compact yet effective. This solar powered model is an exhaust vent only. It will keep the boat cabin cool when you need it most, during the hot sunlight hours. Under solar power, the MiniVent 1000 will move 700 cubic feet of air an hour. At night, even a light breeze will continue to ventilate the boat passively.

Built-in shut-off damper prevents water intrusion in rough seas. Fits a 3-3/4" diameter installation hole. The vent can be retrofitted to an existing hole of up to 6" in diameter. Available in white ABS plastic or stainless steel. Optional stainless steel cover is also available separately.

- Solar powered exhaust ventilation during daylight and passive exhaust at night
- No batteries or wiring required
- Whisper-quiet fan operation
- Durable white ABS construction
- Shut-off damper to prevent water intrusion in rough seas
- Dimensions: 7" diameter X 1-3/4" high
- All MiniVent 1000 models come complete with white plastic interior trim ring, mounting hardware and an easy-to-understand installation manual

TRANSITIONING 2024

Description	Marinco Part #	Attwood Part #
3" White	N20020	N20020-4
3" Stainless Steel	N20030	N20030-4



CE
2 YEAR WARRANTY

Air Vent 500 Passive Exhaust Ventilation

Marinco® offers the AirVent 500 as a non-solar ventilation option that can passively move 600 to 1,000 cubic feet of air per hour in a 15 knot breeze. Marinco's engineering expertise created this vent to be strong, compact and effective. The AirVent 500 is an economical way to provide ventilation in your boat or it can be used in conjunction with other solar powered or 12V vents to create cross flow air circulation.

- Compact size: 7" diameter x 1-3/4" high
- High air flow volume 1,000 cu. ft./hour in a 15 knot breeze
- Strong U.V. stabilized white ABS construction
- Center panel is translucent plastic allowing light to pass through it below deck
- Center damper shuts vent off from below
- Easy installation – attaches directly to deck in compact 3-3/4" diameter hole and can be retrofitted to an existing hole of up to 6" in diameter

TRANSITIONING 2024

Marinco Part #	Attwood Part #
N28810	N28810-5



2 YEAR WARRANTY

TRANSITIONING 2024

Starting Jan 1st 2024, select Marinco items will become Attwood branded. Same great product, but now available through Attwood.

Cowl Vents

Cowl Vents are available in both low profile and standard height contours. These vents are a perfect air intake supplement to solar ventilation, and are also commonly used as a bilge ventilating system with or without a mechanical blower. Marincó® was the first supplier of soft, durable PVC vents that are flexible and safe. For interchangeability, Marincó 4" cowl vent models fit into the same 4" Snap-In deck plates used by the combo and 12V vents (3" or 4" sizes).

- Soft and durable PVC construction returns to original shape if stepped on
- Safer than metal cowl vents – prevents injury and resists snagging lines
- Snap-In vents include deck plate and cover
- 4" models interchangeable with Marincó® Combo and 12V Vent 4" snap-in deck plates
- Marincó adapter accessories make installing below-deck duct hose easy

TRANSITIONING 2024

Starting Jan 1st 2024, select Marincó items will become Attwood branded. Same great product, but now available through Attwood.

Snap-In Deluxe Low Profile PVC Cowl Vent

- White with bright red interior
- Available in 3" or 4" sizes
- 3" size measures 4-1/2" high
- 4" size measures 5-1/2" high
- Includes white Snap-In deck plate and cover

TRANSITIONING 2024

Description	Marincó Part #	Attwood Part #
3"	N10863	N10863-4
4"	N10864	N10864-4



Snap-In Deluxe Standard PVC Cowl Vent

- White with bright red interior
- Available in 3" or 4" sizes
- 3" size measures 8" high
- 4" size measures 10" high
- Includes white Snap-In deck plate and cover

TRANSITIONING 2024

Description	Marincó Part #	Attwood Part #
3"	N10963	N10963-4
4"	N10964	N10964-4



Clam Shell Vents

- Ideal for ventilation needs where a taller vent would foul lines or restrict crew movement
- Work well as stern mounted ventilators for engine compartment
- Can be used for cabin ventilation with dorade boxes
- Flexible PVC construction
- Small clam shell dimensions - Inner : 2-1/2" H x 4-1/2" W x 5" L
Outer: 2-3/4" H x 6" W x 5-1/2" L
- Large clam shell dimensions - Inner : 3" H x 5-3/8" W x 6" L
Outer: 3-1/2" H x 7" W x 6-3/4" L

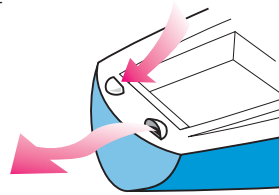

TRANSITIONING 2024

Description	Marinco Part #	Attwood Part #
Small	N10873	N10873-5
Large	N10874	N10874-5

White Snap-In Deck Plate

- Includes Snap-In watertight cover
- Use with any Marinco® Snap-In vent system
- N10863DW requires a 3-3/4" diameter hole cutout
- N10864DW requires a 4-3/4" diameter hole cutout

TRANSITIONING 2024

Description	Marinco Part #	Attwood Part #
3"	N10863DW	N10863DW-5
4"	N10864DW	N10864DW-5



Plastic Interior Trim Ring

- Finishes off interior installation of vent
- Can be installed in decks between 1" and 2" thick
- Available in 3" and 4" sizes
- White plastic construction
- **Note: Interior trim rings are not compatible with threaded deck plates**

TRANSITIONING 2024

Description	Marinco Part #	Attwood Part #
3"	N10866	N10866-5
4"	N10867	N10867-5



Thru Bulkhead Hose Adapter

- For termination attachment of hose to bulkhead
- For attaching hose to cowl vent
- Can be used with Snap-In or threaded deck plates
- For use in decks or bulk heads of more than 1" thick

TRANSITIONING 2024

Description	Marinco Part #	Attwood Part #
3"	N10869	N10869-5
4"	N10870	N10870-5

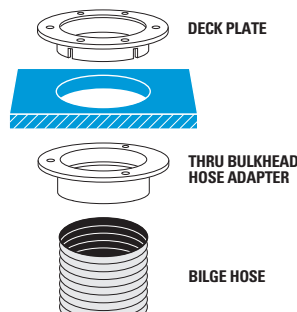

TRANSITIONING 2024

Starting Jan 1st 2024, select Marinco items will become Attwood branded. Same great product, but now available through Attwood.

In-Line Blowers

Attwood offers ventilation equipment and accessories featuring the revolutionary, patented Turbo In-Line Blowers for 3"- and 4"-diameter systems. Turbo blowers are the most dependable, efficient, and powerful in-line blowers on the market, designed using aerospace technology. The Turbo line also features the industry's first water-resistant blower models, with durability proven in rigorous moisture tests and years of success in the field. Attwood offers Turbo water-resistant blowers with an unprecedented three-year limited warranty, and a one-year limited warranty for standard models.

Certifications, Standards and Listings - Blowers

Attwood in-line blowers meet or exceed the following U.S. and international certificates and standards:

- ABYC-H2; ISO 9097
- U.S. Coast Guard Rules, Title 33 CFR sections 183.410, and 183.610 (b)
- Tested to ANSI/AMCA (210-85) and ANSI/ASHRAE (51-1985) standards
- NMMA "As Approved Listing"
- CE
- UKCA
- RCA

Turbo In-Line Blowers

The first vane axial-flow fan bilge blowers designed using aerospace technology to maximize performance. No other bilge blowers in the industry provide such powerful system output at such low power input in a compact size.

- Patented in-line design – provides ventilation for engine compartments, galleys, bilges, and heads
- System airflow exceeds old-style in-line blowers by as much as 25%
- Draws up to 40% fewer amps, making our Turbo blowers up to four times more efficient than competitive blowers
- Marine ignition protected

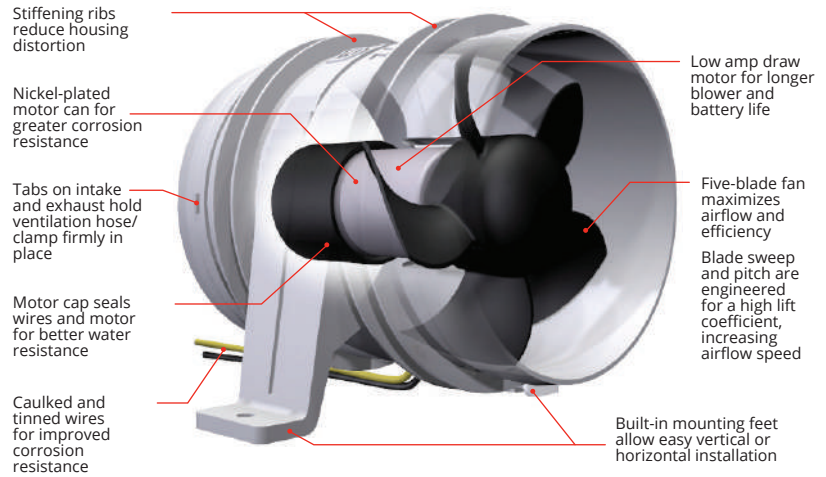

Pump Dimensions

Model No.	A	B	C	D
Turbo 3000	3-5/8"	4-1/2"	5-1/16"	3"
Turbo 4000	4-17/32"	5-1/2"	6-1/16"	4"

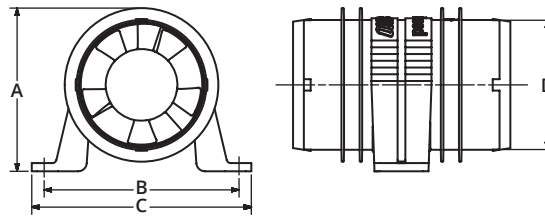

Specifications

Model No.	Rated Voltage	CFM Open Flow	CFM In System*	Current Draw Amps	Fuse Size	Wave Length
Turbo 3000	12V nominal	120	90	2.6	4A	7-1/2"
	13.6V design	145	100	3.1	4A	7-1/2"
Turbo 4000	12V nominal	200	100	2.5	5A	7-1/2"
	13.6V design	230	125	2.9	5A	7-1/2"
	24V nominal	200	100	1.5	3A	7-1/2"
	27.2V design	230	125	2.0	3A	7-1/2"

Note- In system = 3 ft of duct with one 90° bend, a collector box and louvered vent on discharge side of blower at 13.6V DC

Turbo 3000 Series

For 3" I.D. ventilation hose. Install with #10 fasteners. Individual carton includes 2 tie straps.

Model No.	Description	OEM Part #	Part #
Turbo 3000	Water-resistant, 12V, White, 3-year Warranty	1733-1	1733-4



1733

Turbo 4000 Series II

Our 4000 Series II blower system matches air flow of existing in-line blowers at a significantly reduced noise level. For added durability, Attwood incorporates an engineered plastic housing that resists deformation during installation and prevents blade to housing interference.

For 4" I.D. ventilation hose. Install with #10 fasteners. Individual carton includes two tie straps.

Model No.	Description	OEM Part #	Part #
Turbo 4000	Water-resistant, 12V, White, 3-year Warranty	1749-1	1749-4
	Water-resistant, 24V, White, 3-year Warranty	1751-1	—



1749



Vents & Collector Boxes

Attwood hull-mounted vents are designed to install by fastening as a complete unit from either inside or outside the hull. Ventilation hose (not included) twists into the bottom of the box to form a raised water barrier. Plastic vents are corrosion-resistant and will not discolor. All collector boxes and vents are designed for intake or exhaust and meet ABYC H-2 cross sectional area requirements.



Stainless Steel Louvered Vent

- All-welded #304 Stainless Steel construction with polished finish.
- Install with #8 fasteners.
- Requires collector box 1487A for 3" system.

For use with Collector Box(es)	Installation Hole Size	OEM Part #	Part #
1487A1	3-1/4" x 10-3/8"	1488-1	1488-5

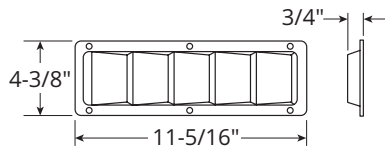

Collector Boxes

- Collector boxes for use with 1488 stainless steel vent.
- Available with cut-out for two 3" I.D. wire-supported hoses or one 4" I.D. wire-supported hose.
- Corrosion-resistant plastic.

For Use with Vent(s)	Depth	Installation Hole Size	OEM Part #	Part #
1488	5-9/16"	3-5/8" x 10-3/4"	1487A1	—



1493



1499



Narrow Stainless Steel Louvered Vents

- Suitable for installation on any flat or most contoured hulls.
- Constructed of all-welded #304 Stainless Steel with a polished finish.
- Vents for use with 3" I.D. ventilation systems, and require a 1343 collector box.
- Install with #6 fasteners.

For use with Collector Box	Installation Hole Size	A Depth	OEM Part #	Part #
1343	2-1/16" x 15-15/16"	9/16"	1493-1	1493-5
		1/16"	1499-1	1499-5

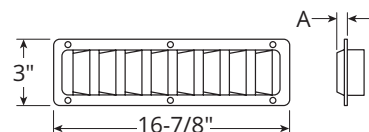

Collector Box

- For use with narrow stainless steel vents (1493 or 1499), with two 3" I.D. wire-supported ventilation hoses.
- Corrosion-resistant plastic.

For Use with Vent(s)	Depth	Installation Hole Size	OEM Part #	Part #
1493, 1499	4-1/16"	2-7/16" x 16-3/16"	1343-1	—

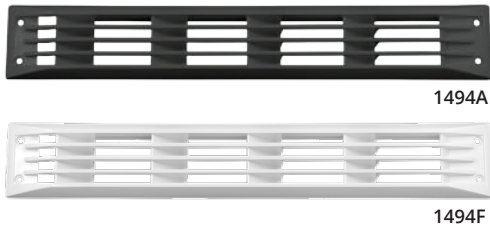

Venturi Vents

Clean, contemporary, louver design. Sized for installation even on highly-contoured decks.

- For 3" or 4" I.D. ventilation system.
- Corrosion-resistant, paintable ABS plastic.
- Requires 1341 collector box for 3" system, or 1342 for 4" system.
- Install with #8 fasteners

For use with Collector Box	Installation Hole Size	Color	OEM Part #	Part #
1341, 1342	2" x 15-3/8"	Black	1494A1	1494A5
		White	1494F1	—

Flush Louvered Vents

Canted louvers deflect rain and spray and help conceal the collector box. Installs flush to hull. Drain slots to prevent water accumulation.

- Black vent is ABS plastic, white vent is ASA plastic. Both are paintable.
- Requires 1341 collector box for 3" system, or 1342 for 4" system.
- Install with #8 fasteners.

For use with Collector Box	Installation Hole Size	Color	OEM Part #	Part #
1341, 1342	2" x 15-1/4"	Black	1423-1	1423-5
		White	1425-1	1425-5

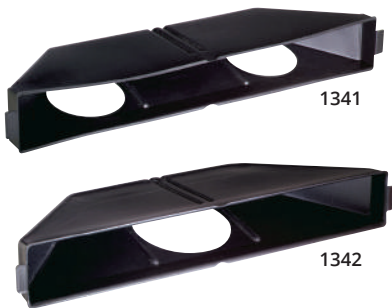
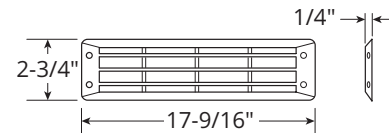
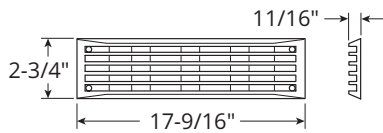

Collector Boxes

For use with Venturi, Flush Louvered or Trimline Vents.

- Corrosion-resistant plastic.

For Use with Vent(s)	Hoses	Installation Hole Size	Depth	OEM Part #	Part #
1494, 1423, 1425, 1426	For two 3" I.D. hoses	2-1/16" x 15-9/16"	3-7/8"	1341-1	—
1494, 1423	For one 4" I.D. hose	2-1/8" x 15-5/8"	5"	1342-1	—



1495B

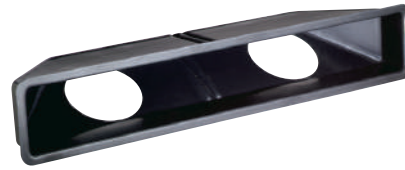

Plastic Louvered Vents

- Constructed of paintable, corrosion-resistant ABS plastic with no sharp edges.
- For 3" I.D. ventilation system with 1345 collector box.
- Install with #8 fasteners.

For use with Collector Box	Installation Hole Size	Color	OEM Part #	Part #
		Chrome Plated	1495B1	1495B5
1345	2-1/4" x 16"	Black	1495A1	—
		Off-White	1495-1	—

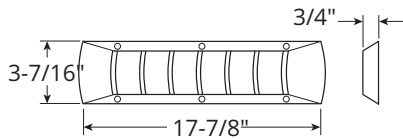

Collector Box

- For use with plastic louvered vent, with two 3" I.D. wire-supported ventilation hoses.
- Box fastens to vent with screws or pop rivets, then vent fastens to the deck.
- Corrosion-resistant plastic.

For Use with Vent(s)	Depth	Installation Hole Size	OEM Part #	Part #
1495	4"	2-7/16" x 16-1/4"	1345-1	—



1438

Modular Vents

Modular construction to accommodate any ventilation opening size by interlocking two or more center sections. End sections interlock to the center section for a finished appearance.

- For 4" I.D. ventilation systems
- End sections have two holes for #8 fasteners.

For Use with Collector Box	Section	Color	Installation Hole Size	OEM Part #	Part #
1348 (one or multiple)	Center	White	2-1/2" x 17-3/4"	1438F1	—
	Ends	White	2-1/2" x 17-3/4"	1439F1	—

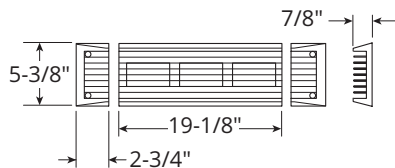

Collector Box

For use with modular vents, with 4" I.D. wire-supported ventilation hose.

- For two 4" I.D. hoses
- Corrosion-resistant plastic.
- Installation Hole Size: 2-3/4" x 18"

For Use with Vent(s)	Depth	OEM Part #	Part #
1438, 1439	5"	1348-1	—





Cowl Ventilator

- For use with 3" I.D. wire-supported ventilation hose.
- Flexible hose flange is screwed onto hose, then vent snaps onto the flange. Flange is non-corrosive plastic.
- Vent constructed of chrome-plated zinc.
- Installs with #8 fasteners.
- Dimensions: 5-5/16" W x 6" L x 2-1/4" H (neck extends 1" below deck)

Installation Hole Size	OEM Part #	Part #
3-1/4" x 3-12"	1364A1	1364A3



Twist-On Hose Flange

- For use with 3" I.D. wire-supported ventilation hose.
- Hose installs from topside by turning the flange into the hose spiral, passing the hose through the deck hole, then mounting ventilator. No hose clamps needed.
- Corrosion-resistant plastic.
- Four holes for required #10 fasteners.

Color	Installation Hole Size	OEM Part #	Part #
Black	3.5"	1405-1	1405-3



Storage Vent

Use to vent lockers and storage areas. Provides over six square inches of ventilation opening.

- Will not accept a ventilation hose.
- Corrosion-resistant plastic.
- Two holes for required #6 fasteners.

Height	Neck	Flange Dia.	Installation Hole Size	Color	OEM Part #	Part #
1-1/16"	5/8"	3-3/16"	3-1/16" to 3-1/8"	Black	1353-1	—



66400

Clamshell Vent

Provides a seal and splash protection for vent holes, wire and hose openings.

- Sizes to fit most common applications.
- Durable 300 series stainless steel construction.
- Three holes for required #6 fasteners.

Vent Width	Size	Max Hole Size	Hose/Wire Max Size	OEM Part #	Part #
1-3/16"	1-9/16" L x 1/2" H	1"	7/16"	66399-1	66399-3
2-3/16"	2-1/4" L x 9/16" H	1-1/2"	9/16"	66400-1	66400-3

LIGHTING

Sidelights



54

Attwood Sidelights are designed with top quality materials, providing efficient light output, style, and durability.

PowerBase Series

NEW



68

The intelligent, automated folding light & antenna. Easily stows and deploys lights and antennas with the push of a button.

All-Round Lights & Bases



62

Attwood offers a wide selection of durable, stowaway, pole-mounted lights. Choose the style of light head, lens and pole to fit a base suited to your installation location.

Anchor/Masthead Lights



73

Innovative, robust, and easy to use, our anchor/masthead lights are designed to achieve 360* visibility, while drawing a fraction of the power of traditional incandescent lights.

Transom Lights



72

For pleasure craft up to 20m (65.6 ft.) in length, transom lights provide reliability and efficiency to illuminate the waters below.

LIGHTING

Precision Wireless Controlled Spotlight



74

Controlled by wireless remote control. Provides 370° sweep and 120° tilt. Designed for harsh marine environments, it is moisture, salt, and vibration resistant.

IP67 Stainless Steel Spot/Floodlight



75

Features a 7", 12 LED array, and IP67 stainless construction. Creates approx. three times concentrated spot diameter while drawing roughly half the power of comparable halogen spotlights. Wireless communication using mounted bridge or hand held remote.

LED Lights



77

Proven LED Solutions for Portable Navigation and Docking, Underwater, and Utility applications.

Light Accessories

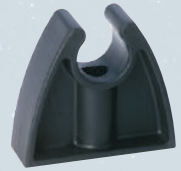

83

Protect your lights with Attwood's replacement parts that are easy to install and maintain.



Navigation Overview

Lighting the Way – Types of Navigation Lights

This section is divided into four basic types of navigation lights, differentiated by lens color, beam angle (horizontal cut-off angle), and location on the boat. All lights are for 12V DC applications only. Styles may vary, but the color, cut-off angle, and location must always comply with the following standards:

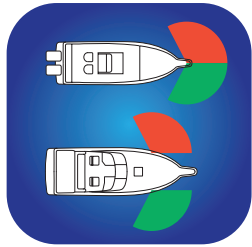

Sidelights

For boats under power up to 20m (65.6ft).

Light Color: Red (port) and/or Green (starboard)

Cut-off: From dead ahead to 112.5° aft on either side of center line (225° total horiz. arc).

Mounting: As far fore as possible

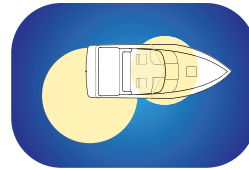

All-Round Lights

For boats less than 12 m (39.4 ft.). The white all-round light may be used in lieu of a masthead or transom light.

Light Color: White

Cut-off: Unbroken arc of 360° on the horizon.

Mounting: As near to the fore and aft centerline as possible

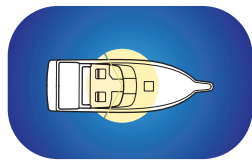

Anchor/Masthead Lights

For boats under power up to 20m (65.6ft).

Light Color: White

Cut-off: Unbroken arc from dead ahead to 112.5° aft on either side of center line (225° total horizontal arc), plus 135° dead astern

Mounting: Placed over the fore and aft centerline

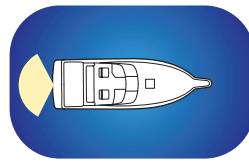

Transom Lights

For boats under power up to 20m (65.6ft).

Light Color: White

Cut-off: Unbroken horizontal arc of 67.5° each side dead astern (135° total horizontal arc).

Mounting: As far aft as possible

Vertical Separation of Lights

Pole length and location determines light separation. On boats under 12 m (39.4 ft.), the all-round or masthead light must be located a minimum of one meter (39-3/8") above the red-green sidelights. One meter must be the height separation measured from bulb filament centers.

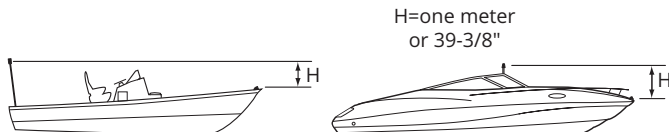

On boats of 12 to 20 m (39.4 to 65.6 ft), the masthead light must be at least 2.5 m (8.2 ft) above the gunwale.

2.5 meters
or 8.2 feet

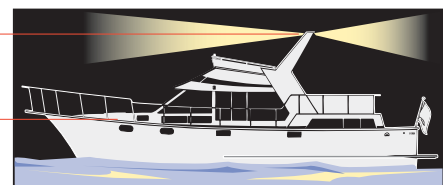

Boats at Anchor

When anchored in other than designated areas, any boat under 50 m (164 ft.) must have a 360° white light in view (a single all-round light, a masthead and transom light, or other means).

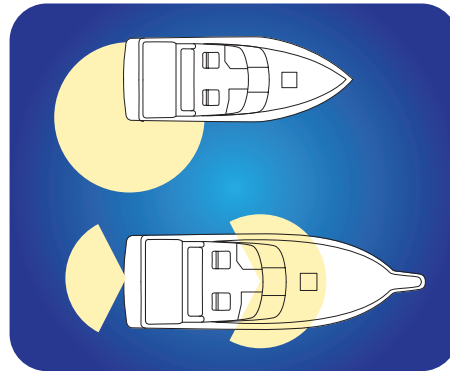

Boats Underway

This section outlines the navigation lighting required according to current U.S. Coast Guard and 72 COLREGS (International Waters) regulations. When underway, the required navigation lights are:

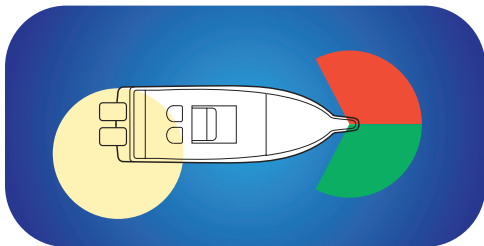

Power-driven boats less than 12 m (39.4 ft.) with max. speed over 7 knots:

- Sidelight pair or combined—1 mile
- All-Round Light—2 mile or Masthead Light—2 mile with Transom Light—2 mile.

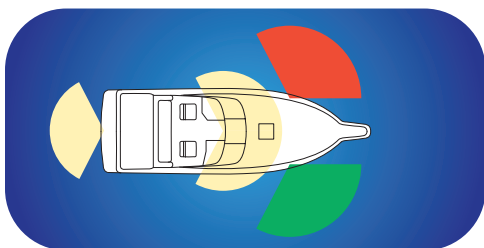

Power-driven boats 12 to 20 m (39.4 to 65.6 ft.):

- Sidelight pair or combined—2 mile
- Masthead Light—3 mile and Transom Light—2 mile.
- All-Round Light may not be used.

Small, Oar-Driven Boats:

- Sidelight pair or combined—1 mile
- Transom Light—2 mile
- Flashlight or lighted lantern.
- Various other light requirements are outlined in the standards regarding towing, vessels aground, and other special conditions
- Consult the Inland Navigation Rules, 72 COLREGS, or USCG for details.

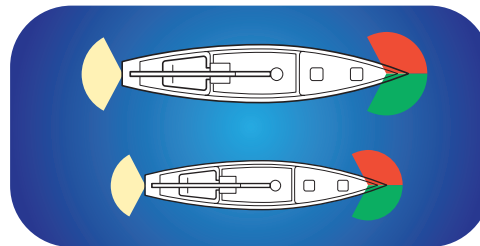

Sailboats less than 7 m (23 ft.) under sail:

- Sidelight pair or combined—1 mile
- Transom Light—2 mile
- Flashlight or lighted lantern.

Sailboats Under Motor Power:

When under power, sailboats are considered power boats and must operate with power boat lights as previously outlined.

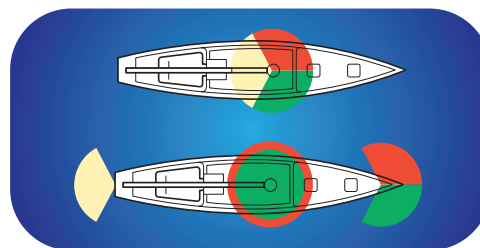

Sailboats 7 to 20 m (23 to 65.6 ft.) under sail:

Three different light configurations may be acceptable:

1. Sidelights & Transom Light.
2. A Sidelight & Transom Light combined in one light (a Tri-Color Light) mounted at or near top of mast.
3. Sidelights & Transom Light, or two All-Round Lights, mounted at or near the top of the mast, the upper light being red and the lower green.

Why Attwood LED?

A New Level of Efficiency

Through the use of proprietary optical design techniques, we've optimized our lens design to harness nearly 90% of all light being generated by the LED. In doing so, our line of LED series navigational lights exceed U.S. Coast Guard requirements with the fewest and lowest watt LEDs of any navigational light manufactured today. Less energy used by navigational lighting means more energy available for powering your boat and enjoying time on the water.

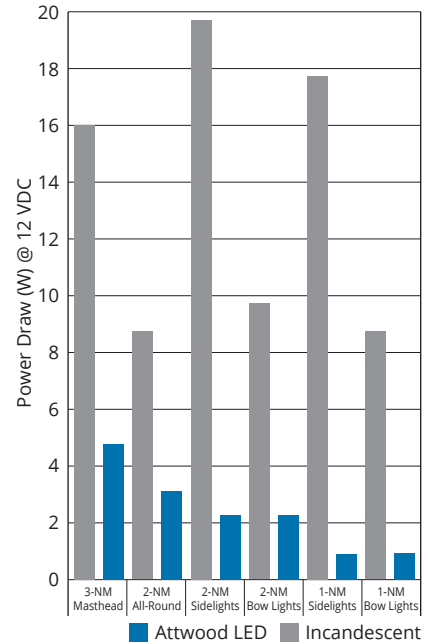
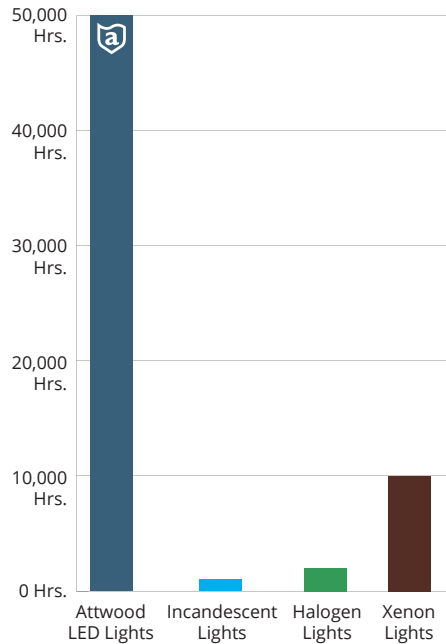

Engineered to Last

As the emerging leader in marine lighting design, Attwood understands the demands of the marine environment. Completely sealed LED units resist water intrusion, electrostatic discharge (during assembly), vibration and ultraviolet light (UV) radiation. Reverse polarity protection has been added to eliminate potential mis-wiring damage during installation. Our LED navigational lighting also features high-quality, electro-polished stainless steel covers designed to resist corrosion in even the most extreme saltwater environments. The result? Style and durability. Most importantly, Attwood lights are built to stand the test of time. Rated for 50,000+ hours of use, you can count on Attwood products to light your way for years to come.

LED Light Engine

Positioned and sealed inside a lens assembly, the "light engine" serves as the equivalent of an LED (Light Emitting Diode). It can be easily customized to meet the needs of a builder in terms of attachment scheme and overall dimensions.



Ready for the Global Market

- EN/ISO 19009:2015
- ABYC A-16 & C-5
- 1972 COLREGS
- RCD 2013/53/EU
- USG 33 CFR

Choice of Electrical Connectors

Attwood lights feature several wire attachment styles to adapt to your boat's wiring harness. Standard wire on all lights are tinned and caulked.

Special connectors are available on special order by contacting your Attwood representative. Minimum order quantity may vary by part.

Brown – Positive, Black – Negative, Brown & White – Manual Override



Standard



2-Way Molded (MP1)



Packard Connector



Packard Connector, Water-Resistant



Amp Connector



Amp Connector, Water-Resistant



Quick Silver Connector



Duetsch Connector



Delphi Connector

Certifications, Codes, and Standards

This section provides you with some general information on the selection and installation of navigation lights for pleasure boats of 20 m (65.6 ft.) or less. For details refer to: ABYC C-5, ABYC A-16, 72 COLREGS, Inland Navigation Rules, U.S. Code of Federal Regulations Title 33 Part 1P, or international regulations. The following Attwood navigation lights are NMMA listed and meet 72 COLREGS as noted.



This symbol indicates Attwood navigation lighting products that have been certified according to the latest U.S. Coast Guard regulations.

Nav Light Type	Series	Visibility	OEM Status	NMMA Type Acceptance Number	Meets COLREGS 1972	Meets ABYC A-16/C-5	Meets ISO 19009:2015
	2500 Series Horn	—	Active	2515284	—	—	—
BiColor Sidelight	NV1002	2NM	Active	2619456	Yes	Yes	Yes
	NV2002	2NM	Active	2619457	Yes	Yes	Yes
	NV6LC	2NM	Active	2619458	Yes	Yes	Yes
	NV6SP	2NM	Active	2619459	Yes	Yes	Yes
Sidelight Pairs	NV1012	2NM	Active	2619450	Yes	Yes	Yes
	NV2012	2NM	Active	2619449	Yes	Yes	Yes
	NV3012	2NM	Active	2619453	Yes	Yes	Yes
	NV4012	2NM	Active	2619454	Yes	Yes	Yes
	NV5012	2NM	Active	2619455	Yes	Yes	Yes
	NV0002P	2NM	Active	2619536	Yes	Yes	Yes
	NV0002S	2NM	Active	2619536	Yes	Yes	Yes
All-Round	5530	2NM	Active	2619411	Yes	Yes	Yes
	5540	2NM	Active	2619411	Yes	Yes	Yes
	5550	2NM	Active	2619411	Yes	Yes	Yes
	5560	2NM	Active	2619411	Yes	Yes	Yes
	5570	2NM	Active	2619411	Yes	Yes	Yes
	5580	2NM	Active	2619411	Yes	Yes	Yes
	5590	2NM	Active	2619411	Yes	Yes	Yes
Transom	6556	3NM	Active	2619513	Yes	Yes	Yes
Masthead	7800	3NM	Active	2469859	Yes	Yes	Yes

Deck Mounted Sidelights

LIGHTARMOR™

LED Navigation Lights: 2-Mile

LightArmor Navigation Lights have all the characteristics that signifies the premium LightArmor brand: top-quality materials, robust construction, durability, and sleek design

- Meets standards ABYC C-5 & A-16, USCG CFR 183.81
- Proprietary modular LED light engine technology
- Design flexibility and ease of installation

Deck Mount Lights

2-Mile Lights For use on boats up to 65.6 ft (20 m) in length.



Description	OEM Part #	Part #
Stainless Steel		
2-NM, Oval, Bi-Color	NV1002SS-1	—
2-NM, Oval, Red/Green, Pair Sidelights	NV1012SS-1	—
2-NM, Round, Bi-Color	NV2002SS-1	NV2002SS-7
2-NM, Round, Red/Green, Pair Sidelights	NV2012SS-1	NV2012SSR-7† / NV2012SSG-7†
Black Composite		
2-NM, Oval, Bi-Color	NV1002PB-1	—
2-NM, Oval, Red/Green, Pair Sidelights	NV1012PB-1	—
2-NM, Round, Bi-Color	NV2002PB-1	NV2002PB-7
2-NM, Round, Red/Green, Pair Sidelights	NV2012PB-1	NV2012PBG-7† / NV2012PBR-7†

Oval Shape



NV1012SS



NV1002SS

NV1002PB

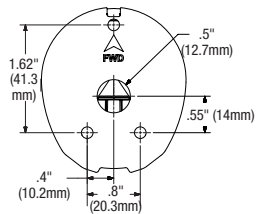
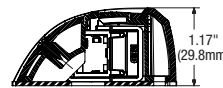

Round Shape



NV2012PB

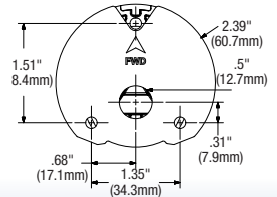
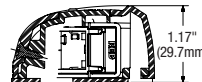

† Red/Green Sidelights packaged separately for aftermarket.



Vertical Mount Lights

2-Mile Lights For use on boats up to 65.6 ft (20 m) in length.

Description	OEM Part #	Part #
Stainless Steel		
2-NM, Round, Red/Green Pair	NV3012SS-1	NV3012SSG-7 [†] / NV3012SSR-7 [†]
2-NM, Elliptical, Red/Green Pair	NV4012SS-1	NV4012SSG-7 [†] / NV4012SSR-7 [†]
2-NM, Oval, Red/Green Pair	NV5012SS-1	—
Black Composite		
2-NM, Oval, Red/Green Pair	NV5012PB-1	—

Round Shape



NV3012SS

Elliptical Shape



NV4012SS

Oval Shape



NV5012PB

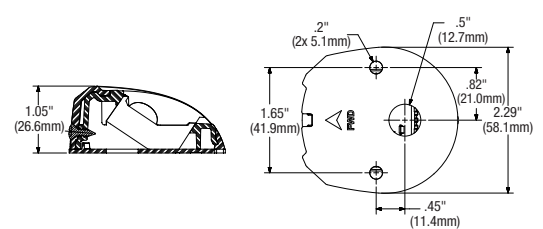
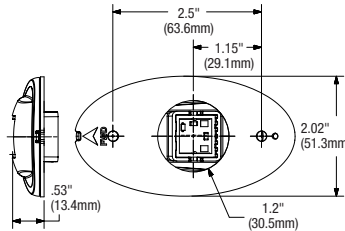
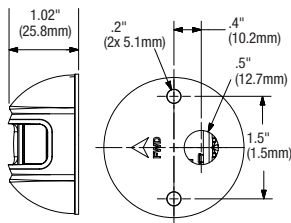

Modular Lights

- LIGHTARMOR LED Navigation Lights feature an innovative modular LED light engine (lens+composite component) that gives boat manufacturers customization opportunities and freedom to install navigation lights virtually anywhere on the boat (hard tops, custom housings, etc.)
- Colored filter caps provide easier installation and lowers the probability of costly rework.

2-Mile Lights For use on boats up to 65.6 ft (20 m) in length.

Description	OEM Part #
2-NM, Green/Starboard Modular Sidelight	NV0002S-1
2-NM, Red/Port Modular Sidelight	NV0002P-1



NV0002S-1

NV0002P-1

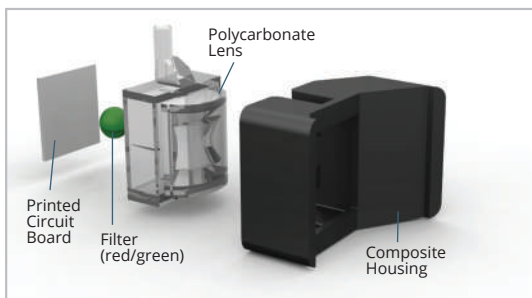

[†] Red/Green Sidelights packaged separately for aftermarket.

FULSAR 5040 Series 1-Mile Sidelights

Bayonet lock design secures lens and cover to base. Includes a 9W (#906) wedge base lamp and 7" wire leads for connection to 12V DC power supply. Installs directly to deck with two #10 fasteners. Cover and lens conceal installation fasteners and seal water out of lamp and hull. For use on boats up to 39.4 ft. (12 m). 1-mile, 225° light visibility.

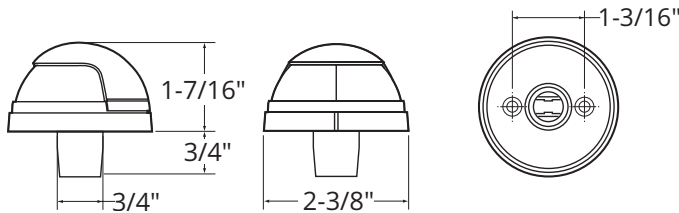
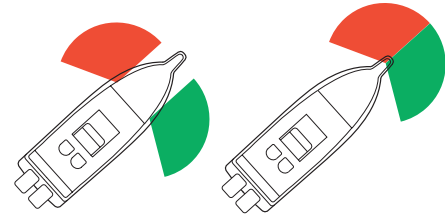

Bi-Color Combination, Deck Mount

Description	OEM Part #	Part #
Black	—	5045-7



Red/Green Pair, Deck Mount

Each light provides 1-mile, 112.5° light visibility. Includes a 9W (#906) wedge base lamp.

Description	OEM Part #	Part #
Black	—	5040R7 [†] / 5040G7 [†]



Red/Green Pair, Raised Base

Ideal for use where light must be elevated for visibility above rails and carpeting. Each light provides 1-mile, 112.5° light visibility. For use on boats up to 39.4 ft. (12 m). Includes a 9W (#906) wedge base lamp.

Description	OEM Part #	Part #
Black	—	5080R7 [†] / 5080G7 [†]

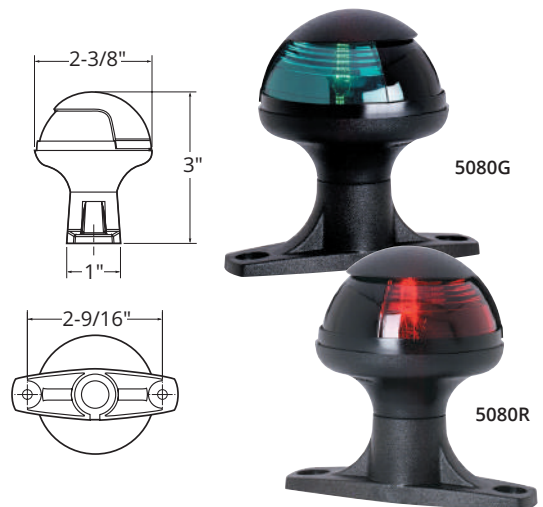

[†] Red/Green Sidelights packaged separately for aftermarket.

Stainless Steel 66000 Series 1-Mile Sidelights

Constructed of corrosion-resistant 304 stainless steel, these lights provide 1-mile visibility for power boats up to 39.4 ft. (12 m). Lights include rubber gasket lens seal for enhanced internal corrosion resistance. Includes one 7.5W lamp. For connection to 12V DC power supply.

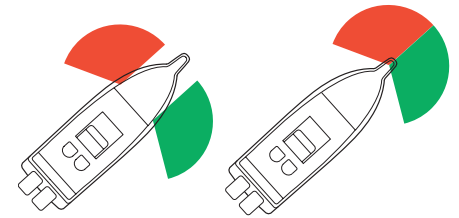
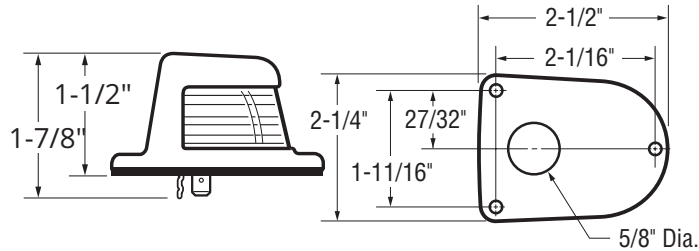

Red/Green Pair, Deck Mount

Installs with three #6 mounting fasteners (not included). Each light provides 1-mile, 112.5° light visibility.

Description	Socket	OEM Part #	Part #
Stainless Steel	7" wire lead	—	66319R7† / 66319G7†



Bi-Color Combination, Deck Mount

Installs with three #6 mounting fasteners (not included). Provides 1-mile, 225° light visibility.

Description	OEM Part #	Part #
Stainless Steel	—	66318-7

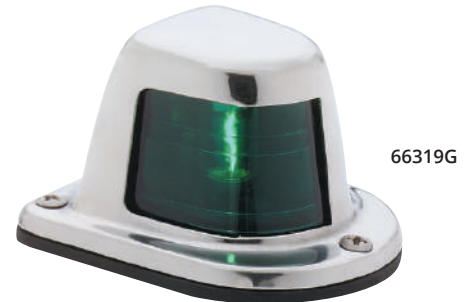

Zamak 6300 Series 1-Mile Sidelights

These die-cast ZAMAK sidelights with Perma-Plate® finish provide 1-mile visibility for power boats up to 39.4 ft. (12 m). Mounts on decks or gunwales with external screws. Includes 7.5W lamp and 7" hard wire leads for 12V DC electrical connection.

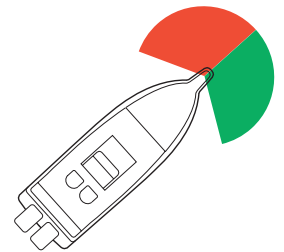

Bi-Color Combination, Deck Mount

Housing completely encases socket. Installs with two #8 fasteners (not included). Provides 1-mile, 225° light visibility.

Description	OEM Part #	Part #
Chrome-Plated ZAMAK	—	6375D6



† Red/Green Sidelights packaged separately for aftermarket.

Pole-Mounted Plug-In Sidelights

LIGHTARMOR™ LED Bi-Color Navigation Pole Lights

LightArmor Stowaway Pole Lights have all the characteristics that signifies the premium LightArmor brand: top-quality materials, robust construction, durability, and sleek design. Available with task light option.

- Meets today's global regulatory requirements, including EN/ISO 19009:2015
- Meets standards ABYC C-5 & A-16, USCG CFR 183.810
- Proprietary modular LED light engine technology
- 2-mile visibility
- Design flexibility and ease of installation

NOTE: locking collar design is compatible only with LightArmor Plug-In Bases

Bi-Color Pole Lights

Series	Use with Light Base
NV6LC1, NV6SP1	910R2, 901V2, 910T2, 2520‡, 911339‡, 911370‡,

Bi-Color Pole Lights with Task Light

Series	Use with Light Base
NV6LC2, NV6SP2	910R3, 901V3, 910T3, 2530‡

‡When locking collar is removed.

Description	Pole Length	OEM Part #	Part #
2-Pin, Locking Collar Pole	10" Straight	NV6LC1-10-1	—
	10" Straight	NV6LC1-10B1*	—
	12" Straight	NV6LC1-12-1	—
	14" Straight	NV6LC1-14-1	NV6LC1-14-7
	16" Straight	NV6LC1-16-1	—
	20" Straight	NV6LC1-20-1	—
	10" Angled	—	NV6LC1-10A7
2-Pin, Standard Pole	10" Straight	NV6SP1-10-1	—
	12" Straight	NV6SP1-12-1	—
	14" Straight	NV6SP1-14-1	—
	16" Straight	NV6SP1-16-1	—
	20" Straight	NV6SP1-20-1	—
	12" Angled	NV6SP1-12A1	—
	14" Angled	NV6SP1-14A1	—
3-Pin, Locking with Task	10" Straight	NV6LC2-10-1	NV6LC2-10-7
	14" Straight	NV6LC2-14-1	NV6LC2-14-7
3-Pin, Standard with Task	10" Straight	NV6SP2-10-1	—
	14" Straight	NV6SP2-14-1	—

*Black Aluminum version

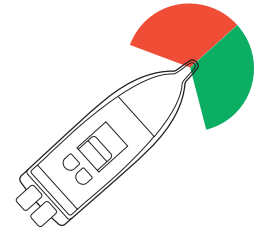

LIGHTARMOR™
Plug-In Bases
See pages 65-67



LIGHTARMOR™ LED Bi-Color Fast Action Navigation Lights

Premium LED lights with a flexible, impact-resistant composite pole make these perfect for anglers and hunters to maneuver through low-hanging obstacles. The subtle, glare-free black matte finish complements many of today's boat designs.

- ISO 19009:2015 Certified
- Impact-resistant polycarbonate lens
- Water resistant
- Corrosion/UV resistant
- LED light engines last for 50,000 hours
- 5-year warranty

Description	Pole Length	OEM Part #	Part #
2-Pin, Locking Collar Pole	10"	NV6LC1-10BP1	—
	12"	NV6LC1-12BP1	—
	14"	NV6LC1-14BP1	NV6LC1-14BP7
	16"	NV6LC1-16BP1	—
2-Pin, Standard Pole	12"	NV6SP1-12BP1	—
3-Pin, Locking Collar Pole	14"	NV6LC2-14BP1	NV6LC2-14BP7



NV6LC1

NV6LC2

PULSAR 5090 Series 1-Mile Sidelights

Attwood offers a variety of durable, stowaway, combination pole-mounted sidelights for bow mounting. Each features an anodized aluminum pole that raises the light head for visibility above trolling motors, anchors, or other equipment on the bow. When not in use, lights can be removed from base and stowed, so they won't interfere with fishing or anchoring.

Incandescent Bi-Color Stowaway

1-mile, 225° light visibility for boats up to 39.4 ft. (12 m). Includes 9W wedge base lamp.

Series	Use with Light Base
5091, 5092	910R2, 901V2, 910T2, 2520‡, 911339‡, 911370‡

‡When locking collar is removed.

Description	Pole Length	OEM Part #	Part #
2-Pin Locking-Collar Pole	10" Straight	—	5092-10-7
	14" Straight	—	5092-14-7
2-Pin Standard Pole	10" Angled	—	5091-10-7
	14" Angled	—	5091-14-7

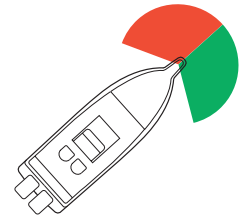

Incandescent Bi-Color Stowaway with Task Light

Based on the same great design of the original Pulsar™ Bi-Color Pole Light, the Task Light also gives you a narrow beam work light. It features a durable rubber “push-on” switch and a micro bulb. Attwood’s Task Light output is ten times brighter than competitive models, giving today’s fishermen the tools they need for serious nighttime fishing.

Series	Use with Light Base
5095	910R3, 901V3, 910T3, 2530‡

‡When locking collar is removed.

Description	Pole Length	OEM Part #	Part #
3-Pin Locking-Collar Pole	10" Straight	—	5095-10-7



2500 Series Horn & Light Base

Ideal solution for today's fishing boat market. Combining both horn and light base components into one integrated module, Attwood's assembly is compact, robust, and easy to install. The acoustic technology provides a louder, more effective, and higher quality sounding product than current industry offerings. Attwood's patent pending water management system efficiently controls water inrush and eliminates the need for a sound reducing cloth at the horn mouth.

Exceptional Sound Quality

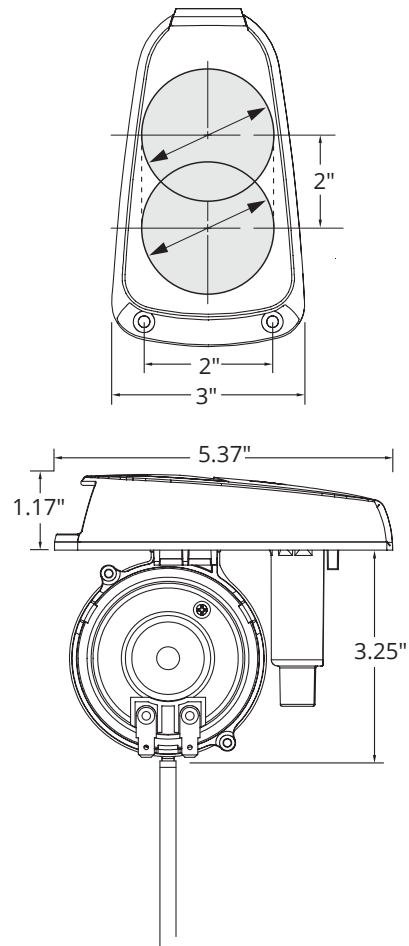
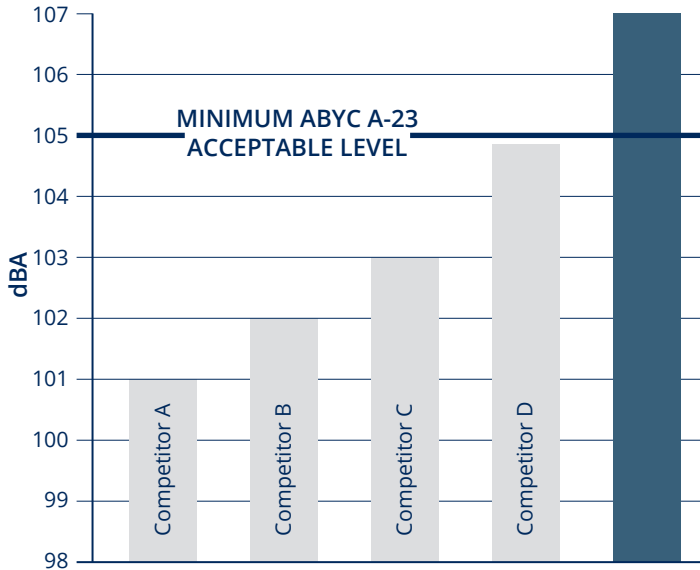

Durable

- Stainless mesh won't tear or puncture like cloth fabric.
- Water management system prevents common horn failures.
- Rubber base cover is flexible to avoid damage if kicked or stepped on.
- Withstands 2500 lb. standing load.
- Horn uses a make/break disc diaphragm to produce a quality tone (The main competitor uses a piezoelectric horn to produce a buzzer sound).

2500 Series Horn & Light Base with Suggested Attwood Pole Lights

Description	Pole Length	OEM Part #	Part #
Horn & Light Base			
2-Wire	—	2520-1	—
3-Wire	—	2530-1	—
Suggested Attwood Pole Lights			
2-Pin, Standard Pole	10" Straight	NV6SP1-10-1	—
	12" Straight	NV6SP1-12-1	—
	14" Straight	NV6SP1-14-1	—
	16" Straight	NV6SP1-16-1	—
	20" Straight	NV6SP1-20-1	—
3-Pin, Standard with Task	10" Straight	NV6SP2-10-1	—
	14" Straight	NV6SP2-14-1	—



Shown with **LIGHTARMOR** LED Bi-color Pole Light

All-Round Plug-In Lights Overview

Attwood offers a selection of durable, stowaway, pole-mounted lights. Plug-in pole lights are available in socket styles to fit most Attwood's 2- and 3-pin bases, and competitive brands of bases when the 2- or 3-pin locking-collar pole is specified.

Pole Light Selection

Simply choose the style of light head and lens you need and select the pole style to fit your existing base. Or select a matching base best suited to your installation location. Black pole option available upon request.



Locking-Collar Pole with Universal Fit

Locking-collar poles offer universal fit allowing customers to use them with a wide variety of Attwood 2- and 3-pin straight or angled bases. They also work as replacements in competitive bases, including Perko® brand bases.

Perko® is a registered trademark of Perko, Inc.

Standard Pole

Standard pole is used on Attwood all-round, masthead, transom, and bi-color pole lights. Fits all Attwood standard (non-locking-collar) 2- and 3-pin contact bases.

2-Mile All-Round Lights

Attwood all-round lights offer 2-mile, 360° visibility and are suitable on boats up to 39.4 ft. (12 m). Power vessels less than 39.4 ft. may show a single all-round light in lieu of a separate masthead and stern light. Attwood all-round lights are available in a variety of head, pole, and base styles to fit most boats and installation locations. On boats under 12 m, the all-round light is the most important navigation light because it can be seen by others from any direction.

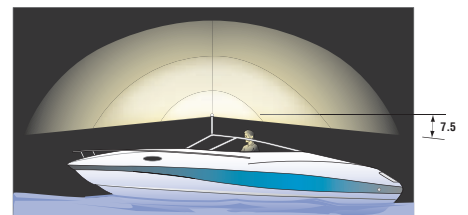
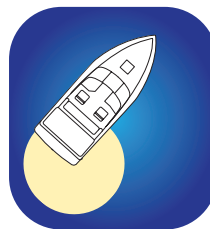

- LED Anti-Glare
- Anti-Glare Lights
- Frosted Globe Lights

Attwood offers a choice of all-round lights — Anti-Glare and Frosted Globe. Select the head, pole, and, base style that best suit your installation location and eliminate driver glare.

Traditional and LED Anti-Glare Lights

Attwood's Anti-Glare All-Round light goes beyond current regulations to reduce the danger of on-board glare. The precision lens focuses the light beam to the horizon where it's needed—360° without diffusion—keeping it out of the driver's field of view. It allows the operator to see while being sure the boat is seen. The bottom aperture eliminates glare by cutting off the light beam at 7.5° below horizontal, so it's out of the driver's view. Above horizontal, the lens shines a continuous arc of light—

allowing improved visibility even when the boat is pitching in rolling seas. The Articulating Anti-Glare Light makes it even easier to eliminate glare. The patented articulating head adjusts from 15° fore to 15° aft to fit all base angles and typical deck installations.

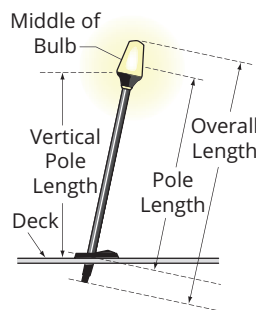

Frosted Globe Lights

Attwood's standard Frosted Globe All-Round light is also available. Offering 360° visibility.

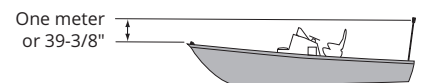

One-Meter Regulation

All-round light must be a minimum of one meter (39-3/8") above the red/green sidelights on boats under 12 m (39.4 ft.). One meter must be the height separation measured from bulb filament centers.

Note: Frosted globe pole lights may be used with straight and angled bases. Unarticulated anti-glare pole lights must be selected to match the appropriate straight or angled base.



All-Round Plug-In Lights

LIGHTARMOR™ LED Fast Action All-Round Navigation Lights

Premium LED lights with a flexible, impact-resistant composite pole make these perfect for anglers and hunters to maneuver through low-hanging obstacles. The subtle, glare-free black matte finish complements many of today's boat designs.

- ISO 19009:2015 Certified
- Meets standards ABYC C-5 & A-16, USCG CFR 183.810
- Impact-resistant polycarbonate lens
- Water resistant
- Corrosion/UV resistant
- Light head adjusts 15° fore to 15° aft
- LED light engines last for 50,000 hours
- 5-year warranty



Threaded Locking Collar fits securely with LightArmor Plug-In Light Bases

5530

Description	Pole Length	OEM Part #	Part #
All-Round Light	24"	5530-24BP1	5530-24BP7
	30"	5530-30BP1	—
	36"	5530-36BP1	5530-36BP7
	42"	5530-42BP1	5530-42BP7
	48"	5530-48BP1	—
	54"	5530-54BP1	5530-54BP7
	60"	5530-60BP1	—



LIGHTARMOR™ LED All-Round Articulating Light

USCG certified. Provides 2-mile 360° visibility for boats up to 39.4 ft (12m)

- LightArmor™ All-Round navigation engine
- 30% lighter than earlier Attwood all-round lights
- Exclusive condensation management increases visibility
- Exclusive anti-glare engine preserves night vision
- Shock-, corrosion-, and water-proof electronics
- Durable, anodized aluminum pole
- Articulating head for use in all applications
- Strong locking-collar secures light in harsh marine conditions
- Standard 2-pin
- Compatible with Attwood and popular bases
- Operating range = 10.5V DC - 14.4V DC
- Over 50,000 hour life
- 5-year warranty



5530

Series	Use with Light Base
5530	910R2, 901V2, 910T2, 2520‡, 911339‡, 911370‡

Description	Pole Length	OEM Part #	Part #
2-Pin Locking-Collar Pole	12"	5530-12T1	—
	24"	—	5530-24A7
	36"	—	5530-36A7
	42"	5530-42T1	5530-42A7
	48"	5530-48T1	5530-48A7
	54"	5530-54T1	5530-54A7
	54", Black	5530-54TB1	—
	60"	5530-60T1	5530-60A7
	66"	5530-66T1	—



OEM Threaded Locking Collar

Aftermarket Dual Locking Collar



‡When locking collar is removed.

LIGHTARMOR™ LED All-Round All-Round Folding Pole Light

USCG certified. Provide 2-mile, 360° visibility for boats up to 39.4 ft. (12 m)

- Meets standards ABYC C-5 & A-16, USCG CFR 183.810
- LightArmor™ All-Round navigation engine
- 30% lighter than earlier Attwood all-round lights
- Exclusive condensation management increases visibility
- Exclusive anti-glare engine preserves night vision
- Shock-, corrosion-, and water-proof electronics
- Durable, anodized aluminum pole
- Standard 2-pin
- Compatible with Attwood and popular bases
- Operating range = 10.5V DC - 14.4V DC
- Over 50,000 hour life
- 5-year warranty

Series	Use with Light Base
5540, 5570	910R2, 901V2, 910T2, 2520‡, 911339‡, 911370‡

‡When locking collar is removed.

Description	Pole Length	OEM Part #	Part #
2-Pin Locking-Collar Pole	54"	5540-54T1	5540-54A7
	60"	5540-60T1	—
	72"	5540-72T1	—
	72"	5540-72TB1*	—
	84"	5540-84T1	—
2-Pin Standard Pole	60"	5570-60-1	—
	72"	5570-72-1	—

‡When locking collar is removed. *Black Aluminum version



2 NM
USCG

Incandescent All-Round Articulating Anti-Glare Light

Attwood's Anti-Glare lights are a great improvement over conventional all-round lights. They focus light at the horizon and above, not in the driver's eyes.

The bottom aperture reduces glare at 7.5° below horizontal. Above horizontal, the lens shines a continuous arc of light in rolling seas. The patented articulating head adjusts from 15° forward to 15° aft. Simply align the lens to the horizon and tighten the adjustment screw. Makes the boat more visible to taller craft such as freighters and commercial vessels.

The All-Round Articulating Anti-Glare Light simplifies inventory for builders and retailers, since one light fits most angles and installations. The locking-collar pole allows installation in 95% of existing bases — Attwood models as well as competitive bases such as Perko® brand, which simplifies installation for consumers.

Perko® is a registered trademark of Perko, Inc.

Series	Use with Light Base
5330	910R2, 901V2, 910T2, 2520* 911339*, 911370*

* When locking-collar is removed.

Description	Pole Length	OEM Part #	Part #
2-Pin Locking-Collar Pole	42"	—	5330-42-7
	48"	—	5330-48-7

2 NM
LEGACY
REPLACEMENT
ONLY



Incandescent All-Round Folding Pole Light

All-round lights must be at least one meter above sidelights, which requires a longer pole light that is difficult to store for some boats. Attwood's All-Round Folding Pole light solves this problem. It has all the features of the patented Articulating Anti-Glare Light, plus one great advantage — the removable pole folds in half for easy storage. The mid-point hinge is a corrosion-resistant, glass-filled composite. Wiring is sheathed at the hinge for trouble-free operation.

Series	Use with Light Base
5340	910R2, 901V2, 910T2, 2520‡, 911339‡, 911370‡

‡When locking collar is removed.

Description	Pole Length	OEM Part #	Part #
2-Pin Locking-Collar Pole	54"	—	5340-54-7

2 NM
LEGACY
REPLACEMENT
ONLY



Incandescent All-Round Frosted Globe Light

Provides 2-mile, 360° illumination for boats up to 39.4 ft (12 m). Includes 9W wedge-base lamp.

Series	Use with Light Base
5100, 5110	910R2, 901V2, 910T2, 2520‡, 911339‡, 911370‡

‡When locking collar is removed.

Description	Pole Length	OEM Part #	Part #
2-Pin Locking-Collar Pole	24"	—	5110-24-7
	30"	—	5110-30-7
	36"	—	5110-36-7
	42"	—	5110-42-7
	48"	—	5110-48-7
	54"	—	5110-54-7

2 NM
LEGACY
REPLACEMENT
ONLY



Incandescent Telescoping Pole Light

Stores easily in less space than a conventional All-Around light and can be removed quickly from any Attwood pole light base. Aluminum pole telescopes from 30" to 48". Provides 2-mile, 360° illumination for boats up to 39.4 ft (12 m). Includes 12W lamp.

Description	Pole Length	OEM Part #	Part #
Telescoping Pole Lights	30" - 48"	—	5610-48-7

2 NM
LEGACY
REPLACEMENT
ONLY



Incandescent Stowaway Light with Plug-In Base

Swivel cover on base protects the socket when light is stowed. Base extends just 3" below deck. 4" L x 1-5/8" W x 1-3/8" dia. Provides 2-mile, 360° illumination for boats up to 39.4 ft (12 m). Includes 911339 base and 9W wedge-base lamp. Three countersunk holes for #10 fasteners.

Description	Pole Length	OEM Part #	Part #
2-Pin Standard Pole with 911339 Base	24"	—	7100A7
	30"	—	7100B7
	36"	—	7100C7

2 NM
LEGACY REPLACEMENT ONLY

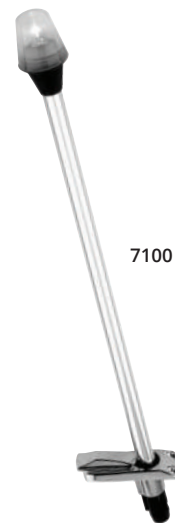

All-Round Plug-In Bases

LIGHTARMOR™ Plug-In Bases

LightArmor™ Plug-In Light Bases are designed for premium performance, durability, and attractive styling that helps them stand out. This combination of intelligent design and engineering make them worthy of the Light Armor name.

They're a Sure Fit

The threaded design feature fits perfectly with the threaded locking collar now offered across the entire line of Attwood pole lights. This unique system ensures a tight and secure fit that prevents annoying rattling while underway or trailering.

Plenty of Style Choices

The upgraded styling and appearance comes in three popular shapes and a range of material finishes, including Composite, 316 Stainless Steel, and Stainless Steel Overmold, that are sure to appeal to everyone.

Other Key Features

- Unique cover design ensures that the cover stays in place
- Low-profile prevents water from pooling on the top surface
- 2-and 3-pin options



910V Series: Rectangle

LIGHTARMOR™
PLUG-IN BASES

910R Series: Round

910T Series: Teardrop

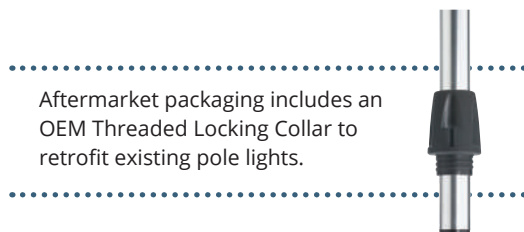

LIGHTARMOR™ 910V Series Rectangle Base

Classic rectangle design is available in Black Composite and 316 Stainless Steel.

Light Base	Use with Pole Light	
910V2	LED Anti-Glare: 5530 and 5540 Series Bi-Color: NV6LC1, 5092, and 5091 Series Frosted Globe: 5110 Series Anti-Glare: 5310, 5320, 5330, and 5340 Series	
910V3	Bi-Color: NV6LC2 and 5095 Series	
Description	OEM Part #	Part #
2-Pin Light Base		
Black Composite Cover	910V2PB-1	910V2PB-7
316 Stainless Steel	910V2SS-1	910V2SS-7
3-Pin Light Base		
Black Composite Cover	910V3PB-1	910V3PB-7
316 Stainless Steel	910V3SS-1	910V3SS-7



LIGHTARMOR™ 910R Series Round Base

Round base is available in Black Composite, and 306 Stainless Steel Overmold (black and white).

Light Base	Use with Pole Light	
910R2	LED Anti-Glare: 5530 and 5540 Series Bi-Color: NV6LC1, 5092, and 5091 Series Frosted Globe: 5110 Series Anti-Glare: 5310, 5320, 5330, and 5340 Series	
910R3	Bi-Color: NV6LC2 and 5095 Series	
Description	OEM Part #	Part #
2-Pin Light Base		
Black Composite Cover	910R2PB-1	910R2PB-7
Overmold 306 Stainless Steel Black Cover	910R2PSB-1	910R2PSB-7
Overmold 306 Stainless Steel White Cover	910R2PSW-1	—
3-Pin Light Base		
Black Composite Cover	910R3PB-1	910R3PB-7
Overmold 306 Stainless Steel Black Cover	910R3PSB-1	910R3PSB-7



LIGHTARMOR™ 910T Series Teardrop Base

Elegant teardrop base is available in Black Composite, and 306 Stainless Steel Overmold (black and white).

Light Base	Use with Pole Light	
910T2	LED Anti-Glare: 5530 and 5540 Series Bi-Color: NV6LC1, 5092, and 5091 Series Frosted Globe: 5110 Series Anti-Glare: 5310, 5320, 5330, and 5340 Series	
910T3	Bi-Color: NV6LC2 and 5095 Series	
Description	OEM Part #	Part #
2-Pin Light Base		
Black Composite Cover	910T2PB-1	910T2PB-7
Overmold 306 Stainless Steel Black Cover	910T2PSB-1	910T2PSB-7
Overmold 306 Stainless Steel White Cover	910T2PSW-1	—
3-Pin Light Base		
Black Composite Cover	910T3PB-1	910T3PB-7
Overmold 306 Stainless Steel Black Cover	910T3PSB-1	910T3PSB-7
Overmold 306 Stainless Steel White Cover	910T3PSW-1	—



Square 2-Pin Base for Straight Poles

2-pin base for traditional-style Attwood pole lights, constructed of nylon. Hinged cover snaps closed to keep dirt and water out when light is stowed. Socket is keyed to prevent incorrect insertion of pole lights. Four countersunk holes for installation of fasteners. Includes 7-1/2" hard wire leads for connection to 12V DC power supply.

- Dimensions: 2-1/4" x 1-3/4". 1-1/4" diameter installation hole size.
- Contacts are nickel-plated to resist corrosion and multi-crimped for durability.
- Wire leads are tinned for corrosion-resistance.

Light Base	Use with Pole Light	
911370	LED Anti-Glare: 5570 Series Bi-Color: 5091 Series Frosted Globe: 5100 Series Anti-Glare: 5300 Series	
Description	OEM Part #	Part #
2-Pin, Black	911370-1	—



For Use with Standard Pole

911370, 911445

Vertical Mount with Pin Contacts for Straight Poles

Can be mounted on flat windshield frame and includes a "V" adapter for mounting on angled windshield frame. Also for use as a transom mount in open utility boats. Black plastic with hinged lid that closes to keep dirt and water out when stowed away. Two holes for #8 screws. Includes 7-1/2" hard wire leads for connection to 12V DC power supply.

- Dimensions: 4-1/4" x 1-1/2" x 1-1/8"
- Contacts are nickel-plated to resist corrosion and multi-crimped for durability.
- Wire leads are tinned for corrosion-resistance.

Light Base	Use with Pole Light
911370	LED Anti-Glare: 5570 Series Bi-Color: 5091 Series Frosted Globe: 5100 Series Anti-Glare: 5300 Series
Description	OEM Part # Part #
2-Pin, Black	911490-1 —



Oval 2-Pin Base for Angled Pole

This resilient 2-pin base is used for angled pole lights with locking-collars. Ideal for installation in close quarters, such as narrow gunwales or deck areas. Narrow base has a soft rubber cover with a gasket to seal the socket.

- Contacts are nickel-plated to resist corrosion and multi-crimped for durability.
- Wire leads are tinned for corrosion-resistance.

Light Base	Use with Pole Light
91022	Frosted Globe: 5110 Series Anti-Glare: 5310, 5330 and 5340 Series LED Anti-Glare: 5530 and 5540 Series Bi-Color: 5091 Series
Description	OEM Part # Part #
2-Pin, Black	91022-1 91022-7

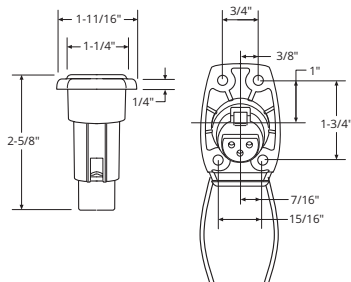

Rectangle 2-Pin Base for 12° Angled Pole

Swivel cover protects the socket when light is stowed away. Socket is keyed to prevent incorrect insertion of pole light. Three countersunk holes for installation fasteners. Includes 7-1/2" hard wire leads for connection to 12V DC power supply.

- Dimensions: 4" x 1-5/8". 1-3/8" dia. installation hole size.
- Contacts are nickel-plated to resist corrosion and multi-crimped for durability.
- Wire leads are tinned for corrosion-resistance.

Light Base	Use with Pole Light
911339	Frosted Globe: 5110 Series Anti-Glare: 5300 Series Bi-Color: 5091 Series
Description	OEM Part # Part #
2-Pin, ZAMAK	911339-1 911339-7



PowerBase Series NEW

The intelligent, automated folding light and Antenna.

Why PowerBase

PowerBase easily stows and deploys lights and antennas with the push of a button

PowerBase is the only intelligent light/antenna with object detection technology

- SafeGuard Breakaway – In the event of an impact, PowerBase will breakaway towards stowed position preventing potential damage to fiberglass top.
- SmartDeploy Backdrive – In the event of a blocked deployment, PowerBase senses an obstruction and reverses the light/antenna back to its starting position.

PowerBase is designed for worry-free installation and operation from assembly line to marina

- Standardized mounting patterns allow for upgradeability.
- Intuitive control without switch limitations.

PowerBase is compatible/built with the leading industry equipment

- For use with antennas up to 8 ft. in length (Powerbase Antenna).
- Available in masthead and all-round configurations featuring Attwood's LightArmor LED technology (PowerBase Light).



Additional Features

Powered Fold-down Control at the Helm	Easily fold down navigation lights and antennas without needing to dangerously climb seats, ladders, or gunwales
Safeguard Breakaway	Keep peace of mind knowing that upon impact with a bridge or branch, unit will breakaway preventing damage to your light, antenna, and hard-top
SmartDeploy Backdrive	Deploy lights and antennas without worry as the unit senses obstructions and automatically retracts – all the while notifying you of the obstruction
Intuitive Control Without Switch Limitations	Simplistic control scheme ensures boaters are always kept in control, without forcing proprietary switches
Visual System State Feedback	LED feedback makes boaters aware of failures to ensure that they're always compliant, even if there is a mechanical/electronic failure on the vessel
Uses Existing Standardized Mounting Patterns	Ensures builders and boaters alike can utilize existing tooling to replace current manual fixtures
Follows Existing Wiring Paths	Wiring follows path of existing manual fold-down lights to the digital/analog switch for feedback and control
Manual Adjustment Failsafe	Easy to use manual override ensures boaters can always deploy lights in the event of system failure
180° Range of Motion	PowerBase may be mounted so that the light/antenna folds toward a boat's stern or bow





Part #	PowerBase Antenna	PowerBase Light	LightArmor All-Round Navigation Light			LightArmor Masthead/Anchor Navigation Light		
			OEM	AFT		OEM	AFT	
	6100-AT-1 (OEM)	6100-LT-1 (OEM)	24"	5590-24-1	5590-24-7	24"	7800-24-1	7800-24-7
	6100-AT-7 (AFT)	6100-LT-7 (AFT)	30"	5590-30-1	5590-30-7	—	—	—
			36"	5590-36-1	5590-36-7	36"	7800-36-1	7800-36-7
			42"	5590-42-1	5590-42-7	42"	7800-42-1	7800-42-7
Compatibility	Compatible with all leading 1-1/4" threaded VHF Antennas (8ft or less length)	Compatible with Attwood LightArmor LED All-Round and Masthead Nav Lights	For powered vessels under 39.4'			For powered vessels between 39.5'-65'		

Description	Part #
Shear Pin for PowerBase	6001-7

PowerBase Mounting Pattern Compatibility / Attachment Options

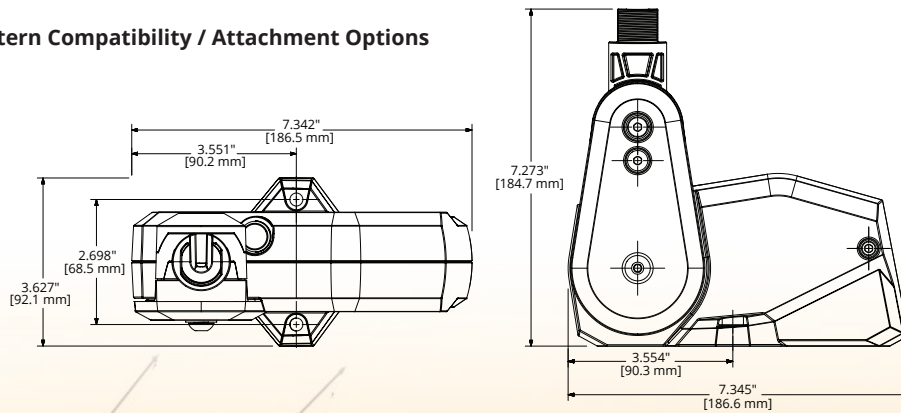

All-Round Fold-Down Lights

All Attwood All-Round Fold-Down Navigation Lights include a durable, easy-to-use, easy-to-install, LightArmor™ Fold-Down Base.

- Robust design provides easy, single-handed cam-lock operation
- Built to last in harsh marine environments

LIGHTARMOR™ LED All-Round Fold Down Navigation Lights

- Meets standards ABYC C-5 & A-16, USCG CFR 183.810
- USCG certified
- Provides 2-mile, 360°, illumination for boats up to 39.4 ft. (12m)
- Operating range = 10.5V DC - 14.4V DC
- LightArmor™ All-Round navigation light engine
- 30% lighter light engine than earlier Attwood all-round lights
- Exclusive condensation management increases visibility
- Exclusive anti-glare engine preserves night vision
- Shock-, corrosion-and water-proof electronics
- Durable, anodized aluminum pole
- Articulating head for use in all applications
- Includes new LightArmor Fold-Down Base
- Long-lasting LED technology (20-year expected life)

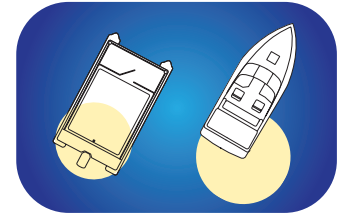
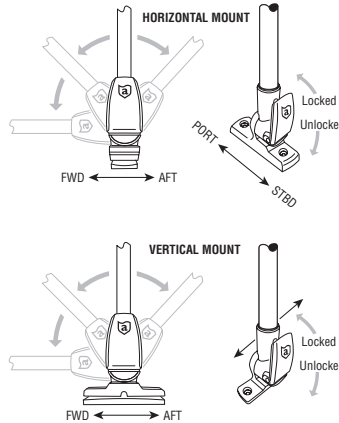

2 NM
USCG

LED Articulating Anti-Glare

Draws 20% less power than traditional all-round lights
5550 Series



Description	Pole Length	OEM Part #	Part #
LED ANTI-GLARE LIGHTS			
ZAMAK base-Horizontal Mount	12" Aluminum Pole	5550-12Z1	—
	24" Aluminum Pole	5550-24Z1	—
	30" Aluminum Pole	5550-30Z1	—
	36" Aluminum Pole	5550-36Z1	—
Stainless steel base-Horizontal Mount	12" Aluminum Pole	5550-S12-1	—
	18" Aluminum Pole	5550-S18-1	—
	24" Aluminum Pole	5550-S24-1	—
	30" Aluminum Pole	5550-S30-1	—
	36" Aluminum Pole	5550-S36-1	—
Composite base; Black-Horizontal Mount	42" Aluminum Pole	5550-S42-1	—
	12" Aluminum Pole	5550-P12-1	—
	20" Aluminum Pole	5550-P20-1	—
Composite base; Black-Horizontal Mount with Adaptor	24" Aluminum Pole	5550-P24-1	—
	12" Aluminum Pole	—	5557-P12A7
	12" Plastic; Black Pole	—	5558-P12A7
Composite base; Black-Vertical Mount	20" Aluminum Pole	—	5550-PA20-7
	12" Aluminum Pole	5551-P12-1	—
Composite base; Black-Vertical Mount with Adaptor	12" Aluminum Pole	5557-PV12A7	—
	20" Aluminum Pole	—	5551-PA20-7
FOLD-DOWN ADAPTOR			
Rail Mount Adaptor, Black Composite		913670-1	—
Rail Mount Adaptor, Stainless Steel		913671-1	—

▣ All Aftermarket Packaged lights include Rail Mount Adaptor

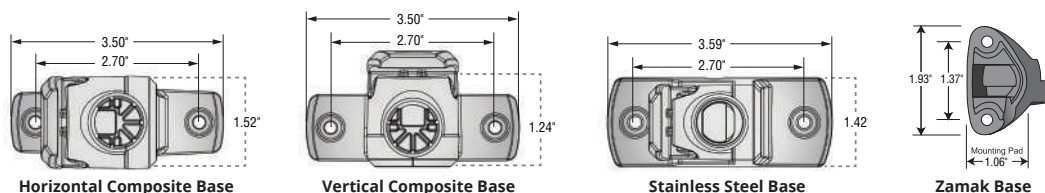

Incandescent All-Round Fold-Down Lights

- Provides 2-mile, 360°, illumination for boats up to 39.4 ft. (12m)
- Incandescent All-Round navigation light engine
- Shock-, corrosion-and water-proof electronics
- Durable, anodized aluminum pole
- Anti-glare lens preserves night vision
- Meets USCG standards
- Assembled with Attwood's new LightArmor bases
- Black composite cam-lock base
- Stainless steel cam-lock base
- Zamak knob-style base

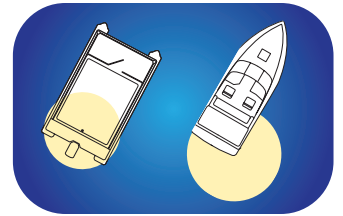
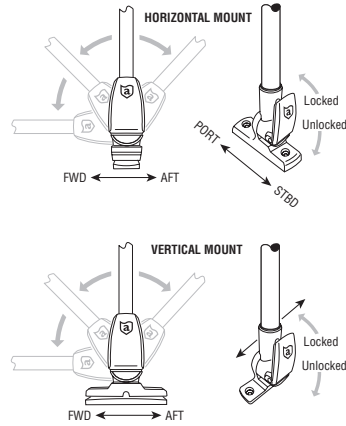

Articulating Anti-Glare
 Include 9W wedge base lamp
5350 Series

2 NM
 LEGACY REPLACEMENT ONLY

Description	Pole Length	OEM Part #	Part #
ANTI-GLARE LIGHTS			
Composite Base; Black-Horizontal Mount with Adaptor	12" Aluminum	—	5350-PA12-7 [Ⓜ]
	12" Black Plastic	—	5358-P12-7 [Ⓜ]
	20" Aluminum	—	5350-PA20-7 [Ⓜ]
FOLD-DOWN ADAPTOR			
Rail Mount Adaptor, Black Composite		913670-1	—

[Ⓜ] All Aftermarket Packaged lights include Rail Mount Adaptor

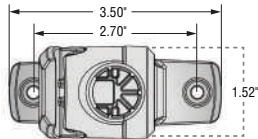

Horizontal Composite Base

913670



All-Round Fixed Base Lights

LIGHTARMOR™ LED Waketower All-Round Light

Compact size designed for installation on a wakeboard tower, radar arch, hard top, poling platform, tuna tower, or other fixed structure. Direct LED replacement for Attwood's incandescent 5940 series. For pleasure craft up to 39.4 ft (12 m).

- Two-mile, 360° visibility
- Fully sealed electronics
- Tab release

Description	OEM Part #	Part #
6" Wire Leads	5580-1	5580A7
12" Wire Leads, No Sleeve	5582-1	—
16' Wire Leads	5581-1	—
Replacement Base	5580-03	—

2 NM
USCG

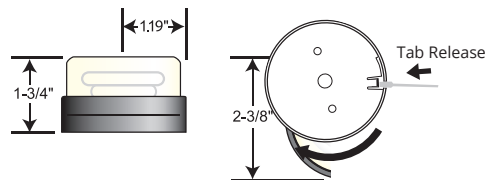

5580



5580-03

Incandescent All-Round Deck Mounted Lights

7-inch leads for connection to 12V DC power supply. Bayonet lock secures lens and cover to base and provides easy lamp replacement. Includes a 9W wedge base lamp. Installs directly to deck with two required #10 fasteners.

Deck Mount

Light mounts flush, making it ideal for installation atop the tow piece on ski or wakeboard boat towers.

Description	OEM Part #	Part #
Deck Mount, Black	—	5940-7

2 NM
LEGACY
REPLACEMENT
ONLY



5940

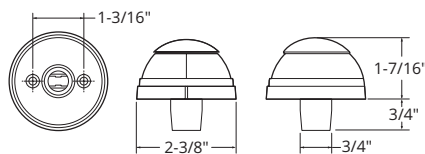

Transom Lights

LED 3-Mile Transom Light

For pleasure craft up to 65.6 ft. (20m) in length. Creating 135 degrees of light at 3-mile of visibility. A truly unique design, Attwood's transom light includes a luxurious electropolished stainless cover that is both durable and great looking. Easy-to-install surface mount design utilizes a snap feature to eliminate exposed fasteners. 3" diameter.

- One of the thinnest lights available - 1/2" height
- Compatible with both Attwood and Perko® mounting holes
- Meets standards ABYC C-5 & A-16, USCG CFR 183.810

Description	OEM Part #	Part #
Stainless Steel	6556-1	6556-7

3 NM
USCG

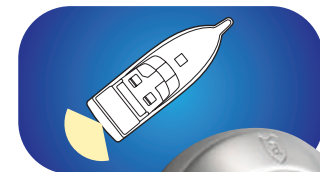

6556

Anchor/Masthead Lights

LIGHTARMOR™ LED Anchor/Masthead Lights

Attwood is proud to introduce one of the most innovative navigational lighting products available today. Achieving 3NM of 360° visibility, while drawing a fraction of the power of traditional incandescent lights, Attwood's 3NM LightArmor™ LED Masthead/Anchor light is one of the first of its kind. Constructed of corrosion resistant composites with stainless steel accents, this product was designed for harsh coastal marine environment.

- USCG certified for boats up to 65' (20m)
- Meets standards ABYC C-5 & A-16, USCG CFR 183.810
- Provides 3-mile, 360° illumination
- Light Armor Anchor/Masthead navigation light engine
- Shock-, corrosion-and water-proof electronics
- Durable, anodized aluminum pole
- Includes new LightArmor Fold-Down Base
 - Cam-lock bases include integrated wire-management
 - Easy, single-handed cam-lock operation
 - Stainless steel
- Over 50,000 hour life
- 5-year warranty

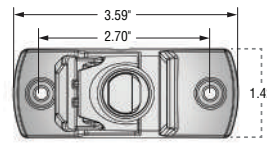

Stainless Steel Base

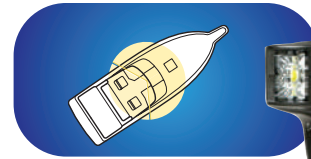

7812



LIGHTARMOR™
Stainless Steel Horizontal Base

Description	Rated Voltage	Pole Length	OEM Part #	Part #
Stainless Steel - Horizontal Mount	12V	12" Aluminum	7812-S-1	7812-S-7
	12V	24" Aluminum	7824-S-1	—
	12V	36" Aluminum	7836-S-1	—
	12V	42" Aluminum	7842-S-1	—
ZAMAK - Horizontal Mount	12V	12" Aluminum	7812Z1	—



For base dimensions see page 70

ZAMAK Base

Stainless Steel Base

Incandescent Anchor/Masthead Lights

Three-mile, 360° light visibility for use on boats up to 65.6 ft. (20 m). Assembly includes new LightArmor™ bases.

- Robust and easy to use
- Freshwater and saltwater compatible
- Simple, one-piece lens is sealed from water
- Concealed, protected wiring at the base
- Uses two festoon-style 8W lamps
- Typical installation requires (2) #10 stainless steel screws of length suitable for deck or rail material
- Will collapse and not break if accidentally hit

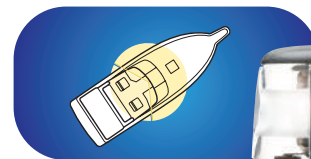
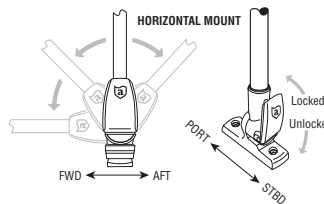

913671



913670

Description	Base	Rated Voltage	Pole Length	OEM Part #	Part #
Horizontal Mounted with rail adaptor	Composite; Black	12V	12" aluminum	—	7201-P-7
	Composite; Black	12V	20" aluminum	—	7202-P-7
Rail Mount Adaptor for Fold-Down light base	Composite; Black	—	—	913670-1	—
	Stainless Steel	—	—	913671-1	—

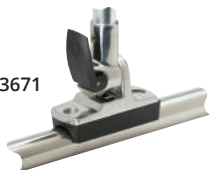

Spotlights



3 YEAR WARRANTY

Precision Wireless Controlled Spotlight

- Universal 12V/24V circuit with bright 100W, H3 halogen bulb
- UV resistant, IP56 Weatherproof ABS housing and Lexan® lens
- O-ring sealed housing, designed for the harsh marine environment - moisture, salt, shock and vibration tested
- Universal snap-in mounting system (can be mounted upside down)
- Super-quiet, all-weather motor with limit stops provides a full range of coverage
- 370° sweep and 120° tilt (75° up and 45° down)
- One-touch auto sweep and S.O.S. function
- Wireless dash mount remote standard; (hard wired & handheld remotes are optional)
- Three-year limited warranty
- Available in white, black and chrome



Bulb:	100 Watt, H3 Halogen
Power (Input voltage):	12V or 24V
Current draw (idle/in use):	0.03A / 7.0A
Peak Beam Intensity:	210,000 Cp
Peak Beam Distance:	917 ft (280 m)
Lux @ 66' (20 m):	525 Lux
Coverage at 66' (20 m):	132 sq ft (12 sq m)
Rotation:	370° (built in limit stops)
Tilt:	120° Tilt (75° up & 45° down)
Wireless range:	200 ft (65 m)
Dimensions:	7.5"W x 7.5"H x 9.25"D (19 x 19 x 23.5 cm)
Weight:	3.30 lbs (1.5 kg)
Housing material:	UV resistant PC/ASA
Lens material:	UV resistant Lexan®
operating temp range:	5°F-113°F (-15°C-45°C)
IP Rating:	IP56 (see inside back cover)

Spotlights

TRANSITIONING 2024

Description	Color	Marinco Part #	Marinco OEM #	Attwood Part #	Attwood OEM #
12V/24V, 100 Watt	white	SPL-12W	—	SPL-12W-4	—
12V/24V, 100 Watt	black	SPL-12B	—	SPL-12B-4	—
12V/24V, 100 Watt	chrome	SPL-12C	—	SPL-12C-4	—
12V, 100 Watt	white	—	SPL-12W.OEM	—	SPL-12W.OEM-1
12V, 100 Watt	black	—	SPL-12B.OEM	—	SPL-12B.OEM-1
12V, 100 Watt	chrome	—	SPL-12C.OEM	—	SPL-12C.OEM-1
24V, 100 Watt	white	—	SPL-24W.OEM	—	SPL-24W.OEM-1
24V, 100 Watt	black	—	SPL-24B.OEM	—	SPL-24B.OEM-1

Replacement Bulbs

TRANSITIONING 2024

Description	Marinco Part #	Attwood Part #
12V, H3 Halogen	202319	202319
24V, H3 Halogen	202320	202320



TRANSITIONING 2024

Starting Jan 1st 2024, select MarincO items will become Attwood branded. Same great product, but now available through Attwood.

Remote Options

TRANSITIONING 2024



Marinco Part #	SPLR-2 (Included)	SPLR-1 (Included)	SPLR-3 (Included)
Attwood Part #	SPLR-2-4 (Included)	SPLR-1-4 (Included)	SPLR-3-4 (Included)
Remote Specifications	Wireless Communication Bridge Remote	Hand Held Bridge Remote	Wired Bridge Remote
Power	12V or 24V (hard wired)	CR2450 button cell battery	12V or 24V (hard wired)
Current draw (idle / in use)	negligible	negligible	negligible
Wireless range	200 ft (65m)	200 ft (65m)	—
Estimated battery life	—	> 40 hours (continuous use)	—
Dimensions	3.5"W x 2.25"H x .75"D 88 x 57 x 19 mm	2.0"W x 3.78"H x 1"D 51 x 96 x 25 mm	3.5"W x 2.25"H x .75"D 88 x 57 x 19 mm
Weight	2.12 oz (60g)	2.82 oz (80g)	2.12 oz (60g)
Housing material	UV resistant PC/ASA	UV resistant PC/ASA	UV resistant PC/ASA
Button material	Silicone (glow in the dark)	Silicone (glow in the dark)	Silicone (glow in the dark)
Operating temp range	5°F-113°F (-15°C-45°C)	5°F-113°F (-15°C-45°C)	5°F-113°F (-15°C-45°C)
IP Rating	IP53 (see inside back cover)	IP54 (see inside back cover)	IP53 (see inside back cover)

IP67 Halogen Stainless Steel Spot/Floodlight

- Wireless remote communication
- 316 stainless steel base, 304 stainless steel head
- 350° horizontal, 60° vertical two speed movement

Peak beam intensity	165,000 CP spot
Amp draw	Spot 8.3A, flood 7.5A @ 12V Spot 4.15A, flood 3.75A @ 24V
Power (Input voltage)	12V & 24V
Bulb	H4 halogen
Dimensions	9.875"H x 4.75"W x 8.35"L
Weight	6 lbs.
IP Rating	IP67 (see inside back cover)

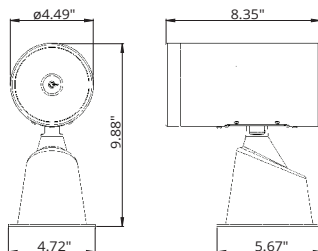

3 YEAR WARRANTY

Remote Options



TRANSITIONING 2024			
Marinco Part #	22250-R	22350-R	22250-HH
Atwood Part #	22250-R-4	22350-R-4	22250-HH-4
Voltage	12V	24V	12/24V
Power	12V DC	24V DC	Battery: L1028F Alkaline 12V
Remote Specifications	Wireless Communication Bridge Remote		Hand Held Bridge Remote
Wireless range	100 ft (30m)		100 ft (30m)
Dimensions	2.2"W x 3.65"H x 0.9"D		2.25"W x 3.95"H x 1.2"D
Housing material	ASA		ASA
Button material	Silicone (glow in the dark)		Silicone (glow in the dark)

TRANSITIONING 2024

Description	Marinco Part #	Atwood Part #
12V Spot/Flood with Remote (22250-R)	22050A	22050A-4
12V Spot/Flood Only	22051A	22051A-4
24V Spot/Flood with Remote (22350-R)	22150A	22150A-4

IP67 LED Stainless Steel Spotlight

- Wireless remote communication
- 316 stainless steel base, 304 stainless steel head
- 350° horizontal, 60° vertical two speed movement

Light Output	92,000 CD
Amp Draw	3A @12V DC 1.5A @24V DC
Power (Input voltage)	12V or 24V DC
# of LEDs	12
Dimensions	9.875"H x 4.75"W x 8.35"L
Weight	11.36 lbs (5.2 kg)
IP Rating	IP67 (see inside back cover)

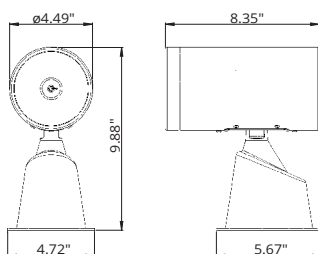

3 YEAR WARRANTY

Remote Options



TRANSITIONING 2024			
Marinco Part #	23250-R	23350-R	23250-HH
Atwood Part #	23250-R-4	23350-R-4	23250-HH-4
Voltage	12V	24V	12/24V
Power	12V DC	24V DC	Battery: L1028F Alkaline 12V
Remote Specifications	Wireless Communication Bridge Remote		Hand Held Bridge Remote
Wireless range	100 ft (30m)		100 ft (30m)
Dimensions	2.2"W x 3.65"H x 0.9"D		2.25"W x 3.95"H x 1.2"D
Housing material	ASA		ASA
Button material	Silicone (glow in the dark)		Silicone (glow in the dark)

TRANSITIONING 2024

Description	Marinco Part #	Atwood Part #
12V Spotlight with Remote (23250-R)	23050A	23050A
12V Spotlight Only	23051A	23051A
24V Spotlight with Remote (23350-R)	23150A	23150A

TRANSITIONING 2024

Starting Jan 1st 2024, select Marinco items will become Atwood branded. Same great product, but now available through Atwood.

5" Stainless Steel Spot/Floodlight

- Remote control, joystick operation
- 316 stainless steel base, 304 stainless steel head
- Light can be directed manually without damaging motors
- One year warranty

Spot Power:	72,000 CP
Flood Power:	30,000 CP
Amp Draw:	7A
Operation:	12V Incandescent
Bulb:	Replaceable Incandescent
Lamp Dimensions:	9.5" H x 4.5" W x 7.5" L
Base Dimensions:	5.5" L x 3.5" W
Weight:	6 lbs (2.7 kg)
Joystick requires:	2.75" installation hole



Spot/Flood kit includes joystick control and 15' wiring cable with easy to install plug ends

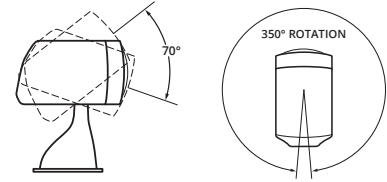

TRANSITIONING 2024

Description	Marinco Part #	Attwood Part #
Spot/Flood Kit	22040A	22040A-4
Spot/Flood Only	22041A	22041A-1
Replacement Bulb	22014-P	22014-P-1

Spotlight Parts & Accessories

Stainless Steel Spot/Flood Parts and Accessories

TRANSITIONING 2024

Part #	Marinco Oval Panel	Marinco Rectangular Bulb Kit	Marinco Replacement Bulb Kit	Part #	Attwood Oval Panel	Attwood Rectangular Control	Attwood Replacement Bulb Kit
22040A	22240-R	22208A	22014-P	22040A-4	22240-R-5	22208A-5	22014-P-1
22041A	22240-R	22208A	22014-P	22041A-1	22240-R-5	22208A-5	22014-P-1

Beamer™ Parts and Accessories

TRANSITIONING 2024

Part #	Marinco Control Panel	Marinco Dual Station Control Kit	Marinco Replacement Bulb Kit	Wires in Cable	Part #	Attwood Control Panel	Attwood Dual Station Control Kit	Attwood Replacement Bulb Kit	Wires in Cable
500, 500A	729823-P	729823-P	729493	1	500, 500A	729823-P-5	729823-P-5	729493-5	1
501, 501A	—	—	729493	Wireless	501, 501A	—	—	729493-5	Wireless
502-1	—	—	729493	5	502-1	—	—	729493-5	5
503, 503A	729829-P	—	729494	6	503, 503A	729829-P-5	—	729494-5	6

M100 Remote Halogen Spot Parts and Accessories

TRANSITIONING 2024

Part #	Marinco Joystick Control	Attwood Joystick Control
22200	22209	22209-5
22201	22209	22209-5

Cables

TRANSITIONING 2024

Length	Marinco Replacement Male to Male	Attwood Replacement Male to Male
25 ft	22011A-P	22011A-P-5
35 ft	22012A-P	22012A-P-5



Use with: 22040A, 22041A, 22044, 22045, 22200 or 22201 Lights

TRANSITIONING 2024

Starting Jan 1st 2024, select Marinco items will become Attwood branded. Same great product, but now available through Attwood.

LED Portable Lighting

For nighttime operation of small boats and tenders without 12V electrical systems. These lights are not intended to meet U.S. Coast Guard regulations. Not for use on boats that can exceed speeds of seven knots.

LED Portable Navigation Light Kit

Be seen and be safe with these compact and portable LED navigation lights. All new portable navigation lights are more durable, easier to use, and include Attwood's strongest mounting and pole configurations. Ideal for personal water craft, camping, and hunting. Kit includes red/green LED bow light, white LED stern light, quick-release mounts, pole, and hardware.

- Water-resistant bow and stern navigation lights
- Attwood's most durable, portable LED navigation light engines
- Sealed electronics, built to last in harsh conditions
- Sealed, shock-proof composite housing
- Shatter-proof polycarbonate lens
- 150+ hour run-time on three AAA batteries (not included)
- New telescoping and threaded poles
- New heavy-duty C-clamp and kayak pad mounting options



Description	Finish	Pole Style	Mounting Style	OEM Part #	Part #
Clamp-On	Marine Gray	Threaded	C-Clamp	—	14190-7
	Real Tree® Max-5 Camouflage	Threaded	C-Clamp	—	14191-7
	Marine Gray	Telescoping	C-Clamp	—	14194-7
	Real Tree® Max-5 Camouflage	Telescoping	C-Clamp	—	14195-7
Deck Mount	Marine Gray	Telescoping	Optional screw-down or adhesive pad	—	14192-7
	Real Tree® Max-5 Camouflage	Telescoping	Optional screw-down or adhesive pad	—	14193-7
All-Craft Navigation	Marine Gray	Threaded	C-Clamp, screw-down and adhesive pad	—	14196-7
	Real Tree® Max-5 Camouflage	Threaded	C-Clamp, screw-down and adhesive pad	—	14197-7

LED Multi-Function Sport Light

Durable, water-resistant, multi-purpose light can be used as a bright 300 fixture lumen flood light or 50 lumen red beam for improved night vision. Also has a UV mode for charging fishing lures and line. Ideal for fishing, boating, hunting, camping and more. Features four mounting options and 360° rotation. Includes an adapter for use with Attwood rod holder mount. Requires six AA batteries (not included).

Description	OEM Part #	Part #
Multi-Purpose Light, marine gray	—	14185XFS-7
Multi-Purpose Light, camouflage	—	14187XFS-7



REALTREE MAX-5

LED Docking Lights

LED Docking Lights

- Light draws a fraction of the power while producing a brighter output. 5 watts at 12V DC each. Transmits light in a much broader pattern as opposed to a narrow beam generated by today's competitors.
- At less than 1" thick, the lights are designed to be mounted directly to the surface of the hull with only a small hole for wiring. Requires (3) #8 stainless steel Phillips Head screws (not included).
- Attwood LED technology keeps the light cool to the touch.
- Backed by a 5-year warranty, Attwood's LED docking lights are designed with the most extreme conditions in mind. Attwood uses only the highest grade stainless and aluminum components to ensure the product will be resistant to corrosion.
- To ensure the light is watertight, all electrical components are fully sealed.
- Attwood's simple one-piece cover allows for the ultimate in customization.
- 4-inch lead wires

Attwood LED Docking Light vs. Halogen Current Draw (Amps)

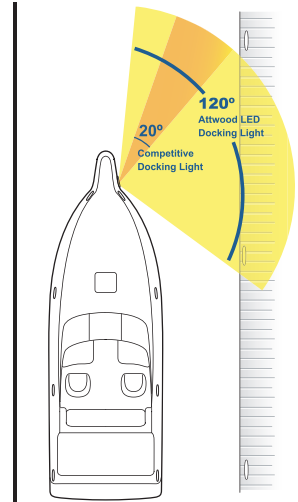
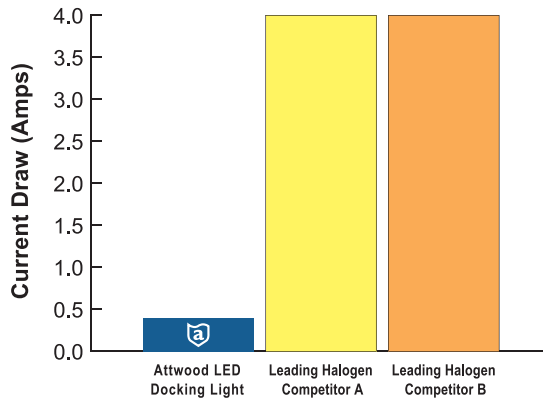

6521SS



6522SS

6523BK

Description	Dimensions	OEM	
		Part #	Part #
Stainless Steel Bezel, White LED, Pair	4-1/8" H x 8-1/8" W x 3/4" D	6521SS1	—
Stainless Steel Bezel, White LED, Pair	1.2" H x 4.5" W x 2.8" D	6522SS1	6522SS7
Black Powder Coat Bezel, White LED, Pair	1.2" H x 4.5" W x 2.8" D	6523BK1	6523BK7

LED Underwater Lights

LIGHTARMOR™ LED Underwater Lights

Introducing LightArmor™ Underwater Lights from Attwood, a new line of premium surface-mount LED lights that are engineered to be the brightest and most durable lights in the industry. Like all LightArmor™ products, they're technically advanced, built to perform in the harshest marine environments, and backed by an industry-leading 5-year warranty.

- 12V and 24V DC systems
- Intelligently engineered for strength and durability
- Exclusive Heat-Sync Cooling System with Active Overheat Protection
- Resistant to corrosion, chemicals, and UV damage
- Extreme impact-resistant lens
- 3 ft. sheathed wire
- Reverse polarity protection
- Fully-sealed waterproof electronics
- Simple installation with minimal mounting hardware
- Low-profile design
- Electro-polished 316 stainless steel cover (Optional for OEM)
- CE certified



Three popular sizes - 4", 5", 6"

Three vibrant colors - Sapphire Blue, Intense White, Tactical Green

Two performance levels - High Performance (HP), Extreme High Performance (HPX)

Note: All Light Armor Underwater lights MUST BE MOUNTED UNDER WATER LINE. Only work underwater.

Outshining the Competition.

LIGHTARMOR™ Underwater Lights are the brightest on the market.

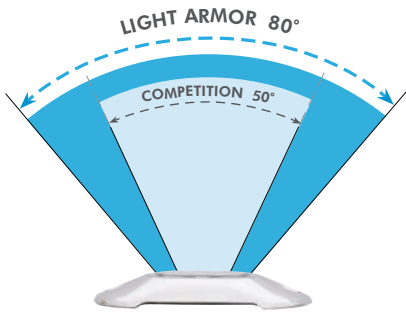

Projection Intensity vs. Competitor

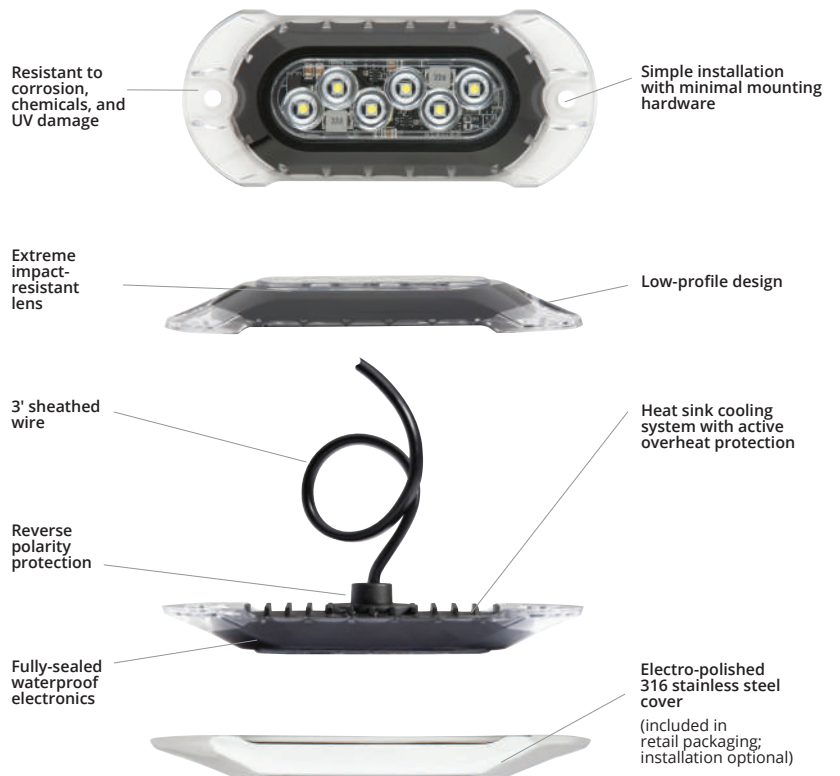

LIGHTARMOR™ LED Underwater Lights

NOTE: Bulk packaging **does not** include covers and aftermarket packaging does include covers.



Sapphire Blue
65UW03B



Tactical Green
65UW03G



Intense White
65UW03W

Description	Color	Fixture Lumens*	Current Draw at 13.6V	Current Draw at 24V	OEM Part #	Part #
High Performance (HP)						
4.0 HP - 4" length, 3 LED	Sapphire Blue	800	0.32	0.16	65UW03B-1	65UW03B-7
	Tactical Green		0.36	0.18	65UW03G-1	65UW03G-7
	Intense White		0.64	0.32	65UW03W-1	65UW03W-7
5.0 HP - 5" length, 6 LED	Sapphire Blue	1,350	0.66	0.33	65UW06B-1	65UW06B-7
	Tactical Green		0.71	0.36	65UW06G-1	65UW06G-7
	Intense White		1.26	0.63	65UW06W-1	65UW06W-7
6.0 HP - 6" length, 12 LED	Sapphire Blue	1,650	1.32	0.66	65UW12B-1	65UW12B-7
	Intense White		2.52	1.26	65UW12W-1	65UW12W-7
Extreme High Performance (HPX)						
4.0 HPX - 4" length, 3 LED	Sapphire Blue	1,350	0.64	0.32	—	66UW03B-7
5.0 HPX - 5" length, 6 LED	Sapphire Blue	2,750	1.30	0.65	66UW06B-1	66UW06B-7
	Tactical Green		1.40	0.70	66UW06G-1	—
	Intense White		2.46	1.23	66UW06W-1	—
6.0 HPX - 6" length, 12 LED	Sapphire Blue	5,000	2.59	1.30	66UW12B-1	66UW12B-7
	Intense White		4.50	2.25	—	66UW12W-7
Optional Covers - For OEM only (Aftermarket packaged product includes 316 Stainless Steel Cover)						
4.0 HP/HPX Cover	Stainless Steel				65UW03CVSS-1	—
5.0 HP/HPX Cover	Stainless Steel				65UW06CVSS-1	—
6.0 HP/HPX Cover	Stainless Steel				65UW12CVSS-1	—

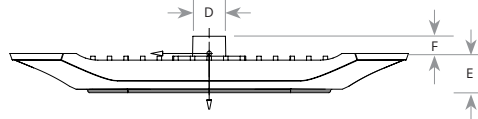
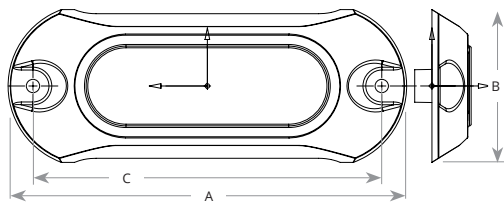

Dimensions

Model	Length (A)	Width (B)	Distance Between Mounting Holes (C)	Diameter of Wiring Hold (D)	Installed Product Height (E)	Wire Colar Depth (F)
4.0 HP	4.00"	2.15"	3.25"	.56"	.56"	.30"
4.0 HPX	4.00"	2.15"	3.25"	.56"	.56"	.30"
5.0 HP	5.00"	2.15"	4.25"	.56"	.56"	.30"
5.0 HPX	5.00"	2.15"	4.25"	.56"	.56"	.30"
6.0 HP	6.00"	2.35"	5.25"	.56"	.56"	.30"
6.0 HPX	6.00"	2.35"	5.25"	.56"	.56"	.30"

LED Underwater Lights, 3-Inch Series

Lights are 3/4" wide and are perfect for surface mounting on rails, transoms, and swim platforms. These LED lights exceed the output of comparable halogen lights, while using 20% of the power. Lights stay cool to the touch and eliminate the burn hazard that halogen lighting can present. Fully potted electronics and stainless steel housing allow for interior and exterior mounting – even underwater! Rated for 50,000+ hours of life.

- 1.5 watts at 12V DC



6343

Description	LED Color	OEM Part #	Part #
Horizontal Mount	White	—	6343SS7
Vertical Mount	White	6344SS1	—

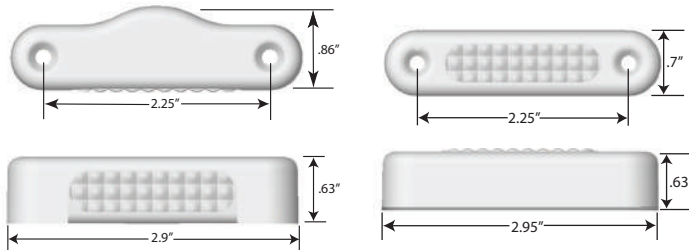

LED Utility Lights

LED Round Interior / Exterior Lights

These LED lights exceed the output of comparable halogen lights while using 20% of the power. Lights stay cool to the touch and eliminate the burn hazard that halogen lighting can present. Fully potted electronics and stainless steel housing allow for interior and exterior mounting. Rated for 50,000+ hours of life. Additional LED colors and bezel finishes are available upon request. For 12V DC systems

- Easy installation with minimal intrusion

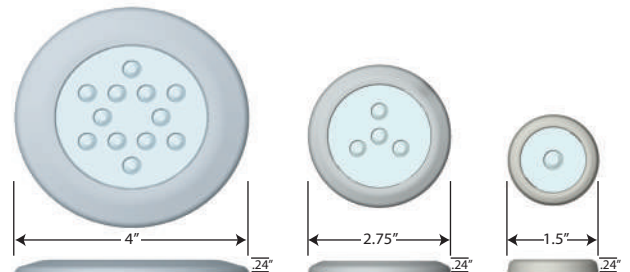

6340SS

6341SS

6320B

6320W

6342

Description	LED Color	OEM Part #	Part #
4" Round Interior Light, 3 Watts @ 12V DC			
Stainless Steel Bezel	Warm White + Red	6348SS1	—
2.75" Round Interior Light, 1.8 Watts @ 12V DC			
Stainless Steel Bezel White	Warm White	6346SS1	—
Black Plastic Bezel	Amber	6321B1	—
White Plastic Bezel	White	6320W1	6320W7
	Blue	6323W1	6323W7
1.5" Round Courtesy Light, 1.1 Watts @ 12V DC			
Stainless Steel Bezel	White	6342SS1	6342SS7

LED Mini Courtesy Lights

Attwood's 1" Mini LED Courtesy Lights offer excellent performance in an affordable package. Designed to be installed with just a hole saw, the Mini's rubber grommet eliminates fasteners and allows for quick and easy installation. Comes with fully sealed electronics; performs in almost any interior or exterior application.

- Compact
- Water-and shock-resistant
- 50,000 hours of life

Description	Color	OEM Part #	Part #
Rubber Grommet, Black	White	6317-1	—
	Blue	6319-1	—



6317

LED Micro Lights

Industry leading light output in an extremely compact package. With electropolished stainless steel covers and fully sealed electronics. Attwood Micro Lights perform through the harshest conditions. Can be used in rod storage boxes without risk of water damage, under hardtops, or even mounted to rails.

- .66 watts at 12V DC

Description	Color	OEM Part #	Part #
Stainless Steel Bezel, Vertical Mount	White	6350W1	6350W7
	Blue	6350B1	6350B7
Stainless Steel Bezel, Horizontal Mount	White	6351W1	—
	Blue	6351B1	—
	Green	6351G1	—



6350



6351

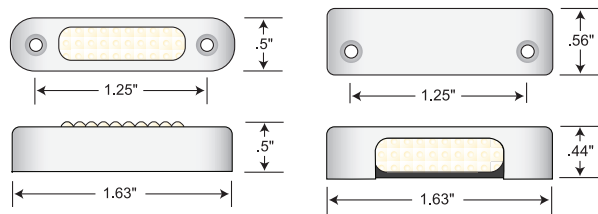

LED Utility Lights

These versatile, surface-mount LED Utility Lights put bright light where you need it.

- Water-resistant
- 12V DC
- Less than 1 Amp draw

Description	OEM Part #	Part #
4", 6 white LED's	—	6355W7
6", 12 white LED's	—	6354W7
8", 18 white LED's	—	6353W7



6353W7



6354W7



6355W7

Lighting Accessories & Replacements

Pole Light Storage Clips

New design holds larger (3/4") diameter anti-glare pole lights. Resilient plastic clip holds standard 3/4" diameter poles. Ideal for storing and protecting plug-in pole lights when mounted in engine wells or lockers. Installs with one #8 fastener.

Dimensions	Description	OEM Part #	Part #
2" L x 1-1/2" H	Black	7571-1	7571L7



7571



FUEL

Portable Fuel Tanks



87

Attwood fuel tanks are tested to meet EPA, CARB, and ABYC requirements. The tanks have industry leading fuel flow performance and are designed and manufactured for safety and durability.

Portable Fuel Components



88

Tank to engine solutions providing uncompromising reliability and durability. These unique components set the standard in performance, safety, and value.

Fuel Tanks & Hose Fittings



92

Attwood offers a variety of fuel tank and hose fittings that are suitable for use with leaded, unleaded, ethanol blended and alcohol-blended fuels.

Integrated Fuel Components



97

Attwood's integrated fuel components are designed for an industry-leading combination of safety, ease of use, and refueling performance. Engineered and tested for optimal vessel performance.

Fuel Accessories



103

Reliable portable and integrated fuel system solutions for your fuel needs.

Portable Fuel Components, International



106

International portable fuel components are manufactured using advanced technology, producing high-quality products.

Integrated Fuel Components, International



107

International integrated fuel components are uniquely designed and engineered for extreme strength for your boat's fuel system.



Portable Fuel Systems Overview

EPA Certified / CARB Approved

Your Comprehensive Tank-to-Engine Solution

As a result of EPA regulations to reduce evaporative emissions, portable fuel systems are now manufactured to prevent fuel vapor from escaping into the atmosphere. These EPA compliant systems are sealed and unable to vent as in the past, causing pressure build up in the tank that rarely occurred prior to these regulations.

In addition, each component within the system adds potential restriction to fuel flow. As fuel restriction levels rise, engine performance is affected. In some cases, complete failure can occur.

Attwood's EPA Certified Portable Fuel System components are designed specifically to handle the problems caused by pressure build-up and fuel restriction inherent in today's closed EPA compliant systems.

With Attwood's systems, your engine will perform properly and valuable fuel will stay in the tank where it belongs. Attwood's systems were developed, with leading engine manufacturers, to ensure optimum, reliable performance on the water. That's the performance you'd expect from the industry leader in marine fuel systems and accessories.

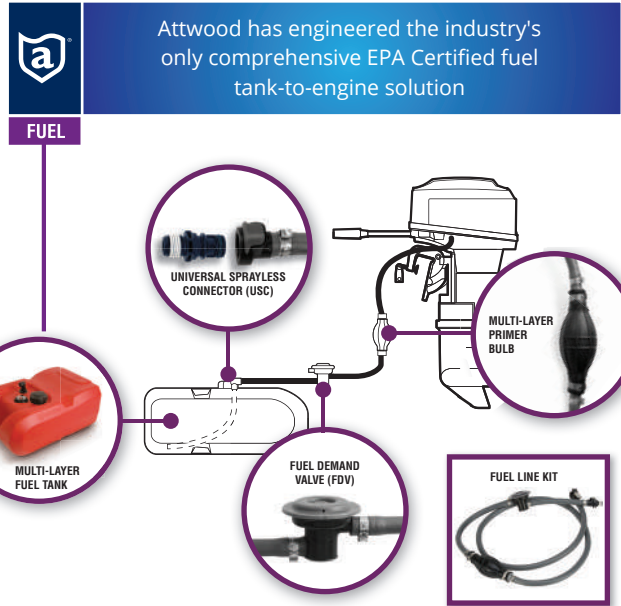

EPA Certified Portable Fuel Tanks

Attwood fuel tanks are tested to meet EPA and CARB requirements and ABYC standards for portable marine tanks. The tanks have industry leading fuel flow performance and are designed and manufactured for safety and durability in harsh marine conditions.

- Proven automotive-grade multi-layer construction withstands the pressure build-up associated with closed systems
- Engineered for harsh conditions, temperature extremes and abuse
- Injection molded interfaces eliminate leaks
- Automatic vacuum valve in cap eliminates the need for manual vent
- Compatible with 1/4" NPT fuel fittings
- Built-in 5% ullage for fuel expansion

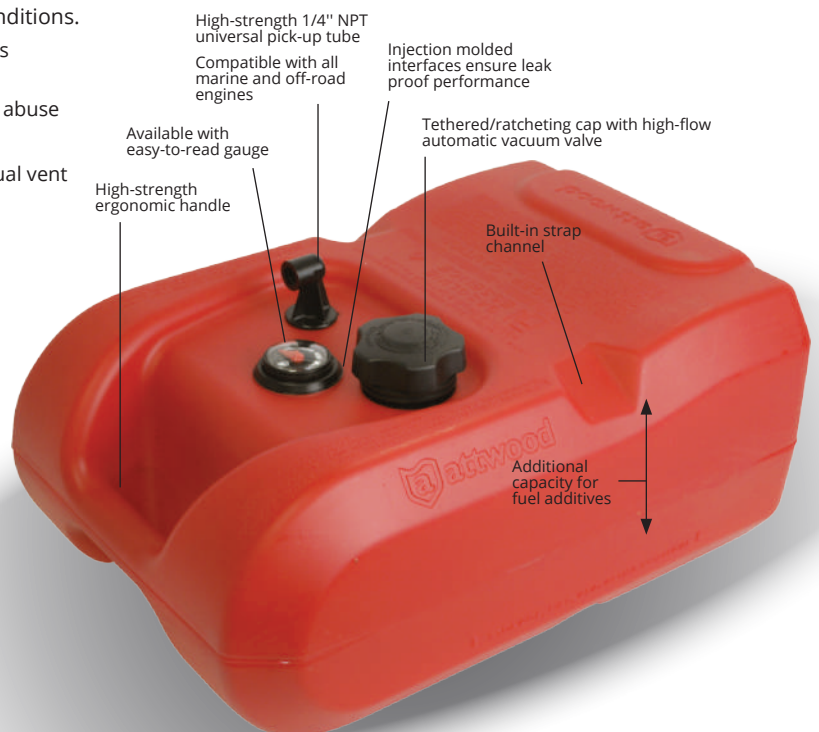
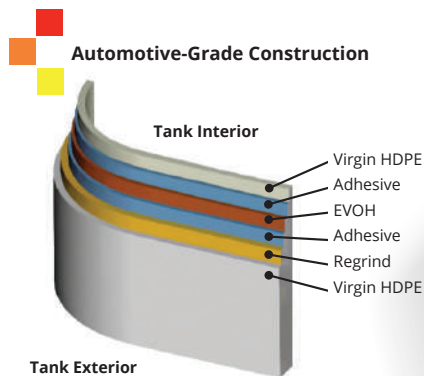

Portable Fuel Tanks

EPA Certified / CARB Approved

EPA Certified multi-layer tank with industry leading fuel flow performance. Designed around the EPA and California Air Resources Board (CARB) regulations. Features an ergonomic design, an optional gauge and a tethered self sealing cap with audible click.

- Automatic Vacuum Valve ensures proper fuel flow and eliminates the need for manual vent and operator adjustment
- Low-permeation tank virtually eliminates fuel evaporation and fuel loss
- Compatible with 1/4" NPT fuel fittings
- Ethanol and alcohol compatible
- EPA & CARB Certified



3-Gallon Fuel Tanks

EPA/CARB COMPLIANT 3-gallon fuel tank is perfect for use with small outboards.

Description	Dimensions			Part #
	Length	Width	Height	
3-gallon, without gauge	16.6"	11.45"	7.3"	8803LP2
3-gallon, with gauge	16.6"	11.45"	7.3"	8803LPG2
3-gallon, without gauge, single-pack	16.6"	11.45"	7.3"	8803LP2S
3-gallon, with gauge, single-pack	16.6"	11.45"	7.3"	8803LPG2S

6-Gallon Fuel Tanks

EPA/CARB COMPLIANT 6-gallon fuel tank adapts to virtually any outboard engine.

Description	Dimensions			Part #
	Length	Width	Height	
6-gallon, without gauge	19.82"	13.50"	9.16"	8806LP2
6-gallon, with gauge	19.82"	13.50"	9.16"	8806LPG2
6-gallon, without gauge, single-pack	19.82"	13.50"	9.16"	8806LP2S
6-gallon, with gauge, single-pack	19.82"	13.50"	9.16"	8806LPG2S

12-Gallon Fuel Tanks

EPA/CARB COMPLIANT 12-gallon fuel tank is ideal for pontoon boats where more fuel capacity is needed.

Description	Dimensions			Part #
	Length	Width	Height	
12-gallon, without gauge	22.75"	14.25"	14.47"	8812LP2
12-gallon, with gauge	22.75"	14.25"	14.47"	8812LPG2
12-gallon, low-profile, without gauge*	24.00"	18.00"	11.61"	8812LLP2
12-gallon, low-profile, with gauge*	24.00"	18.00"	11.61"	8812LLPG2



Attwood fuel tank gauges are easy-to-read, accurate and durable.



8803LP



8803LPG



8806LP



8806LPG



8812LP



8812LPG



8812LLPG

Portable Fuel Components

EPA Certified / CARB Approved

Primer Bulbs

EPA Certified / CARB Approved

Attwood's multi-layer primer bulbs provide the absolute best combination of performance, reliability, safety and compliance to ensure your experience on the water is easier and safer to enjoy. Our exclusive three-layer design resists collapsing and hardening and ensures high output in temperatures ranging from 18°F to 122°F. Includes high-efficiency check valves with Viton O-rings for improved sealing. Assembled with the same components as Mercury and Quicksilver.

- Exclusive three-layer construction provides the best spring-back during priming and excellent resistance to collapse during high-flow engine operation
- Premium materials give the absolute best combination of performance and reliability:
 - No cracking/hardening over time
 - Low permeation for EPA/CARB compliance
 - Excellent priming in extreme cold and hot environments
 - Zero chance of material delamination as seen by some competitor's products
- New high-performance check valve O-rings provide 30% improved priming while keeping optimized flow during engine use (20 to 35% better than spring-loaded designs)
- EPA and CARB certified



Description	OEM Part #	Part #
3/8" I.D. Hose	—	93038LP7
5/16" I.D. Hose	—	93516LP7
1/4" I.D. Hose	—	93014LP7

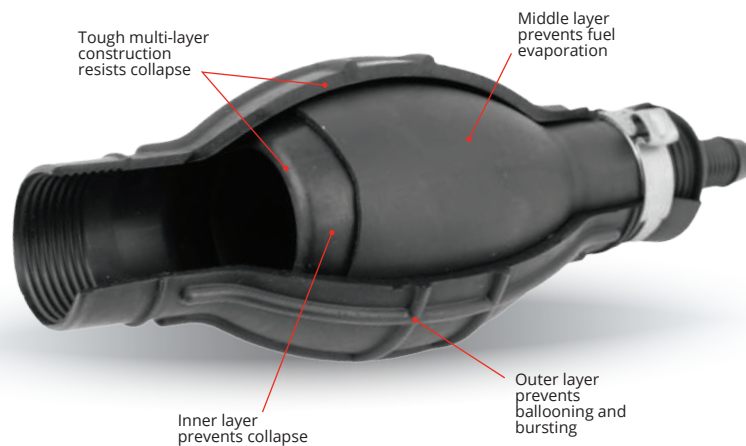

New, high-performance check valves with O-Rings provide 30% faster priming during start-up and high flow when running (20 to 35% better than spring-loaded designs)

Fuel Demand Valve EPA Certified / CARB Approved

Attwood's exclusive Fuel Demand Valve eliminates engine flooding and spillage by preventing pressurized fuel from reaching the engine. The valve ensures that fuel is supplied to the engine only when demanded during start up or engine operation. Designed in partnership with OEM engine manufacturers, Attwood's Fuel Demand Valve is compatible with all OEM engine brands.

- Prevents engine flooding and fuel spillage due to pressurized fuel
- Allows only the amount of fuel requested by the engine and prevents a pressurized "slug" of fuel from reaching engine
- Made of high-strength composite material designed to withstand the harsh marine environment
- Compatible with 3/8" and 5/16" fuel hose
- Installs between the fuel tank and the primer bulb
- Low vacuum restriction helps ensure proper engine function during startup and engine operation (less than 2kPa at 125 liters/hour)
- Built-in manual override
- Compatible with Ethanol blended fuels



Specifications

Operating Temp	Storage Temp	Operating Input Pressure	Flow Performance	Hose Size	Manual Override
-20 °C to 80 °C (-4 °F to 176 °F)	-40 °C to 80 °C (-40 °F to 176 °F)	138 kPa (20 psi) protected for 276 kPa (40 psi) psi pressure spike	125 L/H (33 GPH) at <2 kPa (10" gasoline)	8 mm - 10 mm (5/16" - 3/8")	Yes

Description	OEM Part #	Part #
In-Line Fuel Demand Valve	8M0044687	9300FDV7

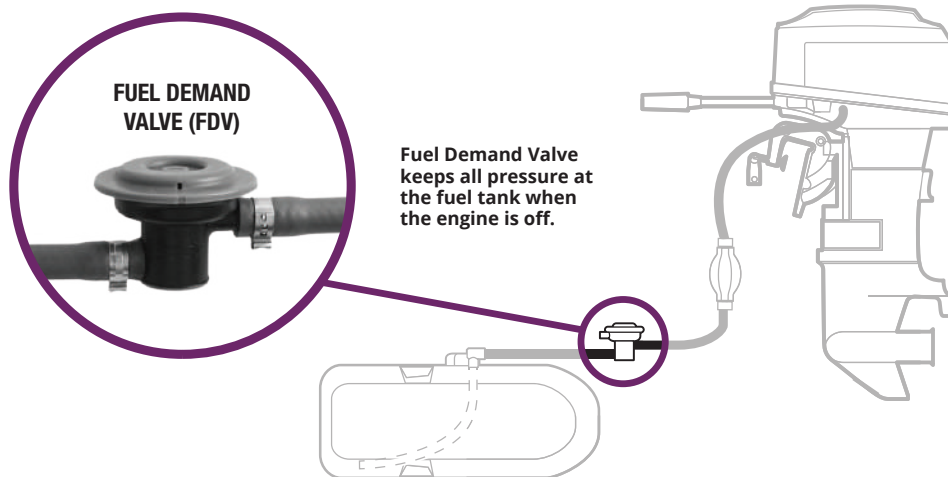

Universal Sprayless Connector (USC) EPA Certified / CARB Approved

The Universal Sprayless Connector is a safe way to eliminate the spraying of fuel when connecting and disconnecting pressurized fuel hoses during fueling or maintenance.

- Attwood's Universal Sprayless Connector replaces traditional tank fittings and eliminates spray when connecting or disconnecting fuel fittings
- High strength body engineered to withstand the harsh marine environment
- Female hose and Male hose fittings compatible with 3/8" and 5/16" fuel lines
- Male tank fitting has pre-applied fuel-grade thread sealant to prevent fuel leaks and fits all standard 1/4" NPT fittings
- Male and female connectors include check valves that automatically close upon disconnecting
- High fuel flow fitting (less than .25kPa restriction at 50 liters/hour)
- Compatible with Ethanol blended fuels
- Compatible with all OEM brand engines

Description	OEM Part #	Part #
Male and Female w/Thread Sealant	—	8838US6
Hose Female, 5/16"-3/8"	001008200	8838HF6
Tank Male, 1/4" NPT w/Thread Sealant	001008199	8838TM6
Hose Male, 5/16"-3/8"	001011094	8838HM6

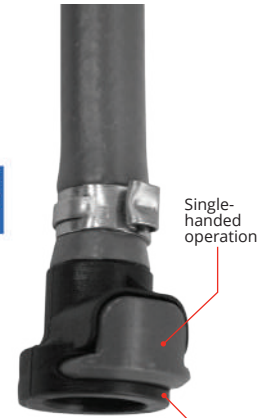

Single-handed operation



PRE-APPLIED FUEL-COMPATIBLE THREAD SEALANT

Tank fitting included with all EPA kits

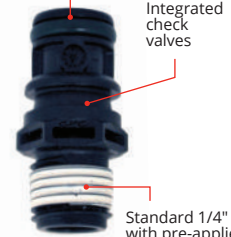

Integrated check valves

Standard 1/4" NPT with pre-applied thread sealant



8838HF6



8838TM6



8838US6



8838HM6

Fuel Line Kits EPA Certified / CARB Approved

Attwood's low-permeation Fuel Line Kits set the standard in performance, safety and value. They include Attwood's award-winning Universal Sprayless Connector (hose and tank fittings with thread sealant), multi-layer low-permeation Primer Bulb and low-permeation fuel line. Fuel Demand Valve is optional.



- Multi-Layer Primer Bulb with new High-Performance Check Valve & O-Ring: Provides 30% faster priming during start-up and 20-35% higher running flow than competitive designs
- Ethanol Resistant Fuel Line: Eliminates inner-layer delamination seen by others
Fuel Demand Valve (if equipped): Prevents engine flooding by restricting pressurized fuel from reaching the engine
- Universal Sprayless Tank Fitting: Enables a safe, gas-free experience at every connection

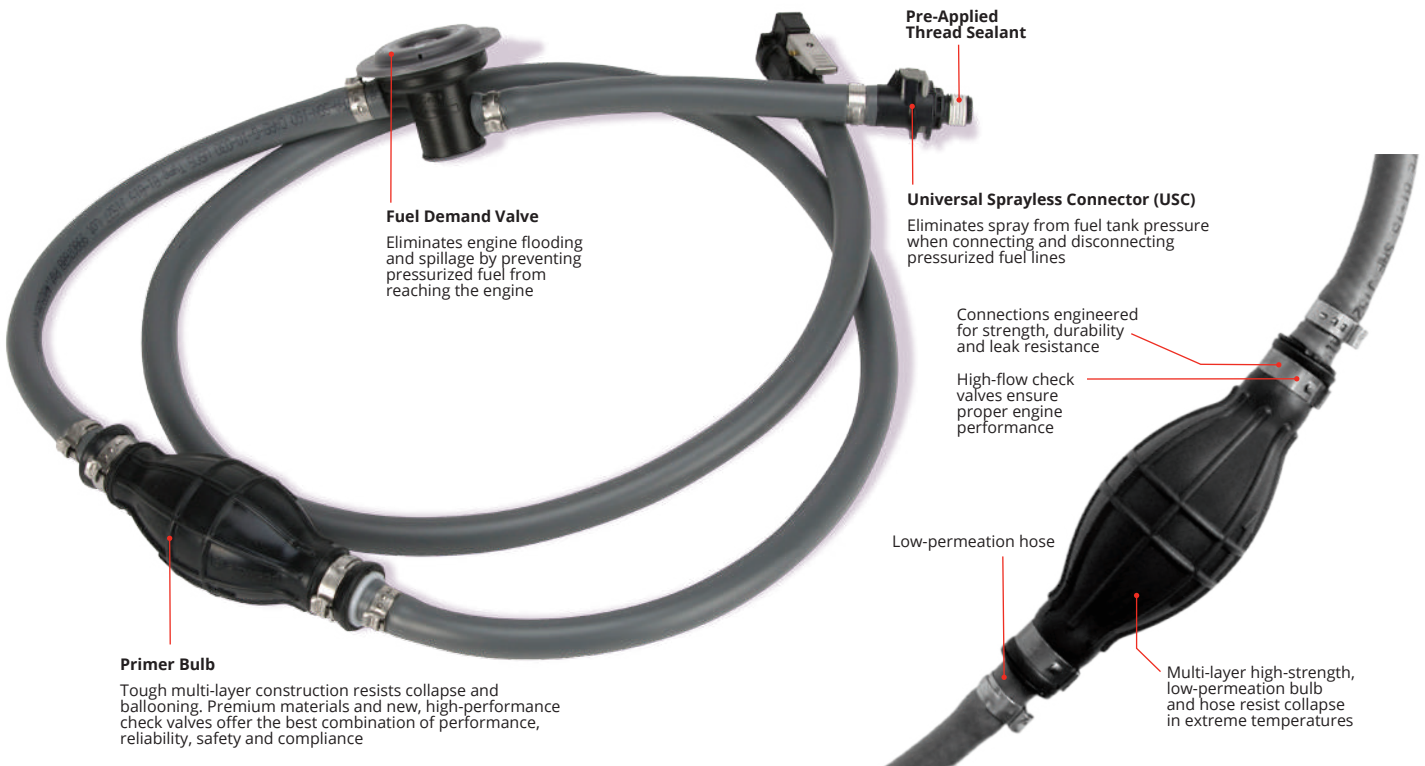

End Fitting								
Engine	Length	Diameter	Includes Tank Fitting	Includes Hose Fitting Tank End	Includes Hose Fitting Engine End	Primer Bulb	Fuel Demand Valve	Part #
Universal Brand Engines and Tanks								
Universal	6'	5/16"	None	None	None	Multi-layer / Low-Permeation	No	951606ULP7
Universal	6'	3/8"	8838TM6	8838HF6	None	Multi-layer / Low-Permeation	No	93806UUS7
Universal	6'	3/8"	8838TM6	8838HF6	None	Multi-layer / Low-Permeation	Yes	93806UUSD7
Universal	12'	3/8"	8838TM6	8838HF6	None	Multi-layer / Low-Permeation	No	93812UUS7
Universal	12'	3/8"	8838TM6	8838HF6	None	Multi-layer / Low-Permeation	Yes	93812UUSD7
Universal	6'	3/8"	None	None	None	Multi-layer / Low-Permeation	No	93806ULP7
Universal	6'	3/8"	None	None	None	Multi-layer / Low-Permeation	Yes	93806UFDV7
Universal	12'	3/8"	None	None	None	Multi-layer / Low-Permeation	No	93812ULP7
Mercury Brand Engines and Tanks								
Mercury	6'	3/8"	8838TM6	8838HF6	8896LP6	Multi-layer / Low-Permeation	No	93806MUS7
Mercury	6'	3/8"	8838TM6	8838HF6	8896LP6	Multi-layer / Low-Permeation	Yes	93806MUSD7
Mercury Pre-1998	6'	3/8"	8838TM6	8838HF6	8893-6	Multi-layer / Low-Permeation	No	93806AUS7
Johnson Brand Engines and Tanks								
Johnson / Evinrude	6'	3/8"	8838TM6	8838HF6	8889LP6	Multi-layer / Low-Permeation	No	93806EUS7
Johnson / Evinrude	6'	3/8"	8838TM6	8838HF6	8889LP6	Multi-layer / Low-Permeation	Yes	93806EUSD7
Johnson / Evinrude	6'	3/8"	None	8889LP6	8889LP6	Multi-layer / Low-Permeation	No	93806ELP7
Yamaha Brand Engines and Tanks								
Yamaha	6'	3/8"	None	8896LP6	8896LP6	Multi-layer / Low-Permeation	No	93806YLP7
Yamaha	6'	3/8"	8838TM6	8838HF6	8896LP6	Multi-layer / Low-Permeation	No	93806YUS7
Honda Brand Engines and Tanks								
Honda	6'	3/8"	8838TM6	8838HF6	8900-6	Multi-layer / Low-Permeation	No	93806HUS7

Fuel Tank & Hose Fittings



Attwood fuel tank fittings and hose fittings are suitable for use with leaded, unleaded, ethanol blended and alcohol-blended fuels. Unless otherwise specified, threaded fittings have 1/4" male NPT threads; barbed fittings fit 3/8" I.D. hose. Clamps are not included. Use thread sealant on all threads.

Fitting	Description	Material Construction	Mates to	Notes	Part #
Mercury/Mariner					
1/4" NPT Thread	Tank Male	Brass	8890LP6	Mercury Tank Fitting	8873-6
3/8" Barb	Hose Female	Acetal	8873-6	Mercury Tank Fitting	8890LP6
3/8" Barb	Hose Female	Acetal		Mercury Engine End	8896LP6
1/4" NPT Thread	Twist-lock Tank Female	Nylon	14532-6	w/90° Elbow, 2-Piece	8882-6
1/4" NPT Thread	Twist-lock Tank Female	Die-cast Zinc	14532-6	w/90° Elbow, 1-Piece	14530-6
3/8" Barb	Twist-lock Hose Male	Die-cast Zinc	8882-6, 14530-6		14532-6
Johnson/Envinrude/OMC					
1/4" NPT Thread	Tank Male	Brass	8889LP6, 88FHE516-6		8883-6
5/16" Barb	Hose Female	Acetal	8883-6	Tank or Engine End	88FHE516-6
3/8" Barb	Hose Female	Acetal	8883-6	Tank or Engine End	8889LP6
Yamaha					
1/4" NPT Thread	Tank Male	Brass	8896LP6, 88FHY516-6		8897-6
5/16" Barb	Hose Female	Acetal	8897-6	Tank or Engine End	88FHY516-6
3/8" Barb	Hose Female	Acetal	8897-6	Tank or Engine End	8896LP6
Honda					
1/4" NPT Thread	Tank Male	Chrome-plated Brass	8902-6	90HP+ (Large Bore)	8901-6
3/8" Barb	Hose Female	Chrome-plated Brass	8901-6	90HP+ (Large Bore)	8902-6
3/8" Barb	Hose Female	Acetal		Engine End	8900-6
Chrysler					
1/4" NPT Thread	Tank Male	Chrome-plated Brass	8884-6		14509-6
3/8" Barb	Hose Female	Chrome-plated Brass	14509-6		8884-6
Suzuki					
1/4" NPT Thread	Tank Male	Chrome-plated Brass	88FTS014-6	Under 75HP (Small Bore)	14509-6
3/8" Barb	Hose Female	Chrome-plated Brass	14509-6	Under 75HP (Small Bore)	88FTS014-6
Universal					
1/4" NPT x 1/4" NPTF	90° Elbow	Brass			8887-6
1/4" NPT x 5/16" Barb	Male Thread, Hose Barb	Brass			88FBM101-6
1/4" NPT x 3/8" Barb	Male Thread, Hose Barb	Brass			14540-6
3/8" NPT x 3/8" Barb	Male Thread, Hose Barb	Aluminum			88FBMA102-6
1/4" NPT x 3/8" Barb	Male Thread, Anti-Siphon Valve	Aluminum			88FAS014-6
3/8" NPT x 3/8" Barb	Male Thread, Anti-Siphon Valve	Aluminum			88FAS038-6
3/8" Hose Mender	In-line Fuel Splice Kit	Brass		Includes (2) Stainless Steel Hose Clamps	11822-6

Fuel Tank Shut Off Valve

Description	OEM Part #	Part #
Brass: 1/4" NPT x 1/4" NPTF	—	88FV200-6

88FV200



Mercury



8838US6

8873

8890LP

8896LP

8882

14530

14534

14532

Johnson



8883

88FHE516

8889LP

Yamaha



8897

88FHY516

8896LP

Honda



8901

8902

8900

Chrysler



14509

8884

Suzuki



14509

88FTS014

Universal



8887

88FBM101

14540

88FBMA102

88FAS014

88FAS038

11822 11823 11824

Always use thread sealant when assembling threaded fittings.

VAPORTEC

Integrated Fuel Systems Overview

EPA Certified / CARB Approved

Carbon Canister Fuel Systems

The VaporTec fuel pressure management system ensures that a boat's fuel system constantly maintains proper vapor pressure in all situations. This eliminates any unintended excess pressure which can seriously damage a boat or engine.

Carbon canister systems utilize an engineered charcoal canister to reduce hydrocarbons entering the atmosphere. Other

components of a carbon canister system are designed to ensure the tank fills to the proper level every time without spit-back or well-back. All Attwood carbon canister systems are designed to ensure liquid fuel or water does not reach the canister and are compatible with Jerry Can and marine nozzle refueling.

Direct Fill Carbon Canister Fuel System

- Single 1 psi overpressure relief safety valve built into the caps
- Automatic nozzle shutoff 4-10 gpm
- Anti-backout feature prevents accidental removal
- Reduced number of system components
- Direct Fill system is well-suited for applications such as pontoon "transom" designs

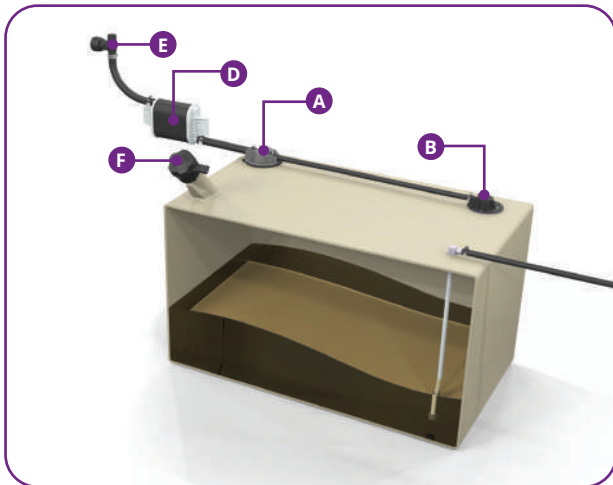

- A** Fill Limit Vent Valve
- B** Grade Valve
- C** Inlet Control Valve
- D** Carbon Canister

Remote Fill Carbon Canister Fuel System

- Dual 1 psi overpressure relief safety valves built into the deck fill caps
- Automatic nozzle shutoff 4-18 gpm

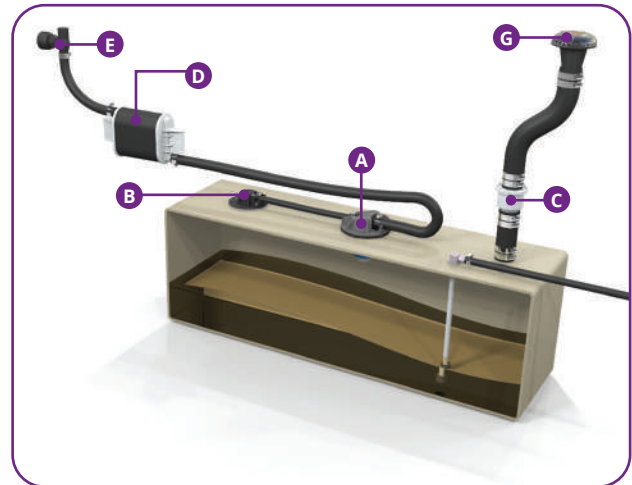

- E** P-Trap
- F** Direct Fill Unit
- G** Deck Fill Unit

Pressure Relief Fuel Systems

The VaporTec fuel pressure management system ensures that a boat's fuel system constantly maintains proper vapor pressure in all situations. This eliminates any unintended excess pressure which can seriously damage a boat or engine.

Pressure relief systems are designed with automatic diurnal emission control and overpressure relief safety valves built into the cap of the fill. The overpressure relief safety valves are

engineered to release pressure above 1 psi. The high-flow vacuum valves allow fresh air to enter the fuel tank to replace the fuel being consumed by the engine. Other components of a pressure relief system are designed to ensure the tank fills to the proper level every time without spit-back or well-back. All Attwood pressure relief systems are designed to ensure water does not enter the fuel tank and are compatible with Jerry Can and marine nozzle refueling.

Direct Fill Pressure Relief Fuel System

- Dual 1 psi diurnal emission control and overpressure relief safety valves built into the cap
- Dual high-flow vacuum valves ensure maximum make-up air flow with minimum vacuum restriction
- Automatic nozzle shutoff 4-10 gpm
- Anti-backout feature prevents accidental removal
- Reduced number of system components
- Direct Fill system is well-suited for applications such as pontoon "transom" designs

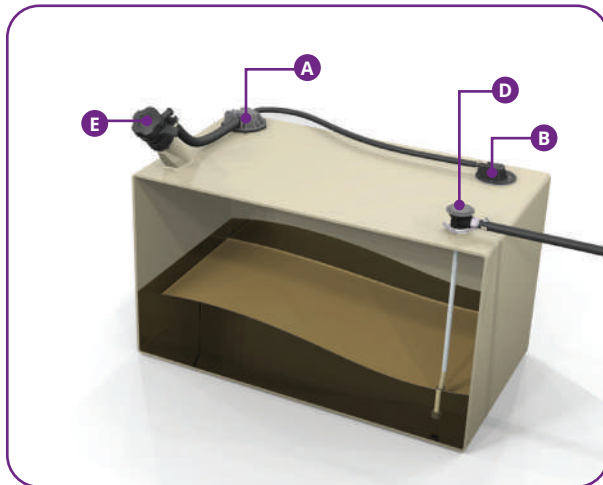

- **A** Fill Limit Vent Valve
- **B** Grade Valve
- **C** Inlet Control Valve

Remote Fill Pressure Relief Fuel System

- Dual 1 psi diurnal emission control and overpressure relief safety valves built into the cap
- Triple high-flow vacuum valves ensure maximum make-up air flow (compatible with high HP applications)
- Automatic nozzle shutoff 4-18 gpm

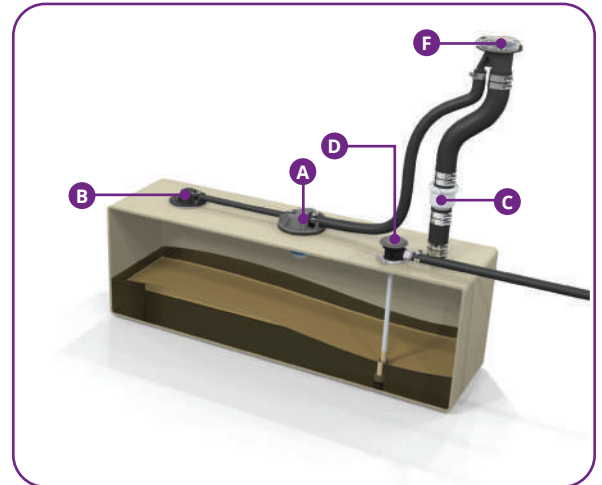

- **D** Fuel Demand Valve
- **E** Direct Fill Unit (Includes Inlet Control Valve)
- **F** Deck Fill Unit

Diurnal Fuel System Components

EPA Certified / CARB Approved



		Carbon Canister Direct Fill	Carbon Canister Remote Fill	Pressure Relief Direct Fill	Pressure Relief Remote Fill
Carbon Canister Deck Fills			See Page 97		
Carbon Canister Direct Fill		See Page 98			
Pressure Relief Deck Fills					See Page 100
Pressure Relief Direct Fill				See Page 101	
Inlet Control Valve			See Page 102		See Page 102
Fill Limit Vent Valve		See Page 102	See Page 102	See Page 102	See Page 102
Grade Valve		See Page 102	See Page 102	See Page 102	See Page 102
Carbon Canister		See Page 99	See Page 99		
Integrated Fuel Demand Valve				See Page 100	See Page 100
P-Trap		See Page 98	See Page 98		

Fuel Systems Components

EPA Certified

Deck Fills for Carbon Canister Systems

EPA Certified

- Essential component of VaporTec and SecureStop
- Dual 1 psi overpressure relief safety valves built into the cap
- Automatic nozzle shutoff 4-18 gpm
- Hinged audible click cap meets EPA requirements
- Meets CARB 13 CCR 2235 and ISO 13331 nozzle mating and retention standards
- Designed and tested to prevent water from entering the fuel system
- Compatible with Ethanol blended fuels
- Fits 1-1/2" fill hose



Y1 Flat cap

Scalloped cap

Description	Body	Cap Material	Cap Design	OEM Part #	Part #
Deck Fill for Carbon Canister	Straight	Black Plastic	Scalloped	99DFCCSB1	—
		White Plastic	Scalloped	99DFCCSW1	—
		Chrome	Scalloped	99DFCCSZ1	99DFCCSZ1S
		Stainless Steel	Scalloped	99DFCCS1	99DFCCS1S
		Stainless Steel	Y1 Flat	99DFCCSSY1-1	—
	Angled	Black Plastic	Scalloped	99DFCCAB1	99DFCCAB1S
		White Plastic	Scalloped	99DFCCAW1	—
		Chrome	Scalloped	99DFCCA1	99DFCCA1S
		Stainless Steel	Scalloped	99DFCCAS1	99DFCCAS1S
		Stainless Steel	Y1 Flat	99DFCCASY1-1	—



99DFCCSSY1-1



99DFCCAB1



99DFCCAW1

Low Profile Deck Fills for Carbon Canister Systems

EPA Certified

- Essential component of VaporTec and SecureStop
- Stainless steel construction
- Exclusive overpressure relief valve that is protected by a waterproof screen to eliminate the possibility of water entering the system
- 4-18 gpm refueling when used in an Attwood fuel system
- Flip-up tethered cap for ease of use
- Red dots indicate visual closure for EPA standards
- Compatible with Ethanol blended fuels
- Fits 1-1/2" fill hose

Description	Body	OEM Part #	Part #
Low Profile Deck Fill for Carbon Canister	Straight	99DFCCLPSS1	—
	Angled	99DFCCLPAS1	—



99DFCCLPSS1



99DFCCLPAS1

Direct Fill for Carbon Canister Systems EPA Certified

- Essential component of VaporTec and SecureStop
- Single 1 psi overpressure relief safety valve built into cap
- Anti-backout feature prevents accidental removal
- Automatic nozzle shutoff 4-10 gpm
- Reduced number of components in the system
- Includes ratcheting tethered cap
- Compatible with Attwood's carbon canister architecture
- Meets CARB 13 CCR 2235 and ISO 13331 nozzle mating and retention standards
- Compatible with Ethanol blended fuels
- Fits 1-1/2" fill hose



99TDF100-1

Description	OEM Part #	Part #
Carbon Canister Direct Fill	99TDF100-1	—

90° P-Trap Fuel Tank Vents

These vents help prevent water from entering the fuel tank, yet allow air to vent freely, during normal sea conditions and washdowns. This eliminates the need for an anti-siphon loop in the vent hose. For 5/8" I.D. hose. Meets ABYC standard.

The arrows in this cross-section show the baffled route that water would have to travel in order to reach the fuel vent hose. Compatible with Ethanol blended fuels.

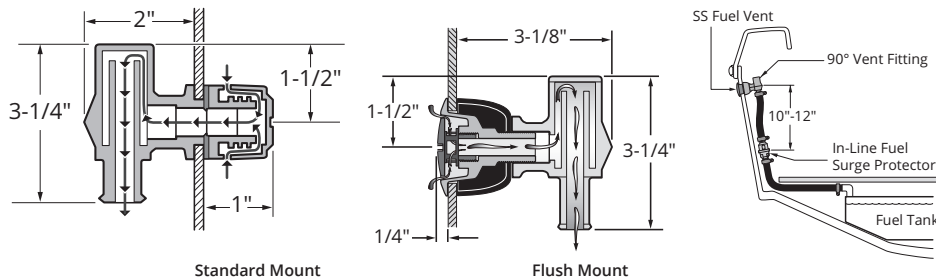

1670



1674

Description	Maximum Hull Thickness	Installation Hole Size	Style	OEM Part #	Part #
Standard Mount - 5/8" I.D. Hose	9/16"	3/4"	Black with black vent head	1670-1	1670-3
			Black with stainless steel trim cover	66419-1	66419-3
Replacement covers for Standard Mount	—	—	For 1670	911526-1	—
			For 66419	911528-1	—
Flush Mount - 5/8" I.D. Hose	1"	1-3/8"	Black with stainless steel vent head	1674-1	1674-6
Replacement Spacer for Flush Mount	1/4" - 1/2"	—	For 1674	911507-1	—
	1/2" - 3/4"	—	For 1674	911508-1	—

Carbon Canisters EPA Certified / CARB Approved

- Fits 5/8" vent hose
- Can be mounted in any orientation using brackets provided
- Compatible with Ethanol blended fuels
- Low permeation shell reduces overall system emissions
- Carbon Canister for Engine Compartment models feature a pre-installed composite heat-shield for easy installation

Description	EPA Rating		CARB Rating		L x W x H	OEM Part #	Part #
	Trailerable Vessel Capacity	Non-Trailerable Vessel Capacity	Trailerable Vessel Capacity	Non-Trailerable Vessel Capacity			
Sub Compact							
Brackets OEM Installed	28 Gal.	44 Gal.	22.4 Gal.	44 Gal.	11.6" x 5.04" x 4.01"	99CC035-1	—
Compact							
Brackets OEM Installed	70 Gal.	110 Gal.	56 Gal.	110 Gal.	Refer to Horizontal/Vertical	99CC045-1	99CC045-1S
Brackets Pre-installed Horizontal Orientation	70 Gal.	110 Gal.	56 Gal.	110 Gal.	11.6" x 5.04" x 4.01"	99CC045H1	—
Brackets Pre-installed Vertical Orientation	70 Gal.	110 Gal.	56 Gal.	110 Gal.	10.48" x 3.05" x 5.50"	99CC045V1	—
Carbon Canister for Engine Compartment	70 Gal.	110 Gal.	56 Gal.	110 Gal.	11.68" x 4.08" x 5.68"	99CC045HSA1	—
Standard							
Brackets OEM Installed	220 Gal.	350 Gal.	176 Gal.	350 Gal.	Refer to Horizontal/Vertical	99CC085-1	99CC085-1S
Brackets Pre-installed Horizontal Orientation	220 Gal.	350 Gal.	176 Gal.	350 Gal.	17.22" x 5.04" x 4.01"	99CC085H1	—
Carbon Canister for Engine Compartment	220 Gal.	350 Gal.	176 Gal.	350 Gal.	17.74" x 4.08" x 5.68"	99CC085HSA1	99CC085HSA1S
Large Vessel							
Brackets OEM Installed	420 Gal.	660 Gal.	*N/A	*N/A	Refer to Horizontal/Vertical	99CC150-1	99CC150-1S

* CARB allows use of 2 canisters assembled in series to match/exceed needed capacity. Contact Attwood Customer Service for more information.



Deck Fills for Pressure Relief Systems

EPA Certified / CARB Approved

- Essential component of VaporTec and SecureStop
- Dual 1 psi diurnal emission control overpressure relief safety valves
- Triple high-flow vacuum valves ensure maximum make-up air flow with minimum vacuum restriction
- Designed and tested to prevent water from entering the fuel system
- Automatic nozzle shutoff 4–18 gpm
- Hinged audible click cap meets EPA requirements
- Meets CARB 13 CCR 2235 and ISO 13331 nozzle mating and retention standards
- Designed and tested to prevent water from entering the fuel system
- Compatible with Ethanol blended fuels
- Fits 1-1/2" fill hose and 5/8" vent hose



Y1 Flat cap



Scalloped cap



99DFPVSZ1



99DFPVASY1-1

Description	Body	Cap Material	Cap Design	OEM Part #	Part #
Deckfill for Pressure Relief System	Straight	Black Plastic	Scalloped	99DFPVSZ1	99DFPVSZ1
		Chrome	Scalloped	99DFPVSZ1	—
		Stainless Steel	Scalloped	99DFPVSZ1	99DFPVSZ1
		Stainless Steel	Y1 Flat	99DFPVSZ1-1	—
	Angled	Black Plastic	Scalloped	99DFPVAB1	99DFPVAB1S
		Chrome	Scalloped	99DFPVAB1	—
		Stainless Steel	Scalloped	99DFPVAS1	99DFPVAS1S
		Stainless Steel	Y1 Flat	99DFPVASY1-1	—

Fuel Demand Valve

The integrated fuel demand valve, used in conjunction with integrated fuel systems eliminates pressurized fuel from reaching fuel distribution lines and your engine and ensures that fuel is provided to the engine on demand rather than as a result of pressure in the tank. Additional features include:

- Compatible with Ethanol blended fuels
- Eliminates the need for rigid fuel distribution lines in pressure relief systems (per ABYC H-24.15.9)

Specifications

Operating Temp	Storage Temp	Operating Input Pressure	Flow Performance	Manual Override
-20° C to 80° C (-4° F to 176° F)	-40° C to 80° C (-40° F to 176° F)	138 kPa (20 psi) protected for 276 kPa (40 psi) psi pressure spike	200 L/H (53 GPH) at <2 kPa*	Yes

*Flow performance of 99IFDV00-1 with 1/2" Pick up tube and 99DVB02-1 Barb. Other factors such as fuel lift height, anti-siphon valve, fuel hose diameter and length and fuel filter will effect overall flow performance to engine.

Description	OEM Part #	Part #
Integrated Fuel Demand Valve (IFDV)	99IFDV00-1	—
Base for Aluminum Tank	99DVA02-1	—
Pick-Up Tube Barb with O-Ring 3/8"	99DVB01-1	—
Pick-Up Tube Barb with O-Ring 1/2"	99DVB02-1	—
IFDV Installation Clip	99DVC01-1	—
IFDV Plug Cap with Seal	99DVP03-1	—
Heat Shield	99IFDVHS1	—
Single Flange Base for Plastic Tank	99DVP05-1	—
Hex Compression Nut for 99DVP05-1	99DVP04-1	—
Aluminum Tank Attachment Kit‡	99IFDVKT-1	—

‡99IFDVKT-1 includes 99IFDV00-1, 99DVA02-1, 99DVB01-1, 99DVC01-1



99IFDV00

Direct Fill for Pressure Relief Systems EPA Certified / CARB Approved

- Essential component of VaporTec and SecureStop
- Dual high-flow vacuum valves ensure maximum make-up air flow with minimum vacuum restriction
- Dual 1 psi diurnal emission control and overpressure relief safety valves
- Anti-backout feature prevents accidental removal
- Automatic nozzle shutoff 4-10 gpm
- Reduced number of components in the system
- Includes ratcheting tethered cap
- Performs automatic shut-off function when used with an Attwood system
- EPA and CARB certified
- Meets CARB 13 CCR 2235 and ISO 13331 nozzle mating and retention standards
- Compatible with Ethanol blended fuels
- Fits 1-1/2" fill hose and 5/8" vent hose

Description	OEM Part #	Part #
Pressure Relief Direct Fill	99TDFPV100-1	—
Replacement Cap	99TDFPV110-1	—

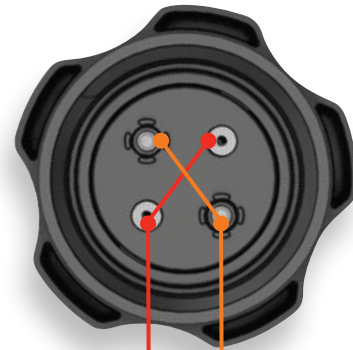

Dual 1 psi diurnal emission control and overpressure relief safety valves

Dual high-flow vacuum valves ensure maximum make-up air flow



Inlet Control Valve

EPA Certified

- Essential component of VaporTec and SecureStop
- Built-in overpressure relief compatibility
- Guaranteed 18 gallons per minute fuel flow during filling
- Compatible with 1-1/2" fill hose
- Compatible with Ethanol blended fuels
- Can be oriented between 0°–90° in line with fuel flow

Description	OEM Part #	Part #
Inlet Control Valve	99ICV000-1	—
ICV Heat Shield	99ICV000HS2	—



99ICV000

Fill Limit Vent Valves

- Essential component of VaporTec and SecureStop
- Sets the full level of fuel in the tank
- Prevents liquid fuel from reaching the carbon canister or vent system during vessel operation, trailering and storage
- Compatible with Ethanol blended fuels and plastic and aluminum tanks
- Passes all USCG CFR 33 and ABYC H-24 fire test requirements and CARB and EPA requirements
- Integrated high-performance gasket included
- Assembly Guide aligns the FLVV and gasket with tank for faster installation

Description	Shut-off Height	OEM Part #	Part #
Fill Limit Vent Valve with GRV Communication	0.8"	99FLB080-1	99FLB080-1S
	1.00"	99FLB100-1	99FLB100-1S
	1.40"	99FLB140-1	99FLB140-1S
	1.70"	99FLB170-1	99FLB170-1S
	2.30"	99FLB230-1	99FLB230-1S
Fill Limit Vent Valve without GRV Communication	3.30"	99FLB330-1	99FLB330-1S
	1.40"	99FLA140-1	—
	1.70"	99FLA170-1	—
	2.30"	99FLA230-1	—
	3.30"	99FLA330-1	—



99FLB230

Grade Valve

- Essential component of VaporTec and SecureStop
- When used in conjunction with a fill limit vent valve, allows proper venting when the fuel tank is in unusual angles
- Prevents liquid fuel reaching the carbon canister and vent system during vessel operation, trailering and storage
- Integrated impact protection feature
- Compatible with Ethanol blended fuels
- Passes all USCG CFR 33 and ABYC H-24 fire test requirements

Description	OEM Part #	Part #
Grade Valve	99GVP000-1	—
Grade Valve Tank Gasket	99GVG000-1	—
Kit, 99GVP000-1 Grade Valve and Tank Gasket	99GVPKT-1	—
Internal Grade Valve	99GVN900-1	—



Testers

Description	OEM Part #
3 psi Assembly Tester for 99DFCC or 99DFPV Deckfills	99USCGTESTER
3 psi Assembly Tester for 99DFCC Deckfills	99USCGTESTERCC
3 psi Assembly Tester for CC and PRV Direct Fills	99USCGTESTERPRV

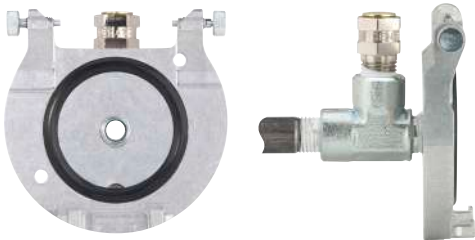

99USCGTESTER



99USCGTESTERPRV



99USCGTESTERCC

Accessories

For Portable and Integrated Fuel Systems



12822

Motor Well Boot

Motor well boot provides organized, covered pass-thru for control cables, wires, or fuel lines. Split side allows for installation without disconnecting controls. Includes tie for secure fit. Black rubber, UV-resistant construction with polypropylene attachment gasket ring.

Description	OEM Part #	Part #
For 4"-diameter opening	—	12820-5



11526

Fuel Tank Strap Sets

1"-wide white nylon web strap with zinc-plated carbon steel snap and quick-release buckle. Includes metal foot-man securing loops and screws.

Description	OEM Part #	Part #
48" long for 3-6 gallon tanks	—	11526-3
72" long for 12-gallon tanks	—	11512-3



14582

14580

Filter Funnels

Fine mesh screen filters out most foreign matter. Lightweight floating polyethylene plastic.

Description	OEM Part #	Part #
Short rigid, with handle	14582-1	—
Long flexible, with handle	14580-1	—



88TC06

Portable Fuel Tank Cap with Tether EPA Certified

High-flow valve exceeds OEM engine fuel flow requirements. Ratchets to ensure proper seal. For 0-350 HP engines. Compatible with 8803LP/8806LP/8812LP/8812LLP Series portable fuel tanks.

Description	OEM Part #	Part #
Standard 2-1/4" Neck	—	88TC06-7



11841

Fuel/Water Separator Assembly & Filter

With Double Seal. Universal 3/8" (.85cm) ports.

Universal Fuel/Water Separator (11840)

- 10 Micron Filter and bracket included.
- Replaces Mercury 35-60494A4. Includes 2 brass plugs.

Fuel/Water Separator (11841)

- 10 Micron Replacement for: Mercury 35-60494-1, Aqua Power 6031, GLM 24940, Sierra 18-78250, SMI 15494, Valmar 52113, Marpac 7-0872

Description	OEM Part #	Part #
Universal Fuel/Water Separator	—	11840-7
Fuel/Water Separator	—	11841-4

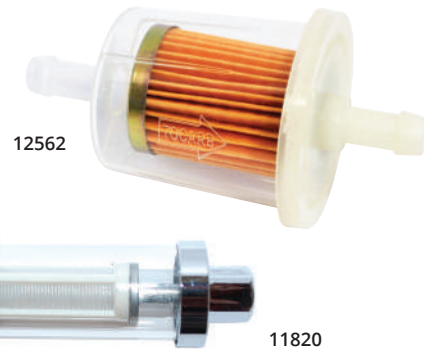

12562

11820

Outboard Fuel Filter

Disposable high-flow in-line fuel filters work with most outboard motors. Protects carbureted engines by trapping pollutants. Clear body allows visual inspection. High strength, impact resistant, and shatter resistant construction. Best to replace during winterize or spring start-up for optimum results.

Description	OEM Part #	Part #
Outboard Fuel Filter for 3/8" lines	—	12562-6
Universal In-Line Fuel Filter (1/4", 5/16", 3/8")	—	11820-7

Fuel/Oil Mixing Bottle

Allows the addition of the exact amount of oil required for a 2 cycle engine. Oil level marks are in gallons and litres. Determines ratios for 100:1, 50:1, 24:1 and 10:1 mixes. Wide mouth, quart size bottle.

Description	OEM Part #	Part #
Oil to Gas Mixing Container	—	11873-1



11873

Gear Lube Pump

For use with 32 oz. gear lube bottles. The pump fits any outboard or sterndrive to provide universal fit. Includes one Yamaha® adapter.

Description	OEM Part #	Part #
Gear Lube Pump	—	11891D7



11891

Universal Motor Flushers

Quickly flushes away salt, sand, silt, and alkali to prevent clogging and corrosion. The flusher attaches easily to an ordinary garden hose. Self-adjusting clamping yoke fits most domestic or imported I/O's and outboards. Molded cups deliver fresh water from a garden hose to flush the cooling system through side intakes on the lower unit. Note: Do not use full flow from hose.

Description	OEM Part #	Part #
Round with plastic body	—	9372-2
Round with metal body	—	16205-2
Rectangular motor flusher with metal body	—	16207-2
Universal dual water feed with metal body	—	16208-7



9372

16205

16207

16208

Portable Fuel Components—International (Not for use in the U.S.)

Fuel Line Kits

For use with portable fuel tanks and popular outboard engines. Made to the highest quality standards.



Engine & Tanks	End Fitting					Primer Bulb	Fuel Demand Valve	Part #
	Length	Dia	Tank Fitting	Fits Attwood Tank Fitting	Engine Fitting			
Universal	6'	3/8"	None	N/A	None	Standard	No	93806UI7
Mercury	6'	3/8"	8890LP6	8873-6	8894LP6	Standard	No	93806MI7
Johnson / Evinrude	6'	3/8"	8889LP6	8883-6	8889LP6	Standard	No	93806EI7
Yamaha	6'	3/8"	8896LP6	8897-6	8896LP6	Standard	No	93806YI7

Primer Bulbs

For easy replacement on any portable fuel line. Alcohol resistant, suitable for use with leaded and non-leaded fuels. Double check valve for quick priming and unrestricted flow. Non-corrosive, galvanized hose clamps. Strong and durable.



Description	OEM Part #	Part #
3/8" I.D Hose—International	—	9303817
5/16" I.D Hose—International	—	9351617



Integrated Fuel Components—International

(Gasoline Deck Fills Not for Use in the U.S.)

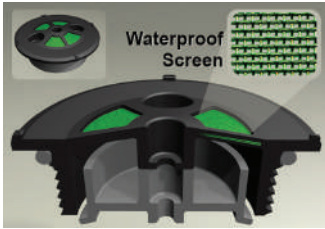

Vented Deck Fills

Attwood's vented deck fills incorporate an industry first patent-pending waterproof screen that eliminates the possibility of water entering a boat's fuel system, while also allowing your boat's engine to breathe freely. These deck fills exceed the ISO 10088 standard for minimum required venting area and meet all ABYC and US Coast Guard safety standards for marine fuel systems. Attwood's unique design includes an integral tank vent with flame arrestor and anti-surge technology. For CARB and EPA requirements (2012MY and newer), see 99DFCC and 99DFPV series gasoline deck fills (page 97).



Features:

- Integrated patent-pending waterproof screen eliminates the possibility of water entering your boat's fuel system
- Attwood's unique design includes an integral tank vent with flame arrestor and anti-surge technology, preventing fuel from escaping into the environment
- Engineered body designed for extreme strength
- Choose from oval or round, straight or angled configurations
- Round caps available in plastic, chrome or stainless steel to fit virtually any application and budget
- Stainless steel beaded chain to prevent loss of round Gasoline, Diesel and Water caps
- ISO symbols for Gasoline, Diesel, Water and Waste are located on top of the cap
- Deck plate key is included with gasoline fill
- Fits standard 1-1/2" fuel fill hose and 5/8" vent hose
- Requires (4) #8 screws

Description	Material	Location	Imprint	Cap Design	OEM Part #	Part #
Oval Vented Deck Fills						
Straight	Black Plastic	Not for US	Gasoline	Scalloped	99210GB1	—
Angled	Black Plastic	Not for US	Gasoline	Scalloped	99211GB1	—
Round Vented Deck Fills						
Straight	Black Plastic	Not for US	Gasoline	Scalloped	99200GB1	—
	Stainless Steel	Not for US	Gasoline	Scalloped	99200GS1	—
		Global	Diesel	Scalloped	99200DS1	—
		Global	Water	Scalloped	99200WS1	—
Angled	Chrome	Not for US	Gasoline	Scalloped	99200GZ1	—
	Stainless Steel	Global	Water	Scalloped	99200WZ1	—
Angled	Black Plastic	Not for US	Gasoline	Scalloped	99201GB1	—
	Stainless Steel	Not for US	Gasoline	Scalloped	99201GS1	—
		Global	Diesel	Scalloped	99201DS1	—
		Global	Water	Scalloped	99201WS1	—
	Chrome	Not for US	Gasoline	Scalloped	99201GZ1	—
		Global	Water	Scalloped	99201WZ1	—
Round Waste Deck Fills						
Straight	Stainless Steel	Global	Waste	Scalloped	99202WS1	—
	Chrome-plated Zinc	Global	Waste	Scalloped	99202WZ1	—
Angled	Stainless Steel	Global	Waste	Scalloped	99202AWS1	—
		Global	Waste	Y1	99202AWSY1-1	—



99210GB



99200GS



Y1 Flat cap



Scalloped cap

1-1/2" Deck Fills, Enhanced 316 Stainless Steel Alloy

For 1-1/2" I.D. hose. Deck fills available with imprint to specify GASOLINE, DIESEL, WATER, or WASTE. Highly-polished finish. Flush cap is slotted for separate key and features an O-ring that seals the cap watertight. Cap is attached by a stainless steel beaded chain. 3-1/4" long fill neck. Key sold separately. 66126 waste model has internal threads for pump-out nozzle. Use for vessels with built-in holding tanks. Note: Requires a bonding wire to prevent sparking when nozzle is inserted on gas and diesel models per USCG and ABYC H-24 requirements.



Specifications

Part #	Fill Neck Length	Installation Hole Size	Flange Size	Hose Size	Fastener Size
66406, 66407, 66408	3-1/4"	1-7/8"	3"	1-1/2" I.D.	#10
66126	3-1/4"	2-1/4"	3-1/2"	1-1/2" I.D.	#10

Description	OEM Part #	Part #
"Gasoline" imprint with Red Color Code (Not for use with EPA Certified systems)	66446C1	66406-5
"Water" imprint with Blue Color Code	66408C1	—
"Waste" imprint with Black Color Code	66126C1	—
Replacement key	66060-1	—
Replacement cap and chain†	—	66074-3
Replacement cap and chain only for 66126	—	66061-3



66446C



2" Deck Fills, Enhanced 316 Stainless Steel Alloy

For 2" I.D. hose. These deck fills are both imprinted and color-coded to specify either GASOLINE or DIESEL. Highly-polished finish. Flush cap is slotted for separate key and features an O-ring that seals the cap watertight. Cap is attached by a stainless steel, beaded chain. Long neck accommodates thick deck laminations. Key sold separately. Note: Requires a bonding wire to prevent sparking when nozzle is inserted on gasoline and diesel models per USCG and ABYC H-24 requirements.



Specifications

Fill Neck Length	Installation Hole Size	Flange Size	Hose Size	Fastener Size
3-1/4"	2-1/4"	3-1/2"	2" I.D.	#10

Description	OEM Part #	Part #
"Gasoline" imprint with Red Color Code (Not for use with EPA Certified systems)	66411C1	—
"Diesel" imprint with Green Color Code	66412C1	—
Replacement key	66060-1	—
Replacement cap and chain	—	66061-3



66411

† Replacement for 66406, 66407, 66408 and 66408C1 only

Fuel Vents

Enhanced 316 Stainless Steel Alloy Flush-Mount Fuel Vents

On the exterior, they have a smooth edge over the competition. Unlike some others, there is no protruding cap to cause damage — or be damaged by — hull bumps and scrapes. Cap unscrews with hex head wrench for easy cleaning of filter and pressure testing of entire fuel system. These vents now include two silicone gaskets.

Description	Hose Size	Maximum Hull Thickness	Installation Hole Size	OEM Part #	Part #
Straight Vent	5/8" I.D.	7/8"	1-3/8"	66031-1	66031-3
90° Vent	5/8" I.D.	7/8"	1-3/8"	66032-1	66032-3



66031



66032

Enhanced 316 Stainless Steel Alloy Fuel Vents

Stainless steel vents with spark-proof screen holes.

Description	Hose Size	Maximum Hull Thickness	Installation Hole Size	OEM Part #	Part #
Straight Vent	5/8" I.D.	1/2"	7/8"	66004-1	—
90° Vent	5/8" I.D.	1/2"	7/8"	66023-1	—



66004

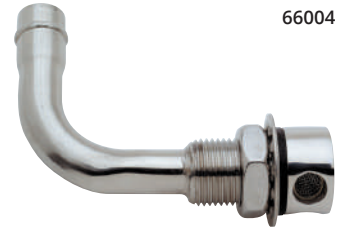

66023

Polypropylene Fuel Vents

Patented splash-resistant, corrosion-resistant polypropylene.

Description	Color	Hose Size	Maximum Hull Thickness	Installation Hole Size	OEM Part #	Part #
Straight Vent	Black	5/8" I.D.	7/8"	3/4"	1607-1	1607-3



1607

MARINE ACCESSORIES

Anchoring & Mooring Equipment



112

Attwood offers a wide selection of cast anchors, popular penetrating anchors, made in the U.S.A SoftSide fenders, and all the related accessories for a secure anchorage or mooring.

Marine Ropes & Cordage



118

Complete line of marine rope and cordage designed with the industries most recognized material and constructed for strength, flexibility, and durability.

Fishing Rod Holders & Accessories



125

Attwood's comprehensive selection has you covered for with all types of adjustable rod holders and interchangeable mounts.

Marine Maintenance Products



132

Ensure proper storage and cleaning of your vessel with Attwood maintenance products.

Interior & Boating Accessories



133

Attwood offers a variety of boating accessories to fit all your boating needs.



MARINE ACCESSORIES

Electrical Accessories



Attwood battery boxes are designed to better preserve your battery and protect those onboard. All battery boxes meet ABYC standard E-10 and U.S. Coast Guard specifications.

Paddlesports & Accessories



Designed with an optimum blend of quality construction and on-the-water performance, Attwood offers a wide selection of paddles, hardware, and storage accessories.

Trailing Parts & Accessories



Attwood offers a complete range of trailing equipment and accessories, for replacement and original equipment installation.

Horns



Complete line of industry leading marine horns to fit your desired frequency, size of your vessel, and style.

Wiper Motors, Arms & Blades



Attwood offers a wide variety of wiper systems specific to the marine industry designed for use in harsh environments.



Anchoring & Mooring Equipment

Mushroom Anchors

Mushroom anchors are an economical solution for light-weight boats. The wide-area mushroom cup provides sufficient holding power in mud and weed bottoms.

- Gray cast iron
- Large, steel eye
- Available coated with aluminum-painted finish or black PVC-coated finish

Description		OEM Part #	Part #
Aluminum - Painted	8 lbs.	9941-1	—
	10 lbs.	9942-1	—
	15 lbs.	9943-1	—
Black PVC-coated	8 lbs.	9941B1	—
	10 lbs.	9942B1	—
	15 lbs.	9943B1	—



Navy Anchors

Navy anchors combine weight with flukes to dig in and hold firmly in sand and mud. The reverse action of the shank allows quick retrieval of a fouled anchor. High-quality, gray iron casting available with aluminum-painted or black PVC-coated finish.

Description		OEM Part #	Part #
Aluminum - Painted	10 lbs.	9933-1	—
	15 lbs.	9934-1	—
	20 lbs.	9935-1	—
Black PVC-coated	10 lbs.	9933B1	—
	15 lbs.	9934B1	—
	20 lbs.	9935B1	—



River Anchors

River anchors catch and hold river bottoms where mud, rocks, stumps, and brush are present. Flukes act like a grappling hook to snag rocks or other objects. Gray, cast iron with a large, steel eye and black PVC-coated or aluminum-painted finish.

Description		OEM Part #	Part #
Aluminum - Painted	15 lbs.	9948-1	—
	18 lbs.	9946-1	—
Black PVC-coated	12 lbs.	9945B1	—
	15 lbs.	9948B1	—
	18 lbs.	9946B1	—



Note- All OEM Packed anchors include ID label with UPC number/bar code.

Penetrating Fluke Anchors

Penetrating fluke anchors dig into mud, sand, or gravel and stow flat. Pivoting flukes rotate downward into bottom. Excellent weight-to-holding power ratio compared to cast anchors. All Attwood penetrating anchors are manufactured of hot dip galvanized steel for corrosion resistance and strength. The assembly is arc-welded steel that maintains consistent fluke-to-shank angles, ensuring quick penetration and a firm hold.

Solid Shank Penetrating Anchors

Solid shank for durability and strength.

Specifications

Part No.	A	B	C	D
9955-1	22.25"	18.38"	12.20"	10.0"
9956-1	28.18"	21.0"	14.50"	11.0"
9957-1	32.0"	24.0"	16.50"	12.0"

Size	OEM Part #	Part #
#8	9955-1	—
#13	9956-1	—
#18	9957-1	—

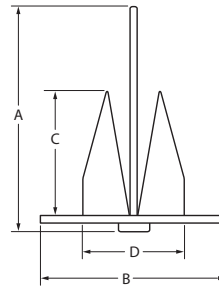

Slip-Ring Penetrating Anchors

Feature a slip-ring shank for easy retrieval of a snagged anchor.

Specifications

Part No.	A	B	C	D
9960-1	13.85"	11.50"	8.75"	8.0"
9961-1	16.35"	13.25"	8.88"	8.88"
9962-1	19.85"	14.25"	9.50"	10.0"
9963-1	21.85"	21.0"	12.0"	12.0"

Size	OEM Part #	Part #
#5	9960-1	—
#7	9961-1	—
#10	9962-1	—
#13	9963-1	—

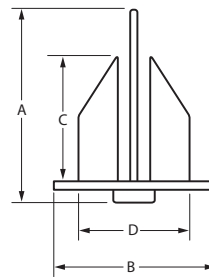

Grapnel Folding Anchors

Ideal four-fluke anchor for personal watercraft (PWC), small craft, and dinghies. Heavily galvanized, malleable iron. Folds up easily for storage. Lockable in opened or closed position.

Size	OEM Part #	Part #
3 lbs.	11964-1	—
5 lbs.	11966-1	—
7.5 lbs.	11968-1	—



Grapnel Anchor System

3.5 lb. anchor will hold your PWC, canoe, dinghy, kayak, or float tube in mud, sand, gravel, and rock. Includes 25 ft. of rope, marker buoy, giant snap hook, anchor, and durable, nylon storage case that protects your boat from scratches.

Description	OEM Part #	Part #
Grapnel Anchor System	—	11969-4



Note: All OEM Packed anchors include ID label with UPC number/bar code.

Anchor Chains and Shackle

For use on penetrating anchors. Anchor lead chain holds down anchor shanks, in order to keep anchor flat. Increases holding strength, especially in strong currents, high winds, and coastal waters. Protects line from chafing on sharp rocks. These anchor chains include a welded, oversized link on each end for easy installation and anchor attachment.



13753-7

Description	Dimensions	OEM Part #	Part #
Hot dip galvanized with 2 shackles	1/4" x 4'	—	13753-7

Lift 'n Lock Anchor Control

Easy-to-use anchor lift and pulley system supports anchors up to 20 pounds with 1/2 inch diameter line (sold separately).

Deluxe Anchor Control

- High-impact, reinforced nylon
- Stainless steel shafts
- Easy pull-up, lock, and release

Standard Anchor Control

- Economical zinc-plated, steel anchor lift
- Nylon pulley system
- Steel sheave controls anchor from any position

Description	OEM Part #	Part #
Deluxe—Anchor Lift 'n Lock	—	13702-4
Standard—Anchor Lift 'n Lock	—	13700-7



13702



13700

Anchor Buoy

One-piece, heavy-duty construction uses premium marine-grade vinyl for softness, pliability, and superior durability. Built-in UV inhibitors help maintain high-visibility, fluorescent orange color. MicroGuard® technology further protects from rotting, mold, and mildew.

Description	OEM Part #	Part #
Buoy, 9"	—	9350-4



9350

Anchor Ring & Rope

Assists in anchor retrieval. Designed to lift anchor systems up to 80 lbs. where 10 feet or more of anchor chain is used. Lifting capacity based on anchor buoy size. Buoy sold separately.

Description	OEM Part #	Part #
Anchor Ring with rope	—	9351-2



9351

Softside Fenders

Attwood SoftSide fenders come with a lifetime guarantee against chalking, splitting, marring, deflating, and crushing. All SoftSide fenders are made in the U.S.A. and resistant to UV and fading. Soft to the touch and easy on hulls, consumers trust the Attwood name in fenders.

SoftSide Oval Mooring Fenders

Molded from a lightweight polymeric material that is soft to the touch, and easy on hulls, and resistant to UV, chalking, splitting, and crushing. Double-molded eye ends for extra strength. Seamless one-piece construction. Oval shape and ribbed sides resist rolling against hull.

- Sold in a display carton for easy display
- Guaranteed for life against splitting or bursting

Description	Color	OEM Part #	Part #
4"-dia. x 16" L	White	—	9354D1
	Blue	—	9354BD1
5"-dia. x 22" L	White	—	9355D1
	Blue	—	9355BD1
6"-dia. x 24" L	White	—	9356D1
	Blue	—	9356BD1
8"-dia. x 28" L	White	—	9358-1
	Blue	—	9358B1



Pontoon Fender

Description	Dimensions	Mounting Pattern	OEM Part #	Part #
Pontoon Fender	8 1/2" x 16 1/2" x 10"	Strap	—	93536-1



Pontoon Fender
93536

SoftSide Dock Fenders

Molded from a lightweight polymeric material that is soft to the touch, easy on hulls, and resistant to UV, chalking, splitting, and crushing. Seamless one-piece construction.

- Sold in a PDQ display carton for easy retail display
- Guaranteed for life
- Made in the U.S.A.

Description	Dimensions		Mounting Pattern	OEM Part #	Part #
Corner Dock Fender	11-3/4" x 11-3/4" x 4-1/2"	Fits 90° angle	(4) 5/16" holes	—	93531-1
Straight-Edge Dock Fender	18" x 3-1/2" x 4-1/2"		(3) 5/16" holes	—	93532-1
Slide-On Post Dock Fender	7" diam. x 15" height	Fits up to 2-3/8" O.D. Post	(4) 5/16" holes	—	93533-1
Round Corner Dock Fender	7" diam. x 15" height	Fits 90° angle"	(6) 5/16" holes	—	93534-1
Long-Edge Dock Fender	45" x 8-1/2" x 6"		(4) 5/16" holes	—	93537-1

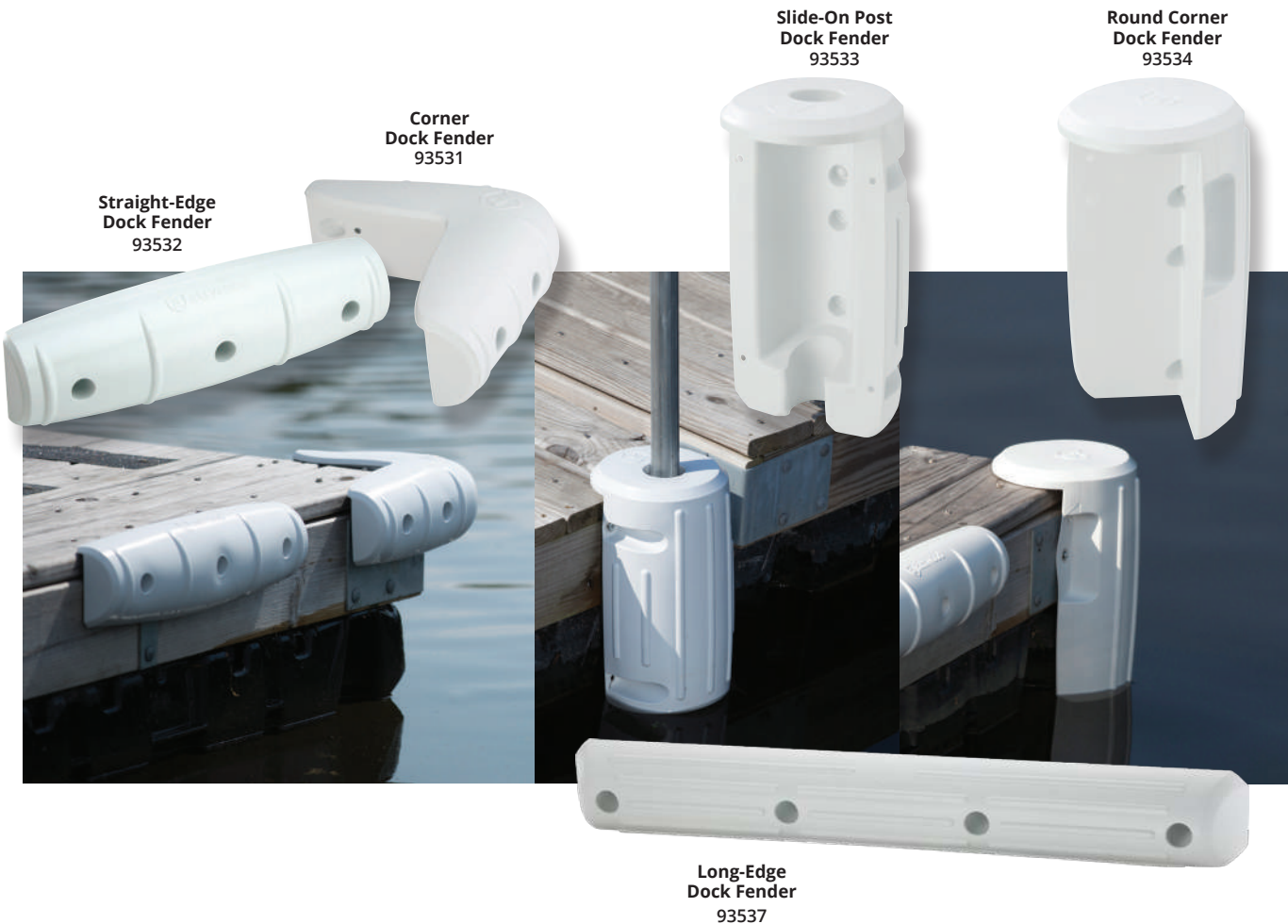

Note- All OEM Packed fenders include ID label with UPC number/bar code.

Fold-Down Dock Cleats

Ideal for small boats and watercraft. Cleats simply fold-down when not in use and flip back up when it comes time to tie off. Low-profile, fold-down design keeps cleat clear of dock traffic. Marine-grade aluminum protected with corrosion-resistant finish. Easy to install on all dock types with (2) standard 3/8 inch carriage bolts (not included).

Description	Color	OEM Part #	Part #
6" Fold-Down Cleat	White	—	12048-4
8" Fold-Down Cleat	White	—	12049-4



12048

Mooring Fender Lock Kit

Quickly and easily install or move fenders when mooring. Simply tie fender line onto key and insert key into lock. Includes (2) flush-mount stainless steel mounting plates and (2) stainless steel keys. Fasten with (2) #10 fasteners. Accepts up to 1/2 inch rope.

Description	OEM Part #	Part #
2" W x 1" H, Set	—	11575-3



11575

Boat Hook

Telescoping adjustment collar has molded ribbing – easy to grip and twist for length adjustment, even when wet. High-quality 6061-T6 aluminum tubing with marine finish and rubber vinyl grips. Hook includes non-marring polyethylene tips.

Description	OEM Part #	Part #
Extends 3-1/2' to 5-1/2'	—	11150-5
Extends 3-1/2' to 8'	—	11180-5



11180

Zig-Zag Fender Hanger

No need for knots in your fender lines. Keeps fenders in place with a simple system. Put line over rail and weave it through the zig-zag teeth.

Description	OEM Part #	Part #
Pair w/ 4' fender Lines	—	11952-7



11952

Marine Ropes & Cordage

Attwood offers a complete line of anchor and mooring products with the premium performance and quality that boaters have come to expect. Our rope products are packaged to look great, while meeting the sustainability and functional requirements demanded by our retail customers.

Rope Materials

Nylon

Nylon is recognized in the marine industry for its inherent strength, durability, and versatility. Its elasticity allows it to manage the sudden shock loads that would break ropes constructed from other materials, making it a leading choice for anchor and dock lines. Nylon is also abrasion resistant and will last much longer than natural fiber ropes.

Made from multifilament fibers that are light and heat stabilized, nylon rope is also resistant to rot, oils, gasoline, grease, marine growth, and most chemicals.

Benefits

- Strength
- Elasticity enables stretching and reduced breakage
- Resistant to UV light, rot, abrasion, mildew, oils, gasoline, and marine growth
- High wet strength

Polypropylene

Polypropylene offers high strength-to-weight performance and is available in many construction methods using monofilament fibers, which are smooth and velvety, and multifilament fibers. Both fiber types are UV stabilized to provide resistance against fading and degradation. Waterproof polypropylene ropes float and are also resistant to rot, oils, gasoline, and most chemicals.

Benefits

- Economical and versatile
- Resistant to UV light, rot, abrasion, mildew, oils, gasoline, and marine growth
- Floatable

Attwood Rope Construction Types



Twisted

- Splicable
- Economical construction
- The most common construction type for general purpose rope



Solid Braided

- Resists rotating underload
- Strong, soft, and light-weight construction
- Ideal for use in pulleys, guides, and blocks
- Resists unraveling when cut

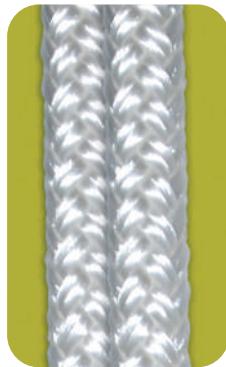

Double Braided

- Braid over braid construction (two ropes combined into one rope)
- Splicable
- Does not hockle, kink, or rotate underload
- Excellent shock absorption and elasticity



Diamond Braided

- High quality construction
- Tight interlacing of yarns
- Stiffer than solid braided rope



Hollow Braided

- Diamond braid construction with hollow center
- Easiest type construction to splice

Anchor Lines

Attwood offers anchor lines in different materials and construction types. Our twisted nylon construction is strong, hangs straight, and resists kinking. It can also be spliced, making it a favorite for the seasoned boater. Solid braided nylon lines are stable round cords that will not flatten out and will maintain a soft hand and flexibility throughout its life. We also offer a complete line of polypropylene anchor lines that are sure to meet the needs of any boater.

Premium Nylon Anchor Line

Available with Snap Hook or Thimble

Description	Thickness	Length	Color	OEM Part #	Part #
Twisted nylon line with hook	3/8"	50 ft.	White	—	11707-7
Twisted nylon line with thimble	3/8"	100 ft.	White	—	11734-1
		150 ft.	White	—	11708-1
		200 ft.	White	—	11716-1
	1/2"	100 ft.	White	—	11709-1



11707



11709

Solid Braided MFP Anchor Line

Available with Spring Hook or Thimble

Description	Thickness	Length	Color	OEM Part #	Part #
MFP line with spring hook	3/8"	50 ft.	White	—	11723-7
			Red	—	11736-7
			Blue	—	11741-7
			Black	—	11742-7
MFP line with thimble	3/8"	100 ft.	White	—	11724-1



11723



11724

Hollow Braided Polypropylene Anchor Line

Available with Snap Hook or Thimble

Description	Thickness	Length	Color	OEM Part #	Part #
Polypropylene with snap hook	1/4"	50 ft.	White	—	11714-2
Polypropylene with spring hook	3/8"	50 ft.	Blue/White	—	11725-2
			1/4"	100 ft.	Blue/White



11714



11725

Dock Lines

Attwood has a selection of dock lines to meet all boater needs for securing their boat to a dock or to other boats when rafting. Whether in nylon or polypropylene, we have dock lines in the most popular sizes and styles. Our nylon dock lines are the strongest and most durable lines available, plus they are resistant to the degradation effects of UV rays.

Our polypropylene dock lines are floatable. All Attwood dock lines are pre-spliced at one end.



3-Strand Twisted Nylon



Double Braided Nylon



Braided MFP



Hollow Braided Polypropylene



Premium 3-Strand Twisted Nylon Dock Line

Thickness	Length	Color	OEM Part #	Part #
3/8"	10 ft.	White	—	11711-7
	15 ft.	White	—	11705-7
1/2"	15 ft.	White	—	11706-7
	20 ft.	White	—	11733-7
	25 ft.	White	—	11715-7



11711

Premium Double Braided Nylon Dock Line

Thickness	Length	Color	OEM Part #	Part #
3/8"	15 ft.	Gold/White	—	11701-7
		White	—	117601-7
		Blue	—	117603-7
		Black	—	117604-7
20 ft.		Gold/White	—	117563-7
		White	—	117605-7
		Blue	—	117607-7
		Black	—	117608-7
25 ft.		Gold/White	—	117564-7
		White	—	117680-7
		Black	—	117681-7



11701

Premium Double Braided Nylon Dock Line

Thickness	Length	Color	OEM Part #	Part #
1/2"	15 ft.	Gold/White	—	117565-7
		White	—	117614-7
	20 ft.	Gold/White	—	117566-7
		Black	—	117617-7
	25 ft.	Gold/White	—	117567-7
		Black	—	117621-7
30 ft.	Gold/White	—	117684-7	
	35 ft.	Gold/White	—	117525-7



Braided MFP Dock Line

Description	Thickness	Length	Color	OEM Part #	Part #
Double Braided	3/8"	15 ft.	Blue	—	11702-7
			Black	—	11703-7
Solid Braided	3/8"	15 ft.	White	—	11737-7
			Red	—	11749-7
			Blue	—	11750-7
			Black	—	11752-7

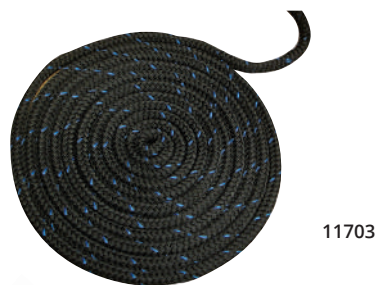

Mooring Snubber Kit

This flexible snubber stretches to absorb shock and protect boats, cleats, and lines from the strain of wind and water. The resilience of the snubber can be adjusted to conditions by increasing or decreasing the amount of line wrapped around it. Includes snubber and 20 ft. of solid braided multifilament polypropylene dock line.

Description	Thickness	Length	Color	OEM Part #	Part #
Mooring Snubber Kit	3/8"	20 ft.	Blue	—	11730-7



Hollow Braided Polypropylene Dock Line

- 15 ft. of hollow, braided polypropylene dock line
- All our polypropylene dock lines are floatable and pre-sliced at one end

Description	Thickness	Length	Color	OEM Part #	Part #
	3/8"	15 ft.	Blue/White	—	11728-2





11729

Expandable Dock Mooring Line

- Absorbs shock by stretching from 4 ft. to 5.5 ft.
- Convenient and easy to use -- eliminates excess lines
- Perfect for multiple boat tie ups
- Hollow-braid polyethylene line and shock cord construction

Length	Color	OEM Part #	Part #
4 ft.	Black	—	11729D5



11732

Launch Line

- Solid braid MFP line includes spring hook and handy foam grip
- Easy to handle floatable line that dries quickly
- UV Resistant
- Helps assist or steer your boat when launching or loading

Thickness	Length	Color	OEM Part #	Part #
5/16"	30 ft.	Blue	—	11732-7

Fender Lines

Attwood Fender Lines are constructed of double braided nylon for strength, flexibility, and durability. These premium lines feature a professionally spliced eye and are available in a range of diameters, lengths, and colors. Our Fender Lines will not be damaged by oil, grease, gasoline, mildew, or most chemicals.

Double Braided Fender Lines

Description	Thickness	Length	Color	OEM Part #	Part #
Double Braided Nylon, pair	1/4"	5 ft.	White	—	11843-7
		6 ft.	White	—	11971-7



11843

Utility Ropes

We have just the unique rope product and accessory that are always practical and valuable for the many uses around the boat, marina and home.



11704

Braided Polypropylene Utility Line

- Multi color offering
- 75 foot offering comes in PDQ retail display of four ropes
- 25 foot offering comes in PDQ retail display of three ropes

Thickness	Length	Color	OEM Part #	Part #
3/8"	25 ft.	Multi	—	11704-2



11710

11713

Hollow Braided Polypropylene Utility Line

Thickness	Length	Color	OEM Part #	Part #
5/16"	50 ft.	Blue	—	11713-2
1/4"	40 ft.	Yellow	—	11710-2
	50 ft.	Yellow	—	11720-2
	100 ft.	Blue	—	11721-2



11700

Diamond Braided Polypropylene Utility Line

- Great for miscellaneous uses around the boat, home, and marina
- Neon multi-color offering

Thickness	Length	Color	OEM Part #	Part #
1/8"	45 ft.	Neon Multi	—	11700-2



11717

Camouflage Cord Utility Line

- Diamond Braided MFP Camo Cord
- Great for hunting, fishing, boating, and camping
- 75 foot offering comes in PDQ retail display of four ropes

Thickness	Length	Color	OEM Part #	Part #
1/8"	50 ft.	Camo	—	11717-2
	100 ft.	Camo	—	11718-2
1/4"	50 ft.	Camo	—	11719-2



11726

Twisted Nylon Utility Line

Thickness	Length	Color	OEM Part #	Part #
1/4"	50 ft.	White	—	11726-2



117553

Solid Braided Nylon Rope

Thickness	Length	Color	OEM Part #	Part #
3/16"	100 ft.	White	—	117553-7



117561

Diamond Braided Nylon Rope

Thickness	Length	Color	OEM Part #	Part #
1/4"	50 ft.	White	—	117561-2



11739

Winch Ropes

Durable winch ropes available in braided nylon and twisted polypropylene. For winches rated up to 1,200 lbs.

Thickness	Length	Material	Color	OEM Part #	Part #
3/8"	20 ft.	Twisted Polypropylene	Black	—	11739-2



11712

Marine Bungee Cord Pack

Ideal for boat covers and general use.

- High tensile strength steel hooks with protective coating
- Contains: (8) 24" White, (6) 30" Blue, (2) 42" Yellow and (2) Adjustable Hooks for customizing length

Description	Length	Color	OEM Part #	Part #
18 Piece Assortment	Multi	Multi	—	11712-7



11753

Flat Bungee Set

5-piece set includes 12", 15", 25", 35" and 45" premium flat bungees with plastic encapsulated hooks. Individual colors.

Description	Length	Color	OEM Part #	Part #
5-Piece Assortment	Multi	Multi	—	11753-7

Marine Rope Accessories

Rope Wraps

Wrap around and hold your ropes, cords, hoses, and more.

Description	OEM Part #	Part #
Three (3) 1" x 12" straps, with sewn in hook-and-loop fasteners	—	11792-6



11792

Fishing Rod Holders & Accessories

Make Attwood your fishing source

Now, more than ever, Attwood is your best source for adjustable rod holders and interchangeable mounts. We think you'll agree — Attwood's comprehensive selection has you covered for all types of rod holders!



5010



5009

Pro Series Rod Holders

Designed for use with bait casting and spinning reels. Heavy-duty, deep-tooth gear lock securely holds rod holder in mounting base.

Mount	Color	OEM Part #	Part #
Combo	Black	—	5010-4

Heavy-Duty Adjustable Rod Holders

Designed for use with bait casting and spinning reels. Features an ergonomic design and easy-to-find rapid-release latch. The large, easy-grip lock-nut offers an easy 180° vertical adjustment range for a variety of rod tip height settings.

Mount	Color	OEM Part #	Part #
Combo	Black	—	5009-4
	White	—	5009W4
Flush	Black	—	5014-4



RH-4646

2-In-1 Non-Adjustable Rod Holders

Features fixed vertical angle to optimize rod positioning. Smaller size is perfect for medium and light action gear. Rod throat opening fits most standard and ultra-light rods up to 1-3/16 inches diameter. Locking ring fits spinning reel handle shanks up to 7/16 inch diameter. Available as a double-pack.

Mount	Color	Pk Qty	OEM Part #	Part #
Side	Black	2-pack	—	RH-4646

Note - 2-In-1 OEM Packed Rod Holders include ID label with UPC number/bar code

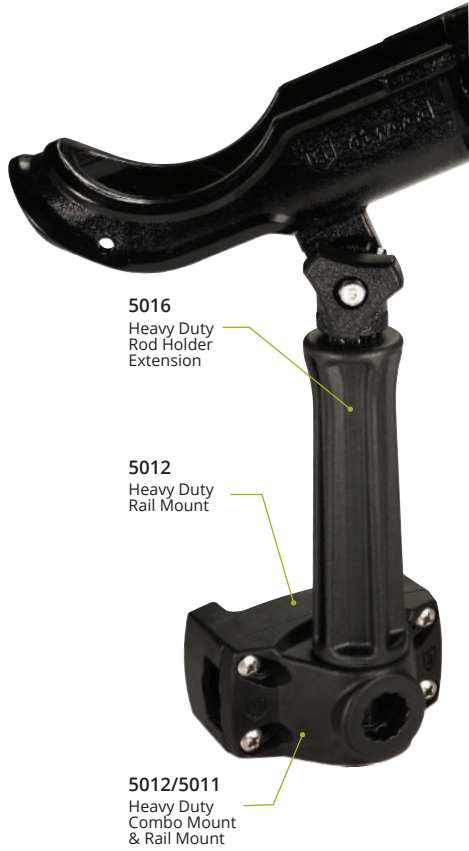

5016
Heavy Duty
Rod Holder
Extension

5012
Heavy Duty
Rail Mount

5012/5011
Heavy Duty
Combo Mount
& Rail Mount



Heavy-Duty Rod Holder Extensions

For use with all Attwood mounts including combo mount, Attwood standard side mounts, and other leading rod holder mounts. Complete with all necessary hardware to mount to round or square 7/8 inch to 1-1/4 inch diameter rail.

Description	Color	OEM Part #	Part #
Extension	Black	—	5016-3



Heavy-Duty Rail Mount

For use with the Heavy-Duty Combo Mount. Complete with all necessary hardware to mount to rails from 3/4 inch to 1-1/4 inch width.

Description	Color	OEM Part #	Part #
Rail Mount	Black	—	5012-7



Heavy-Duty Combo Mounts

The combo rod holder mount allows for mounting in multiple configurations. This new design offers an improved fit with positive lock for secure rod holder mounting. Can be mounted on side or top of gunwale. Compatible with all Attwood and other leading rod holder mounting patterns.

Description	Color	OEM Part #	Part #
Combo Mount	Black	—	5011-7



5022

Flush Mounts

Mounts flush to gunwale or deck. Easy-open cover conceals fasteners and elastomeric liner seals water out. When closed the low profile, smooth, contoured design avoids snagging lines.

Description	Color	OEM Part #	Part #
Flush Mount	Black	—	5022-7



5030-4

Heavy-Duty Clamp-On Rod Holder Mount

Heavy-duty adaptor clamp easily mounts rod holder to gunwale or transom. Ideal for aluminum fishing boats and pontoons. Works together with Attwood's Heavy-Duty Combo Mount and other Attwood fishing accessories. Mounting hardware included.

Description	OEM Part #	Part #
Gunwale/Transom Rod Holder Clamp	—	5030-4



5031

Clamp-On Rod Holder

Versatile Clamp-On Rod Holder features wide adjustability and a universal clamp design that allows easy mounting to gunwales, transoms, and rails. Constructed of powder coated steel for durability and long life.

Description	Color	OEM Part #	Part #
Clamp-On Rod Holder	Black	—	5031D1



9709

Mini Rigger Kit

A complete package to start downrigger fishing. Attwood's Mini Rigger Kit bring controlled-depth trolling capabilities to boats of all size. Kit includes Heavy-Duty Combo Mount for multiple mounting configurations, heavy-duty and easy to use professional line release, swivel head pulley to respond to line movements, 100 ft. of stainless steel line, 4 lb. cannonball weight, and an easy grip handle.

Description	OEM Part #	Part #
Mini Rigger with Harness	—	9709-7



11848

Lure Rack

The lure rack holds up to 25 lures, plus a fillet knife and pliers. Has slots for fillet knives.

Description	OEM Part #	Part #
Lure Rack	—	11848-4

Sure-Grip Steel Rod Holders & Mounting Bases

Attwood's line of Sure-Grip Steel Rod Holders are the perfect complement to our molded Pro-Series and Heavy-Duty Adjustable rod holders. They are designed for drift fishing, pan fishing, crappie, and more. Make Attwood your single source for all types of rod holders! The 3/8 inch diameter coated steel rod is tough, strong, and corrosion-resistant. UV-resistant plastic coating protects the rod butt and handle. Stainless steel exposed stem and wing nut offer years of corrosion-resistant use. Attwood Sure-Grip mounting bases fit a variety of mounting surfaces including rails. Constructed of extruded aluminum.

Sure-Grip Mounting Bases

Base	Fits	OEM Part #	Part #
Flush base, fits	2" flat surfaces	—	5071-3
Flat rail base, fits	square rail	—	5072-7
Clamp-on rail base, fits	round rail up to 7/8"-dia.	—	5074-3



5071

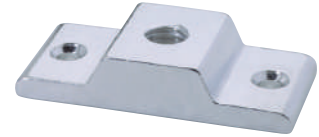

5072



5074

Sure-Grip Stainless Steel Rod Holders

Angle	Stem Length	Use for	Includes	OEM Part #	Part #
5° Angle	4" w/ Wing Nut	horizontal rod position	5071 mounting base	—	5060-3
5° Angle	8" w/ Wing Nut	horizontal rod position with added clearance	5071 mounting base	—	5061-3
25° Angle	4" w/ Wing Nut	drifting or trolling	5071 mounting base	—	5062-3
			pair of rod holders and 5071 mounting bases	—	—
45° Angle	4" w/ Wing Nut	trolling	5071 mounting base	—	5063-3



5060



5061



5062



5063

Stainless Steel Flush Mount Rod Holders

Attwood Stainless Steel Rod Holders answer the need for the finest in finish, function, and durability. The holders are available in 30°, 15°, and 0° configurations in standard 2 inch diameter. All Stainless Steel Rod Holders have these outstanding features, including optional custom-casting or electrolytic etching of your logo in the flange. Contact your Attwood representative for details.

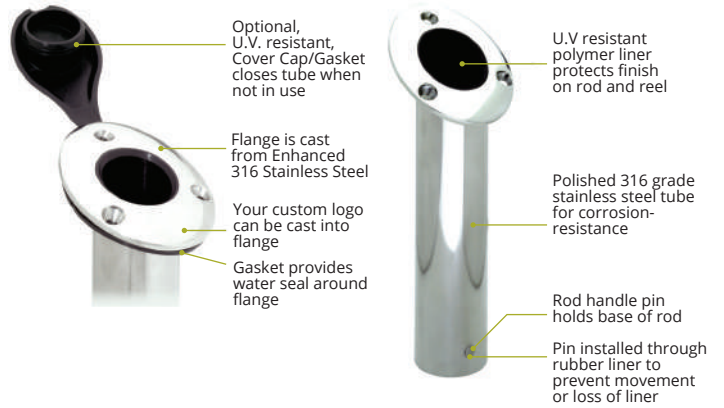

Closed End Rod Holders

• 2" Diameter x 9" Length

Description	Flange Shape	End Type	Gasket Color	OEM Part #	Part #
30°	Round	Closed	Black	66470-1	66470-7
0°	Round	Closed	Black	66471-1	—



Standard Series Rod Holders

• 2" Diameter x 7-1/2" Length

Description	Flange Shape	End Type	Gasket Color	OEM Part #	Part #
30°	Oval	Open	Black	66362-1	66362-7 ▽
			White	66362W1	66362W7 ▽
15°	Oval	Open	Black	66363-1	66363-7 ▽
			White	66363W1	66363W7 ▽
0°	Oval	Open	Black	66364-1	66364-7 ▽
			White	66364W1	66364W7 ▽

▽ Includes Cap Gasket

Standard Series Cap Gasket

Description	Flange Shape	End Type	Gasket Color	OEM Part #	Part #
30°	Oval	Open	Black	1478-1	—
15°	Oval	Open	Black	1477-1	—
0°	Oval	Open	Black	1476-1	—



Hybrid Rod Holder

10 inch long ABS plastic tube with stainless steel cap.

Description	OEM Part #	Part #
30° angle	6450-1	—
0° angle	6451-1	—



Plastic Rod Holders

Durable ABS plastic construction. No liner needed. Holder is angled at 30° for proper rod tip tension. Installation hole size: 2-1/2 inch diameter. Flange has three holes for 1/4 inch screws. Accommodates standard rod grip sizes under 1-1/2 inch diameter.

Description	Color	OEM Part #	Part #
Open	Black	—	12701-5
Open, 8 pc Display	White	—	12703D1
Closed end	Black	12704-1	—



Stainless Steel Clamp-On Rod Holder

304 stainless steel with black composite liner. Can be used on vertical or horizontal rails. Adjustable for rails 7/8 inch to 1 inch diameter. 9 inch length, 1-3/4 inch inside diameter tube.

OEM Part #	Part #
—	66970-7



Rod Storage

PVC Rod Holder Storage

Durable white PVC tube side mounts with molded out area to accommodate standard rod grip sizes up to 1-3/4 inches. 9 inches long.

OEM Part #	Part #
—	12708-2



Boat Deck Rod Holder Set

Mounts rod and reel combo to deck of the boat. Prevents rod and reel from bouncing out of boat while traveling. Holds up to five rods.

- Set includes: (1) 10 inch (25 cm) strap for the handle end of the rods, (1) 6 inch (15 cm) strap for the tips and stainless steel mounting hardware.

Description	OEM Part #	Part #
Deck Rod Holder Set	—	12760-7



Vertical Mount Rod Holder

- Mounts vertically in application to hold 5-6 rods horizontally
- Molded rubber inserts secure rod butt and tip
- Holds in a crisscross manner, allowing storage of more rods in a smaller space

Description	OEM Part #	Part #
Vertical Mount, Rod Holder Set	—	12761-7



Rod Storage Holder

Holds up to three fishing rods. Closed-cell foam insert protects rod. Mounts vertically or horizontally. 8-3/4 inches L x 2-1/2 inches W.

Description	OEM Part #	Part #
Black ABS frame, black foam	—	12750-6



Fishing Nets

Fold-N-Stow Fishing Nets

Fold down for convenient and compact storage or extend for added reach with Attwood's line of Fold-N-Stow Fishing Nets. A flip of the handle opens and locks the net into place. Easily pull back the trigger and the net collapses down into a stowable size. Constructed of durable, knot-free netting.

Size	Ideal for	Fully Extended	OEM Part #	Part #
Small	Trout Fishing	24" L x 12.5" W x 10" D	—	12772-2
Medium	Variety of Applications	47" L x 16" W x 16" D	—	12773-2
Large	Heavy Duty Applications	81" L x 27" W x 27" D	—	12774-2

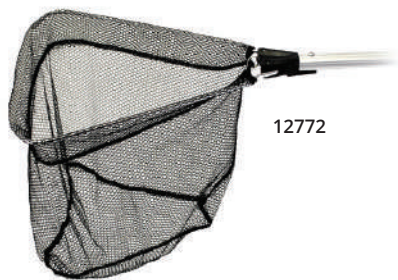

12772

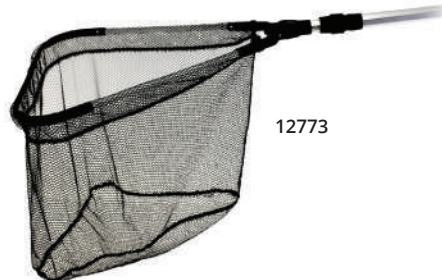

12773



12774

Marine Maintenance Products

Deluxe Deck Brush Kit

Kit includes:

- Soft brush with squeegee end for gentle, scratch-free cleaning
- Telescoping aluminum pole with flow-through design has water on/off switch and comfortable foam grips
- Nylon boat hook attachment



OEM Part #	Part #
—	11807-2



Spiral Watering Hose

- 3/4 inch end fittings
- Easy to store. No tangles, always kink-free.
- Weatherproof
- 3/8" I.D. x 25' Long

OEM Part #	Part #
—	11871-7



Prop Wrench Kit

- Offers multiple sockets to fit from 17/32 inch to 1-1/4 inch, allowing consumers to service multiple props.
- Built of durable composite.
- Wrench with up to 1-1/16 inch prop nuts

OEM Part #	Part #
—	11370-7

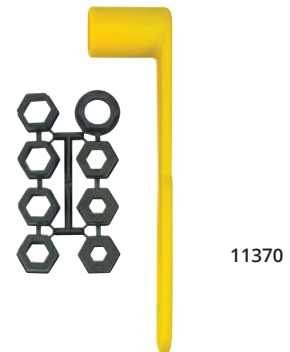

Interior & Boating Accessories

Soft Grip Steering Wheel

Ideal steering wheel for bass boats, sport boats, and runabouts. Patented design provides a comfortable, and firm grip. Contemporary styling with soft, black PVC outer rim and high-impact, one-piece plastic inner core. Resists UV rays to prevent fading. Soft Grip is non-magnetic so it will not interfere with compass readings. 3-3/8 inches deep dish. Fits all standard 3/4 inch tapered shafts and conforms to ABYC P-22 and ISO 8848.

- 8315 NMMA "As Approved": 090071; CE Certificate WATT004

Description	Center Cap	OEM Part #	Part #
13"-diameter rim	Black plastic	—	8315-4



8315
with cap

Tiller Line Clamp

Two screws lock plates together to hold tiller lines in place. Die-cast ZAMAK with chrome finish.

Description	OEM Part #	Part #
For 3/16" to 1/4" dia. line	—	8043-3



8043

Standard Glove Box

Plastic box and door are light-weight, yet sturdy. Door opens and closes easily on a stainless steel hinge pin and locks with a marine locking latch.

Door Dimensions	Inside Dimensions	Installation Hole Size
13-3/4" L x 5-1/2" H	11-3/4" L x 4" H x 6-5/8" D	12" L x 4-1/4" H

Description	OEM Part #	Part #
Black	2638-1	—



2638

Letter & Number Kit

- 3 inch, waterproof vinyl, pressure-sensitive labels
- Resists fuel, fading, and scratches
- Kit contains: Four of each letter and number, plus twelve dashes totaling 148 pieces
- Meets USCG guidelines

Description	OEM Part #	Part #
White, 148 pieces	—	14141-7
Black, 148 pieces	—	14142-7



14142

Rope Ladder

White, five-step boarding ladder. Sturdy 11-3/4 inch blow molded steps. Textured step surface for sure footing. Steps connected by a nylon rope with top loop that quickly secures to cleat or railing.

Description	OEM Part #	Part #
Rope Ladder	—	11865-4



11865

Hydro-Stabilizer

Gives outboards and sterndrives a performance boost, improving both stability and handling. The Hydro-Stabilizer out-performs ordinary flat hydrofoils by reducing drag when the hull goes on plane. Installs on a large variety of motor styles and sizes and includes stainless steel bolts and lock nuts. Wings constructed of black molded plastic. The Hydro-Stabilizer quickly puts the boat on plane and helps pull skiers out of the hole faster. Even at lower RPMs, it keeps the boat on plane. The wings provide a smoother, more stable ride and reduces prop cavitation in turns.

Description	OEM Part #	Part #
For outboards and stern drives 50 horsepower and above	—	9400-7
For outboards under 50 horsepower	—	9401-7

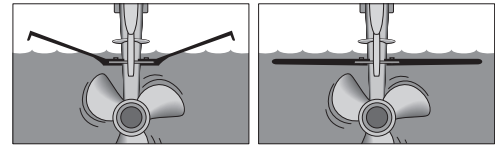

Hydro-Stabilizer

Ordinary Hydrofoil



9400



Safety Products



118091

Air Horn

Perfect for boating, sporting events, camping, and bicycles.

Description	OEM Part #	Part #
8 oz.	—	118092-7



11794

Portable Spot Light

Compact 5-watt LED spot light can be stored most anywhere on the boat. Light output is 400 fixture lumens with 50,000 hours of life. Tough thermoplastic construction in safety yellow/black. Includes a 12V "cigarette-style" adaptor plug with fuse.

Description	OEM Part #	Part #
Compact Spot Light w/10' power cord	—	11794-7



11830

Bailer Safety Kit

Kit Includes: waterproof emergency flashlight, bailer with easy-grip handle, 50 ft. marine rope with float, Pealess flat safety whistle with lanyard, and seamless "O" Ring.

Description	OEM Part #	Part #
5-Piece Kit	—	11830-2



11826-1

Telescoping Paddle

- Compact for easy storage
- Telescopes to 42" (1.06m) or 54" (1.37m)
- High impact plastic blade with corrosion-resistant aluminum pole

Description	OEM Part #	Part #
Paddle, telescoping - 3.5'	—	11828-1
Paddle, telescoping - 4.5'	—	11826-1



11889

Key Floats

Prevent loss of keys when dropped overboard. Three colors: orange, white and blue, with Attwood logo.

Description	OEM Part #	Part #
PDQ Carton, 24-Piece	—	11889D1



11875

Floating Key Buoy

- Water resistant
- Cover snaps tight for storage of small items
- Distinctive orange top for easy visibility

Description	OEM Part #	Part #
Floating Key Buoy	—	11875-7

Mirrors

Note: In some states and provinces, ski mirrors of a certain size/dimension, and/or an onboard observer may be required. Check local requirements.

Wide View Ski Mirror

For installation on windshields 1/2 inch to 1 inch thick (or thinner with customer's own spacer). Provides extra-wide mirror for safe visibility. Molded plastic frame, polished convex mirror, and adjustable base (up-and-down or side-to-side, then secures in desired location). Includes Allen wrench.

Description	OEM Part #	Part #
11-3/4" W x 4" H, Adjustable	—	13065-4



13065

Chrome Ski Mirror

Universal mount installs on dash or windshield. Shatterproof, 180° convex mirror eliminates blind spots. Mirror is compact and constructed of lightweight, chrome plated ZAMAK. Mirror adjusts to any position up-and-down or side-to-side, then secures in desired location.

Description	Dimensions	Max. Windshield Thickness	OEM Part #	Part #
Perma-Plate®, Adjustable	7-5/16" W x 2-1/2" H	3/4"	—	9083-7
Chrome-plated, Adjustable	7" W x 3-1/4" H	1"	—	13055-4



9083



13055

Clamp-On Ski Mirror

Universal mount fits up to 1/2 inch thick window frames and adjusts easily to meet most boat applications. Curved mirror provides a wide field of view. Soft touch mounting clamps protect windows and frames. Zinc plated hardware and powder coated shaft assembly.

Max. Windshield Thickness	OEM Part #	Part #
1/2"	—	13066-7



13066

Drink Holders



11786B



11786W

LED Stainless Steel Drink Holders

Convenient and stylish LED drink holder makes it easy to see in low-light conditions. The vibrant 35 Lumen interior light ring comes in blue and white to complement all boat interiors. 12 VDC.

Dimensions	LED Color	OEM Part #	Part #
3.2" D x 3.6"-dia.	Blue	11786B-1	11786B-7
3.2" D x 3.6"-dia.	White	11786W-1	11786W-7



11631

Molded Plastic Gimbaled Drink Holders

Self-leveling drink holders with slot for coffee cup handle. For boats, cars, and RVs. Molded plastic. Includes gimbaled surface-mounting bracket. Self-draining.

Description	Color	OEM Part #	Part #
4" H x 4-3/8" W	White	—	11631-4
	Black	—	11635-4



Recessed Drink Holders

Available in sizes for a variety of cans, bottles, and glasses. Each has holes for self-draining.

Size	Dimensions	Color	OEM Part #	Part #
Regular	1-7/8" D x 3"-dia.	Black	11787-1	—
Deep	2-7/8" D x 3"-dia.	Black	11788-1	—
Large	3-1/8" D x 3-3/4"-dia.	Black	11789-1	—
Large	3-1/8" D x 3-3/4"-dia.	White	—	11789WD1
Large	3-1/8" D x 3-3/4"-dia.	Stainless Steel	11845-1	—



Formed Wire Gimbaled Drink Holders

Formed, chrome-plated steel drink holders are ideal for boats, cars, and RVs. Includes a gimbaled surface-mounting bracket that keeps drinks level to prevent spills. Includes mounting screws.

Description	OEM Part #	Part #
Standard, ideal for 12-ounce cans	—	11670-4
Large, with slot for mug handle, includes cooler	—	11672-4

Fold-Up Drink Holders

Two easy-to-use, fold-up designs. Holds coffee mugs with a handle, 12-ounce cans, or drink insulators. Mount quickly and easily on boats or RVs. On dual-ring models, flip the small ring up to hold small drinks; for large drinks, flip the small ring down and use the large ring. When not in use, flip ring(s) down and close the cover for convenient storage. 7/8 inch closed depth. Four holes for #10 screws.

Description		Color	OEM Part #	Part #
Dual Ring	Polycarbonate construction 4-5/8" H x 4-9/16" W x 4-3/4" D	Black	—	2445-7
		White	2449-1	2449-7
Single Rigid Ring	Molded ABS plastic 3-7/8" H x 3-3/4" W	Black	—	11654-3

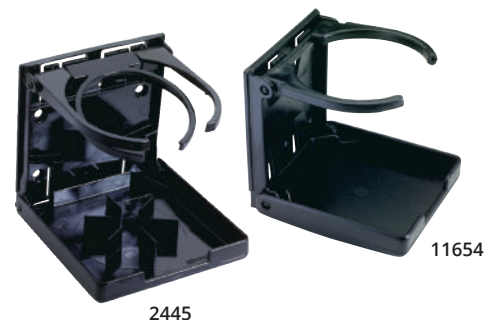

Storage Caddies

Storage caddies keep your boat organized. Easy-to-mount suction cups stay secure, even in rough conditions. Caddies can be mounted in back or on the bottom and can be permanently attached with screws. Non-corrosive white plastic.



Cockpit Caddy

Great organizer for fishing gear and personal items. Has slots for fillet knife, pliers, and over 22 lures.

OEM Part #	Part #
—	11849-2



Cruiser Caddy

Large storage space holds personal items and a beverage. Has slots for three lures and space for handled mug.

OEM Part #	Part #
—	11851-2



Safety Orange Boater's Box

Keep your maps, electronics, and other equipment safe while on the water.

- Perfect for use on the boat, at the dock, at home, or in the field
- The lift out tray is great for organizing small items and the flip-up lid provides easy access to your stored items
- Flip latch provides a secure method to keep your belongings safe

OEM Part #	Part #
—	11834-1



Cooler Mounting Kit

- Cooler corners stay put with straps to prevent injury or boat and cooler damage
- Quick disconnect strap design
- Corrosion resistant
- Fastens with #8 screws

Description	OEM Part #	Part #
Cooler Mounting Kit	—	14137-7



Dry Case Personal Storage

Heavy duty case protects personal gear and electronics. Waterproof up to 80 ft. Strong locking clasp and hinges. Includes carrying lanyard.

Size	Dimensions	OEM Part #	Part #
Large	7-1/4" x 4-3/4" x 1-5/8"	—	11896-1

Heavy-Duty Dry Bags

Heavy-duty, 500 denier PVC fabric construction in safety yellow with black accented components. Strong over-molded carry handle and lower draw straps for maximum compression.

Size	OEM Part #	Part #
40 Liter	—	11894-2
20 Liter	—	11897-2



11894

Electrical Accessories

PowerGuard PRO Battery Boxes **NEW**

Experience the difference of PowerGuard PRO Series Battery Protection

- Upward facing vents let gases out while reducing water in-take by 94% - vs. PowerGuard 27 Series.
- Polypropylene Composite material is impervious to acid leaks and other external factors.
- Engineered spill channels direct water away from the battery.

With PowerGuard PRO, your battery is always within reach

- Folding entry panels provide easy access to the battery terminals without the need to remove the mounting strap.
- Versatile bidirectional design allows contact from any angle.
- Ergonomic handles provide more comfort when transporting the battery.

PowerGuard PRO takes security seriously

- Reinforced mounting hardware ensures the battery and box stay anchored.
- Spacer blocks are removable to fit Group 24, 27, and 31 batteries.
- Snap locking lid gives confidence that the battery will remain secure.

POWER GUARD^{PRO}



Battery Box Description	Dimensions with Lid Installed		Color/Style	OEM Part #	Part #
	Internal Dimensions (L x W x H)	Outside Dimensions (L x W x H)			
PowerGuard PRO	13-1/8" x 7" x 11"	21" x 11-1/4" x 11-1/2"	Black, vented	9070-1	9070-7*
Accessories					
Mounting Hardware—Includes: PRO Mounting Strap, Reinforced Mounting Brackets, Stainless Steel Mounting Screws				9015-1	9015-3
Battery Spacers				9016-1	9016-3

* Retail pack comes with two battery spacers

** Max battery height without terminals is 9-5/16"

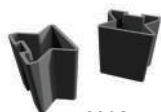

9016
Battery Spacers

- 1 Water-Resistant Ventilation:** Top facing ventilation minimizes water in-take through engineered spill channels, directing rain/splash away from batteries.
 - 2 Polypropylene Composite:** Polypropylene composite provides vital durability needed to support heavy lead battery cells, while resisting any run-off and UV discoloration.
 - 3 Folding Terminal Entry Panels:** Easily run terminal connected wires through folding terminal access panels, without the need to remove mounting strap.
 - 4 Snap-Lock Lid Design:** Locking lid provides peace of mind that lid will remain secure even under the most extreme of conditions.
 - 5 Free-Play Reduction Blocks:** Free-Play Reduction Blocks help ensure that 24 series battery cells are kept secure within the box, reducing damage to box and battery alike.
- **Reinforced Mounting Hardware:** Mounting hardware consists of reinforced mounting brackets and buckled strap to ensure box doesn't shift under heavy wave conditions.
 - **Bi-Directional Design:** Terminal Access Panels are positioned on either side of the box, allowing for maximum battery access.
 - **Ergonomically Designed Handles:** Ergonomic handles allow for easy transportation on and off vessels, trailers, and more.

PowerGuard Battery Boxes

Polypropylene construction for total acid resistance. Hold-down straps resist 350 lbs. of force, nearly four times the USCG requirement. Drop tested in temperatures ranging from -20°F to +120°F. Mounting hardware included.



9082

PowerGuard U1 Battery Box

For smaller batteries like Series 16 and those used in jet skis, power lawn, and garden equipment. Vented black battery box (5-7/8 inch maximum battery block height, 7-7/8 inch maximum battery height with terminals).



9065

PowerGuard 24 Battery Box

Vented and non-vented battery box for standard size, Series 24 batteries (8-3/16 inch maximum battery block height, 10-1/8 inch maximum battery height with terminals). Note: 9069 cover is non-vented and is not for marine use.

- Four cable openings, enlarged to .55 inch-diameter
- Larger handles with rolled edges
- Instructions molded inside cover



9084

PowerGuard 29/31 Battery Box

Vented black battery box for larger applications (7-15/16 inch maximum battery block height, 9-3/4 inch maximum battery height with terminals).



9067

PowerGuard 27 Battery Box

Vented black battery box for Series 27 batteries (8-1/2 inch maximum battery block height, 10-1/2 inch maximum battery height with terminals).

- Four cable openings, enlarged to .55 inch-diameter
- Larger handles with rolled edges
- Instructions molded inside cover



9076

Power Box, F27 Series

- LED battery level indicator with one-touch test button
- Heavy duty non-corrosive black plastic box
- Hold-down strap included
- 12V DC accessory adapter port with 10A fuse built-in
- External terminals

Battery Box Description	Battery Series	Dimensions with Lid Installed		Strap Length	Color/Style	OEM Part #
		Inside Dim. (L x W x H)	Outside Dim. (L x W x H)			
PowerGuard U1 Battery Box	U1	8-1/4" x 5-1/2" x 5-7/8" * 8-1/4" x 5-1/2" x 7-7/8" **	11" x 7-1/2" x 8-1/2"	40"	Black, vented	9082-1
PowerGuard 24 Battery Box	24/24M/24F	10-5/8" x 7" x 10-1/8"	14" x 9-5/8" x 10-5/8"	40"	Black, vented Black, non-vented	9065-1 9069-1
PowerGuard 27	27/27F/27M	13-1/16" x 6-15/16" x 10-1/2"	16-7/8" x 9-5/8" x 10-7/8"	40"	Black, vented	9067-1
PowerGuard 29/31 Battery Box	29/31	15-7/16" x 6-15/16" x 7-15/16" * 15-7/16" x 6-15/16" x 9-3/4" **	18-7/8" x 9-1/4" x 10-1/4"	38"	Black, vented	9084-1
Power Box	27F	—	—	44"	Black	9076-1

* Without terminals

** With terminals

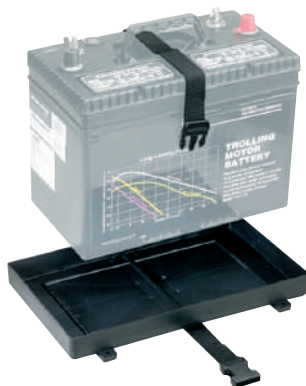

9092

Battery Tray with Straps

A simple-to-install battery holder that fits into limited spaces. For batteries up to 10-1/2 inches in height. Provide simple installation for changing or replacing batteries. The polypropylene hold-down strap has a positive locking, quick-disconnect buckle. Molded base mounts with four #10 panhead fasteners.

Battery Series	Inside Dimensions	OEM Part #	Part #
24/24M	7" L x 11" W	—	9092-5
27/27M	12-3/8" L x 7-1/8" W	—	9093-5
29/31	12-7/8" L x 7" W	9099-1	9099-5



9096

Heavy-Duty Battery Trays

Made of non-corrosive black plastic. Includes adjustable height crossbar and stainless steel retaining bolts. Meets ABYC Standard E-10 and U.S. Coast Guard requirements. Install with #10 fasteners.

Battery Series	Inside Dimensions	OEM Part #	Part #
24/24M	10-7/16" L x 6-7/8" W	9096-1	9096-5
27/27M	12" L x 6-7/8" W	9095-1	9095-5
29/31	13-1/16" L x 6-7/8" W	9094-1	9094-5



9097

Heavy-Duty Adjustable Battery Trays

Made of heavy-duty, non-corrosive, black plastic, this tray extends up to 9.5 inches, making it ideal for taller batteries. Includes adjustable-height crossbar and (2) retaining bolts. Contains no metal parts to corrode and no webbing straps to fade. Ergonomic nuts and bolts easily secure batteries. Meets ABYC Standard E-10 and USCG requirements.

- Rust-proof tray adjusts from 7-9.5 inches for taller batteries
- Made in the USA

Battery Series	Inside Dimensions	OEM Part #	Part #
24/24M/24F	10-5/8" x 6-3/4"	9097-1	9097-5
27/27M/27F	12-1/8" x 6-3/4"	9098-1	9098-5



9091

Low Profile Adjustable Battery Trays

Heavy-duty, non-corrosive black plastic. Includes adjustable-height crossbar and two retaining bolts. Meets ABYC Standard E-10 and U.S. Coast Guard requirements. Patented design. Install with #10 fasteners.

Battery Series	Inside Dimensions	OEM Part #	Part #
24/24M	10-5/8" x 7-1/4" x 8-1/2"	9090-1	9090-5
27/27M	12-5/8" x 7-1/4" x 8-1/2"	9091-1	9091-5

Battery Box Hold-Down Straps and Hardware

Straps are woven polypropylene with firm-grip buckles and are completely resistant to battery acid. Kit includes (4) #8, 3/4 inch screws and two footman clamps.

Description	Fits Battery Box(es)	OEM Part #	Part #
40" strap kit	9065, 9065A, 9067, 9082, 9069	9013-1	9013-3
40" strap only	9065, 9065A, 9067, 9082, 9069	9014-1	9014-3
54" strap kit	9084	—	9013A3
54" strap only	9084	9014A1	9014A3
Mounting hardware	—	9006-1	—



9013



11900

Battery Maintenance Charger

Fully-automatic on-board charger provides a 1.5 amp maintenance charge. Designed to maintain 12 volt batteries. Water-resistant with safety features, such as short circuit connection and reverse polarity protection. LED status indicators.

Specifications	OEM Part #	Part #
1.5A, 12V, 1 bank operation	—	11900-4



11901

Battery Charger

Dual rated 12V and 6V battery charger can be used for all of your marine, automotive, RV, and sport applications. The charger is compact and perfect for your bench, garage, or shop use. LED indicators let you know that your battery is fully charged. Overcharge, short circuit, and reverse polarity protection provide years of worry-free use.

Description	OEM Part #	Part #
12V/6V, 6A/2A Battery Charger	—	11901-4



14215

Polarized/Wing Nut Battery Terminals

Lead terminals with wing nuts and cadmium-plated bolts. Clamps are stamped with negative (-) or positive (+) sign.

Description	OEM Part #	Part #
Negative and positive, set	—	14215-6



14258

Battery Clips

Quick-connect battery clips for 12V electrical accessories. 10A rated, copper-plated construction with red and black handle grips. For use with wire up to 10-gauge.

Description	OEM Part #	Part #
Set	—	14258-6
Individual, Black	14258B1	—
Individual, Red	14258R1	—



14230

4-Way Battery Selector Switch

Single-pole, triple-throw switch permits four connection modes: battery one, battery two, two batteries in parallel, or both off. Rated for 300A continuous at 6V DC and 150A continuous at 12V DC. For 6V to 32V DC systems. Includes alternator field circuit disconnect to prevent surges. Selector has positive click positions. Bakelite housing with copper washers, brass terminals, and brass nuts. Install with #10 screws.

Description	OEM Part #	Part #
5-1/2" dia. x 2-3/4" deep	—	14230-3

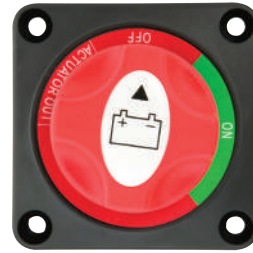

14233

Battery Switch

Compact and heavy-duty battery switch with removable control knob to deter theft. 12-50V DC / 200A continuous / 300A intermittent / on-off-separate.

For use with one battery.

- Ergonomic grips
- Removable walls for easy installation and access

Description	OEM Part #	Part #
12-50V DC, on/off	—	14233-7



14234

Dual Battery Selector Switch

Compact and heavy-duty battery switch with removable control knob to deter theft. 12V DC—Off/1/1+2/2 12V DC / 220A continuous / 400A 5 min intermittent / off. For use with up to two batteries.

- Ergonomic grips
- Removable walls for easy installation and access

Description	OEM Part #	Part #
12V DC, off/1/1+2/2	—	14234-7

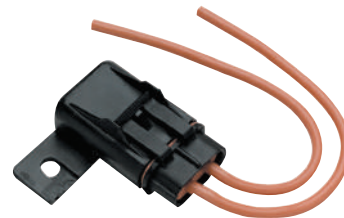

14348

ATO/ATC Fuse Holder

Watertight, extra heavy-duty, and weatherproof. For use with fuses up to 30A. 12-gauge wire leads for easy hook-ups. Fuse not included.

Description	Wire Size	OEM Part #	Part #
30A	12-gauge	—	14348-6

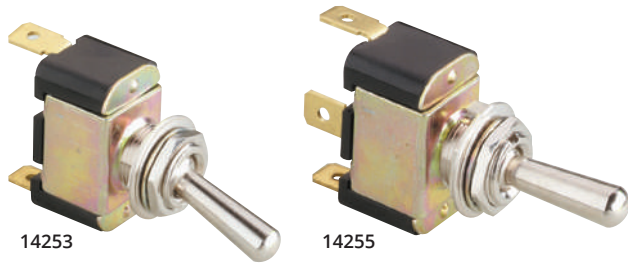

Toggle Switches

These metal toggle switches have 1/4 inch spade terminals. Rated for 10A, 12V DC only. Plastic body and housing with metal toggle and ring. Not external ignition protected.

On/Off Switches: Single-pole, single-throw contact. For lights, bilge pumps, or blowers.

On/Off/On Switches: For bilge pump, speed selector, or light that requires two power settings. Single-pole, double-throw contacts.

Installation Hole Size	Overall Dimensions	Depth Behind Panel	Max. Panel Thickness
3/8"-dia.	1-1/8" L x 5/8" W"	1-3/8"	1/4"

Description	OEM Part #	Part #
On/Off switch	—	14253-3
On/Off/On switch	—	14255-3



Boat Kill Switch Key Set

- Includes seven keys to fit Johnson, Evinrude, Mercury, Yamaha, Suzuki, Tohatsu and Honda kill switches
- Swivel snap hook prevents tangles
- Rust resistant stainless steel crimps
- Corrosion proof

Description	OEM Part #	Part #
Kill switch keys and lanyard	—	7591-6

Battery Adapter

Brass and plastic accessory plug for use directly with the battery. 150 watts. Comes with 3 ft. of wire, 12A, 12V.

Description	OEM Part #	Part #
Battery Adapter, 12 volt	—	11861-6

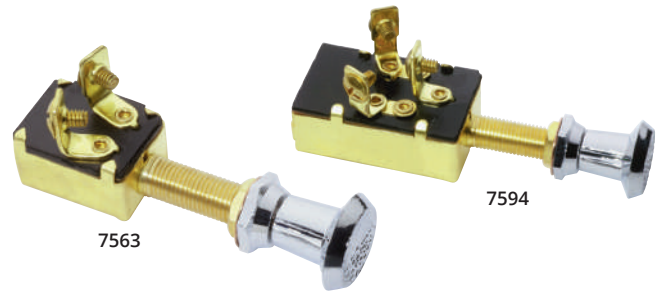

Push/Pull Switches

These switches have large easy-to-pull handles. They are commonly used for operating lights. 3/4 inch-diameter chrome-plated knob with brass case. Includes screw terminals for connection without a wire lug. For 12V DC only. Not external ignition protected.

Two-position Switch, Off/On: For operating one set of lights or another accessory.

Three-position Switch, Off/On/On: For operating running lights and anchor lights separately.

Installation Hole Size	Overall Dimensions	Depth Behind Panel	Max. Panel Thickness
3/8"-dia.	3-1/8" L x 1-1/4" W	1-1/2"	1"
3/8"-dia.	3-1/4" L x 1-1/2" W	2"	1"

Description	OEM Part #	Part #
Two-position	7563-1	7563-6
Three-position	7594-1	7594-3

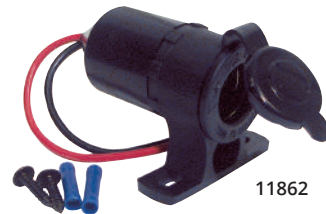

12V Marine Outlet

Marine quality 12V outlet is designed for replacing or adding outlets in your boat, RV or camper.

Description	OEM Part #	Part #
Surface Mount, 12V, Outlet	—	11862-6



14258

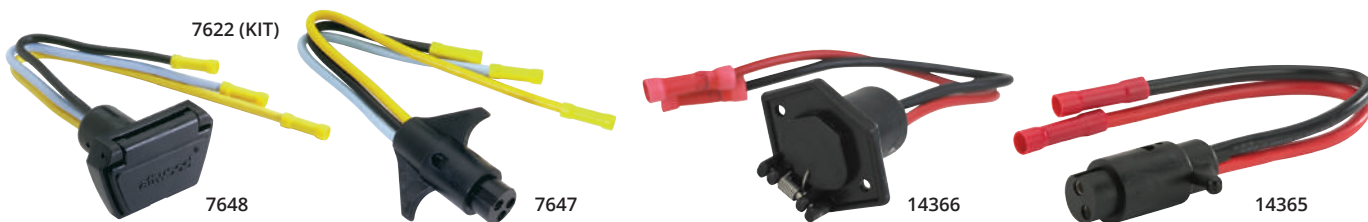

Heavy-Duty Trolling Motor Connectors

Use these connectors for quick, convenient connections between an electric trolling motor and a power source. 6 inch long wire harnesses with butt connectors.

Female Receptacle has weather cover and small face plate for flat surface mount. Two holes for #8 fasteners.

Male Plug has wing-tabs for easy installation and removal.

Plate Dimensions	Depth Behind Panel	Installation Hole Size
2-9/16" W x 1-3/4" H	2-1/4"	1-1/8"-dia.

Description	Wire Size	Volts	OEM Part #	Part #
Female receptacle, boat side	3-Wire 10-gauge	12/24V	—	7648-7
	2-Wire 8-gauge	12V	—	14366-6
Male plug, motor side	3-Wire 10-gauge	12/24V	—	7647-7
	2-Wire 8-gauge	12V	—	14365-6
Male/Female Kit	3-Wire 10-gauge	12/24V	—	7622-7



Medium-Duty Trolling Motor Connectors

Use these molded rubber connectors for quick easy connections between an electric trolling motor and the power source. 5 inch long harness with butt connectors. Receptacle (14350) includes weather cover and small face plate for flat surface mount. 10-gauge wire. For 12V DC only. Two holes for #8 fasteners.

Plate Dimensions	Depth Behind Panel	Installation Hole Size
2-1/2" W x 1-3/4" H	2-3/4"	1-1/8"-dia.

Description	Wire Size	OEM Part #	Part #
Female receptacle, boat side	10-gauge	—	14350-3
Male plug, motor side	10-gauge	—	14352-3

Trolling Motor Quick Connect

Safe and easy quick disconnect system. For use where a plug and socket cannot be used. Heavy-duty, 10-gauge connector, 22 inches long. Replaces battery clips.

Description	Wire Size	OEM Part #	Part #
2-Connector Kit	10-gauge	—	14367-6

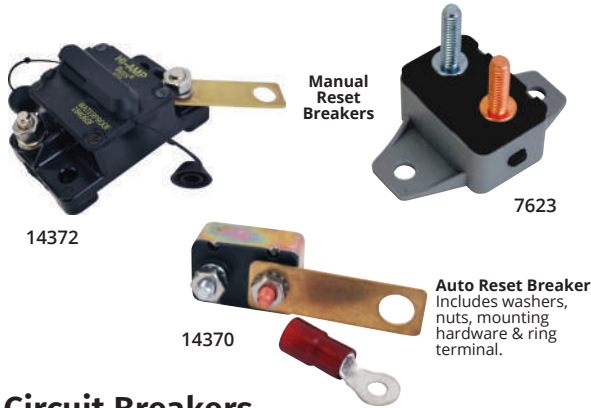

Manual Reset Breakers

Auto Reset Breaker
Includes washers, nuts, mounting hardware & ring terminal.



Circuit Breakers

A circuit breaker is an automatically operated electrical switch designed to protect an electrical circuit such as your trolling motor, or anything else electrical in your boat, from damage caused by overload or a short circuit.

Description	OEM Part #	Part #
60A Manual Reset with Ring Terminals	—	14372-7
50A Manual Reset	—	7623-7
Auto Reset with Ring Terminals	—	14371-6
40A Auto Reset with Ring Terminals	—	14370-6

Copper Wire

Stranded copper core is flexible for easy installation and allows the most current for quick starting. PVC insulation in the wire is resistant to cracking, abrasion, weather, oil, and acids.

Description	OEM Part #	Part #
8-ga. Red/Black, 20', set	—	14361-5



94110

Transducer Mounting Plate

- Mounts easily with only two screws
- Easy to adjust, add, or replace transducers.
- Marine-grade polymer plate will not warp, corrode, or be affected by UV rays.

Description	OEM Part #	Part #
Transducer mounting plate and hardware	—	94110-5



94100

Quick-Release Trolling Motor Mate Mounting Plate

For use with MinnKota® wireless trolling motors: AutoPilot, Grip Glide, Powerdrive, Terrova, RipTide ST and RipTide SP models

- Unique design eliminates tarp damage
- Easy on / easy off mounting - removes in seconds
- Exclusive locking feature
- Marine grade powder coat finish

Description	Part #	OEM Part #
Motor mate mounting plate and hardware	94100-4	—

Paddlesports & Accessories

Canoe Paddles

Aluminum Paddles

Heavy aluminum and rugged plastic construction. Ergonomic grip design. Poly-protective shaft grip.

Wooden Paddles

Economical and lightweight. Palm grip. Varnish finish.

Description	OEM Part #	Part #
Aluminum Paddles		
4 ft. Length	11764-1	—
4 ft. Length (Camouflage Green Blade)	11759-1	—
5 ft. Length	11765-1	—
Wooden Paddles		
2-1/2 ft. Length	11760-1	—
4 ft. Length	11761-1	—
5 ft. Length	11762-1	—



Stand-Up Paddle Board (SUP) Paddle

Paddle easily adjusts from 55 inches to 82 inches allowing families to share a SUP board. Constructed of heavy-gauge aluminum and engineered plastic components. Durable aluminum shaft with cupped 10° blade for increased efficiency and performance. Glass-filled ABS blade construction for long-term durability.

- Blade color – white
- Black, polypropylene grip
- Designed and engineered in the USA

Description	OEM Part #	Part #
SUP Paddle	—	11772-1

Kayak Paddles

Asymmetrical Paddles

Asymmetrical spoon blade paddles are designed to increase efficiency of stroke performance and reduce noise and blade flutter in the water. Made from heavy-duty aluminum and engineered plastic construction. Two-piece breakdown design with multiple angle positions that allow for customization for each paddler.

Description	OEM Part #	Part #
Asymmetrical Kayak Paddles		
7 ft. Length	11768-2	—
7-1/2 ft. Length	11766-1	—



Vibrant Asymmetrical Paddles

Unique blade shape increases stroke efficiency and minimizes flutter in the water. The combination of performance and vibrant colors create an expressive kayaking experience. Paddle angles can be adjusted when attached together for a more customized stroke based on skill level for both left and right-hand users.

- Graphics and vibrant color on each blade
- Tested for performance and durability
- Stay dry with pre-attached drip rings

Description	Color	OEM Part #	Part #
7 ft. Length	Orange-Red & White-Gray	—	11756-2
Adjustable, 7 ft.-7-1/2 ft.	Black	—	11758-2



11756



11758



11826-1

Telescoping Paddle

- Compact for easy storage
- Telescopes to 42" (1.06m) or 54" (1.37m)
- High impact plastic blade with corrosion-resistant aluminum pole

Description	OEM Part #	Part #
Telescoping - 3.5'	—	11828-1
Telescoping - 4.5'	—	11826-1



11780

Paddle Clips

Secures paddles for freeing up both hands or resting from paddling. Fits 1 inch diameter shafts.

Description	OEM Part #	Part #
1" diameter	—	11780-6

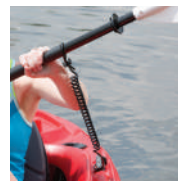

11909

Paddle Lanyards

Use the Standard Lanyard's sturdy clip or the Premium's velcro strap to secure your paddle and prevent dropping it overboard. Coiled bungee cord allows for advanced paddling with easy stowage.

Description	OEM Part #	Part #
Standard	—	11909-7



11944

Kayak Handle Replacement Set

Tough but comfortable, designed kayak carry handles for replacement on most kayak types and brands. The contoured grip makes carrying your kayak easier and more comfortable. Easy installation. Durable, black plastic and strong, braided rope.

Description	OEM Part #	Part #
Package of two	—	11944-7



9146

Oarlock Shanks

Made from heavy-gauge steel with a bright zinc finish. Adjustable and very easy to install; no holes to drill, clamp-on easily. One pair.

Description	OEM Part #	Part #
1/2" Shank, Pair	—	9146-6



9149

Oarlock Sockets

These heavy-duty sockets are made of heavy gauge steel designed to provide years of rugged use. The unique angle design allows for secure attachment to the boat that can outlast most original equipment sockets. One pair.

Description	OEM Part #	Part #
1/2" Socket, Pair	—	9149-6



11808

Rescue Line Throw Bag

50 ft. of 3/8 inch floating polypropylene line for water rescues. High visibility red bag with wide, yellow reflective strip for improved visibility in low light conditions.

Description	OEM Part #	Part #
50 ft.	—	11808-2



11595

11596

Hand-Operated Bilge Pumps

Safely remove unwanted water, and other liquids from kayaks and other small boats.

Description	OEM Part #	Part #
Kayak Hand Bilge Pump, 18"	—	11595-2
Hand Bilge Pump, 25", 32" Hose	—	11596-2



11776

Kayak Skirt

Keep water out of the kayak with this universal-fit spray skirt made with polyurethane-coated 210 Denier nylon. Dual-side adjustability and PVC-sealed seams. Mesh bag included.

- Universal (up to 40" long and 22" wide opening)

Description	OEM Part #	Part #
Kayak Skirt	—	11776-5



11775

Kayak Cockpit Cover

Universal-fit cover made with 210 Denier nylon. Has a 3/16 inch shock cord border and black, polypropylene clips.

- Universal (up to 40" long and 22" wide opening)

Description	OEM Part #	Part #
Kayak Cockpit Cover	—	11775-5



11778

Sit-On-Top Kayak Seat

Attwood's adjustable kayak seat provides a padded seat cushion and ample back support. Universal sizing for all sit-on-top kayaks. Four adjustable straps for a custom fit. Quick-drying, UV-resistant fabric with corrosion-resistant hardware. Durable nylon covering with additional storage bag on back of seat.

Description	OEM Part #	Part #
Foldable, clip-on kayak seat - Black	—	11778-2



12794

Deck Plates

Allow addition of storage options to your canoe, kayak, or small boat. Screw out design. High-impact ABS plastic is durable, rugged, and weather-resistant.

Description	Color	Fastener Quantity	OEM Part #	Part #
4"-dia.	White	#8 fasteners (6)	12790-1	12790-3
	Black	#8 fasteners (6)	12791-1	—
6"-dia.	White	#8 fasteners (6)	12792-1	—
8"-dia.	White	#8 fasteners (6)	12794-1	—

Paddlesports Hardware

Pad Eyes

All pad eyes are pre-drilled with two mounting holes.

- (2) #10 fasteners included

Description	A (Dia)	B (Long)	C	D	OEM Part #	Part #
Cast Stainless Steel	3/8"	1-7/8"	1-3/8"	1/2"	66105-1	—
Chromed bronze	5/16"	1-7/8"	1-3/8"	1/2"	12988-1	—



12988-1

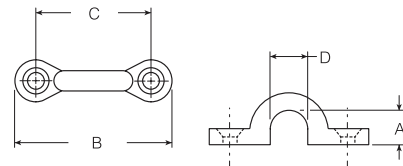

11783

Nylon Cleats

Ideal for tying off an anchor or for temporary docking. Includes (2) strong 4 inch lightweight cleats. Pre-drilled for #12 screws.

Description	OEM Part #	Part #
Nylon Cleats, set	—	11783-7



11950

11926

Zig-Zag Cleats

Makes a great primary cleat on kayaks, canoes, fishing boats and pontoons. Also good as a utility cleat on docks, piers, trailers, and more. 4 inch model handles rope up to 1/2 inch diameter. 3 inch and 3-1/2 inch models handle rope up to 3/8 inch diameter. One pair.

Description	OEM Part #	Part #
Zinc Plated, Pair	3"	11950-6
	4"	11951-6
Black Nylon, Pair	3-1/2"	11926-7

Paddlesports Transportation & Storage



Canoe Car-Top Carrier Kit

Simple, convenient kits for carrying canoes and small boats on car roof. Includes four supporting foam blocks that snap on boat's gunwale and help prevent scratches on car top. Two straps with adjusting buckles and clips. Includes 20 ft. of polypropylene rope and S-hooks to secure bow and stern to bumpers. Straps are sturdy poly web with vinyl-coated clips.

Description	OEM Part #	Part #
Car-Top Universal Canoe Carrier Kit	—	11437-7



Kayak Car-Top Carrier Kit

Simple, convenient kits for carrying kayaks on car roof. Includes two supporting foam blocks to support kayak and help prevent scratches on car top. Two straps with adjusting buckles and clips. Straps are sturdy poly web with vinyl-coated clips.

Description	OEM Part #	Part #
Car-Top Kayak Carrier Kit	—	11438-7

Kayak Roof Rack – J Style

Easy to install kayak carrier mounts securely and safely to most standard and aftermarket roof rack cross bars. J-style design allows for easy loading and unloading of kayaks. Durable powder-coated steel construction holds up to 120 lbs. Foam rubber protection pads and detailed instructions included.

Description	OEM Part #	Part #
Kayak Roof Rack Carrier Kit	—	11441-4



11930

Kayak/Canoe Cart

Haul your kayak easier than ever with Attwood's new Kayak/Canoe Cart, now with premium wheels! Enhanced large diameter wheels cannot deflate, simplifying transport over uneven terrain. Cart easily disassembles to fit into most kayak hitches. Holds up to 100 lb. loads.

Description	OEM Part #	Part #
Kayak & Canoe Cart	—	11930-4



11953

Kayak Hoist System

Complete hoist system for kayaks, canoes, bikes, ladders, and more. Hooks and locking mechanisms safely hold up to 120 lbs. Easy lifting pulley system and 2 inch wide webbing hang straps. Includes all mounting hardware.

Description	OEM Part #	Part #
Kayak Hoist System	—	11953-4

Trailer Parts & Accessories



14060

Submersible Trailer Light Kit

Complete kit includes a pair of 8-function stop/tail/turn lights, wiring harness, and license plate bracket. Applicable to trailers under 80 inches wide. Ideal for utility, snowmobile, camping, motorcycle, and boat trailers. Design conforms to applicable US FMVSS and Canadian CMVSS safety standards.

Description	OEM Part #	Part #
Submersible Kit	—	14060-7



14063

Low-Profile Submersible Trailer Light Kit

Low profile for trailers over 80 inches wide. The complete kit includes (2) multi-function lamps, wiring harness, license plate bracket, and mounting hardware. Ideal replacement lights for most boat trailers. Conforms to applicable U.S. FMVSS and Canadian CMVSS safety standards.

Description	OEM Part #	Part #
Low-Profile Submersible Trailer Light Kit	—	14063-7

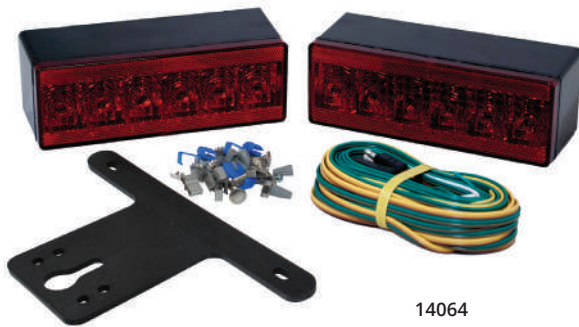

14064

LED Low-Profile Trailer Light Kit

Complete kit includes (2) multi-functional (stop/tail/turn) submersible low-profile LED trailer lights, license plate bracket, wiring harness, and installation hardware. Ideal replacement or upgrade for most trailers. Conforms to applicable U.S. FMVSS and Canadian CFMVSS standards.

Description	OEM Part #	Part #
Low-profile LED Light Kit	—	14064-7



14065

Submersible LED Trailer Light Kit

Complete kit includes (2) multi-functional (stop/tail/turn) submersible LED trailer lights, license plate bracket, wiring harness, and installation hardware. For use with trailers under 80 inches wide. Conforms to applicable U.S. FMVSS and Canadian CFMVSS standards.

Description	OEM Part #	Part #
Submersible LED Light Kit	—	14065-7



14066

Trailer Guide Lights

Trailer guide lights aid in backing and maneuvering trailers at boat ramps and in tight areas. Waterproof, bright red, LED lights make it easy to identify trailer angle and position, even in low light conditions. Mount to trailer frame or guidepost with corrosion-resistant aluminum and steel mounting. Mounting hardware not included.

Description	OEM Part #	Part #
Trailer Guide Light Assembly 27" L x 1/4" dia.	—	14066-7

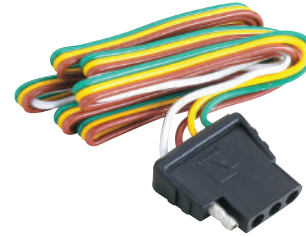

14017

Trailer Wiring Harness/Connectors

The most popular 4-way flat wiring harness kit for vehicles and trailers. Copper-stranded, color-coded wire and plastic molded terminals with four-prong trailer plug or vehicle socket. Both ends have 18 inch plug wire and 48 inch socket wire.

Description	OEM Part #	Part #
18" plug and 48" socket	—	7663-5



7621

Complete Trailer Wiring Kit

Kit Includes: (1) Receptacle and harness, 4 ft. (1.2 m), (1) plug and harness, 25 ft. (7.6 m), (4) blue quick connectors and (8) trailer wire attachment clips.

Description	OEM Part #	Part #
Complete Wiring Kit	—	7621-7



14133

Trailer Light Circuit Testers

The light indicators on this inline circuit tester show which circuit (tail lights, ground, left-or-right signal) is having problems.

Description	OEM Part #	Part #
Circuit Tester, Inline	—	14133-6

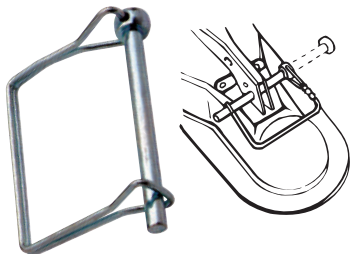

11029

Coupler Locking Pin

Quick connect and disconnect, to keep coupler from accidentally disengaging. Fits 2 inch and 3 inch couplers. Pin fits through coupler release handle to provide security and safety.

Description	OEM Part #	Part #
Solid zinc-plated steel, 2-1/4" W x 1-5/8" L	—	11029-6



12044

Coupler Security Lock

For maintenance-free trailer security. While this lock is in place, coupler cannot be used. Solid brass with rust-proof stainless steel shackle pin. Includes two keys.

Description	Shank Length	Dia	OEM Part #	Part #
Coupler Security Lock	5/8"	1/4"	—	12044-6



11011

Trailer Safety Chain with Spring Clips

Connects the trailer tongue to the trailer hitch on the towing vehicle for security and safety. Meets SAE specifications. Welded, solid steel with bright zinc-plated finish and hooks at both ends. Two chains required per trailer.

Description	Specifications	OEM Part #	Part #
Class II	51" L x 1/4" dia.	—	11011-7



11127

11126

Fold-Up Trailer Jacks

Fits 3 inch x 5 inch tongue. Swings up and out of the way. Corrosion-resistant, zinc-plated steel tubing. Swing-up jack has a convenient sidewind handle and a tough 6 inch diameter polypropylene wheel.

Description	Travel Lift	Lift	OEM Part #	Part #
1000 lbs. capacity, single wheel	10"	24"	—	11127-4
1500 lbs. capacity, dual wheel	12"	26"	—	11126-4



11130

Trailer Tongue Lift Handle

Convenient handle for maneuvering trailer tongue. Mounts easily to most trailer couplers.

Description	OEM Part #	Part #
Lift Handle	—	11130-7



6260

Non-Skid Pads

Precision 6 inch x 12 inch die-cut pads are simple to install on trailers, boats, and docking for additional safety. Rugged anti-slip surface is 100-grade coarse grit. A proven adhesive ensures long-lasting performance.

Description	OEM Part #	Part #
Non-Skid Pads, pair	—	6260-4



11401

Pontoon Storage Blocks

Great for fall and winter pontoon storage. Stable design keeps pontoon hull dry and off the ground. High-density, engineered composite protects pontoon surface. Conveniently stack together when not in use. Each block holds up to 4,000 lbs. capacity. Lightweight and easy to use. Will not absorb moisture.

Description	OEM Part #	Part #
Pontoon Storage Blocks Set of 4	—	11401-4

Trailer Winches

Many Factors Affect The Capacity Of A Winch In Pulling A Boat. As A Rule Of Thumb, Winches May Be Used To Trailer Boats Up To Two Times The Winch Capacity. For Example, A 1200-Lb. Capacity Winch May Be Used To Load Boats Up To 2,400-Lbs.

Caution: Attwood Winches Are Not Intended For Use As Hoists; For Lifting, Supporting, Or Transporting People; Nor For Lifting Loads Over People.



Dual Drive Winch—2,000 pound

Dual drive enhances the pulling capacity by distributing the load equally to two sets of gears. Eliminates frame torque. 2,000-lb. load capacity with 4.1:1 gear ratio. Three-position pawl provides forward, neutral, and reverse operations. Black EDC finish. Molded, textured roller grip. Includes 2 in x 20 ft. nylon web strap with zinc-plated snap hook.

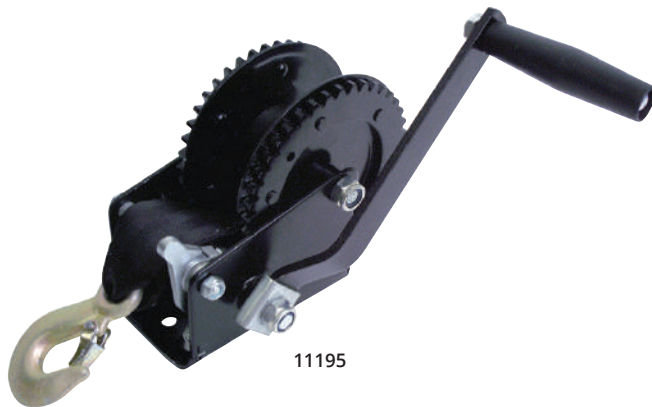

11195

Single Drive Winch—1,200 pound

Solid gear construction with precise gear tooth engagement. 1,200-lb. load capacity with 4.1:1 gear ratio. Three position pawl provides forward, neutral, and reverse operations. Black EDC finish. Molded, textured roller grip. Includes 20 ft. nylon web strap with zinc-plated snap hook.

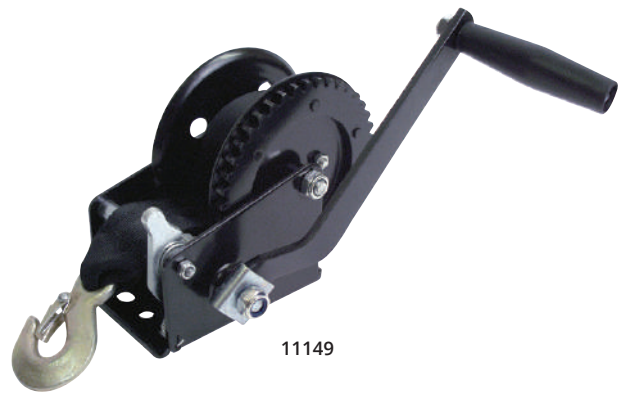

11149

Description	Type	Gear Ratio	OEM Part #	Part #
2000 lb. with 2" W x 20' L nylon strap	Dual	4.1:1	—	11195-4
1200 lb. with 2" W x 20' L nylon strap	Single	4.1:1	—	11149-4



Trailer Winch Straps

Winch straps, cables, and ropes are available to fit most winches, loads, and applications. A complete selection of winch products to meet every customer need and a variety of price points.

Selecting a winch strap, rope, or cable: NMMA, SAE, and BIA Standards require the minimum breaking strength of winch cable, rope, strap, and hook be at least 1.5 times the rated straightline pull of the winch. For example, if a winch rope has a breaking strength of 1,500 lbs., it can only be used on winches rated up to 1,000 lbs. All Attwood winch cables, ropes, and straps are rated for the winch on which they can be installed. Winch ropes, strap, and cable should have a minimum of four (4) complete wraps around the winch drum in the most extended position for launching or retrieving the boat.

You can depend on Attwood winch straps. They're easy to install and prevent tangling on winch drum. Built to be strong and durable. UV-resistant webbing with a special, heavy-duty, forged steel, snap hook. The extra-long throat is designed for easier attachment to bow eyes on boats. Two strap-end styles are available for easy, secure attachment to the winch drum. Rated for winches up to 2,000 lbs.

Webbing: Polyester webbing is one of the finest web strap materials available. Polyester does not stretch and offers excellent resistance to ultraviolet degradation from sunlight.

Strap-End Styles: Two styles available (1) Cut-End, and (2) Sewn-Loop End.

Hook: Heavy-duty, forged, zinc-plated steel snap hook. Spring-loaded closure for secure attachment. Extra-long throat for easy attachment.



11147-7

Description	Length	OEM Part #	Part #
Sewn-loop end	20 ft.	—	11147-7



11739

Poly Winch Ropes

Twisted polypropylene 3/8 inch diameter winch rope is economical, versatile, and easily spliced. Resistant to rot and mildew and is UV stabilized. For winches rated up to 1,200 lbs., not intended for other uses

Description	Color	OEM Part #	Part #
3/8" x 20' Long	Black	—	11739-2

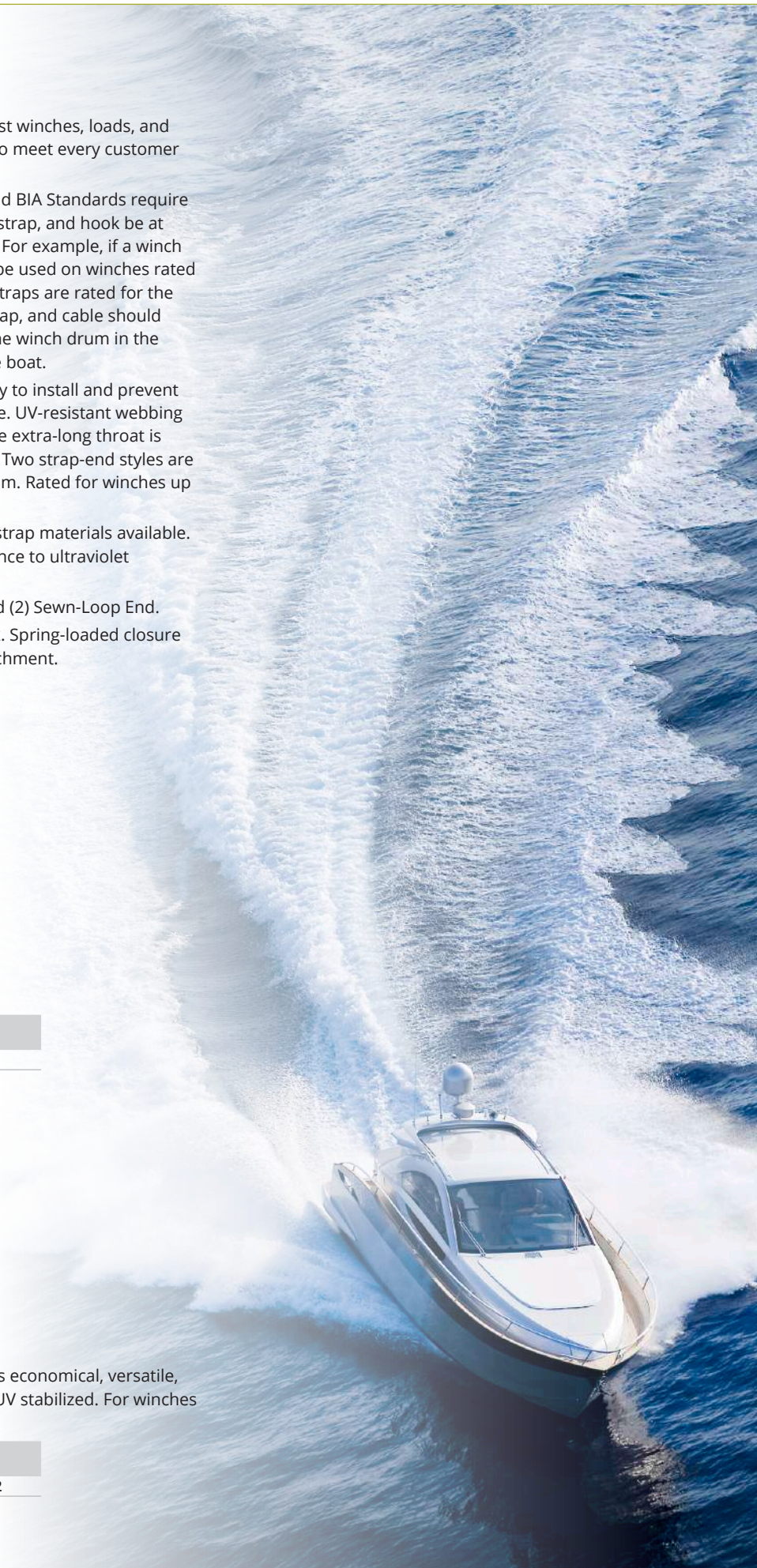

Bow Stops & Rollers

Road-ready bow stops, rollers, and roller brackets provide protective support for your boat's hull while it's on the trailer, and allow easier launching, centering, and retrieval of the boat. This assortment includes rollers, bow stops, and steel roller brackets. Rollers and bow stops are available in polymer or rubber.

Rubber Rollers	Polymer Rollers
Non-marring prime rubber compound	Will not mark or discolor your boat
Economically priced	Resist cuts and abrasions
Original equipment replacements for most trailers	Have superior durability to outlast ordinary rollers



Bow Rollers, Polymer

Non-marring, resilient bow protection. Smooth finish helps boat roll easily into place. Impervious to sunlight, chemicals, and fuels.

Description	Dimensions	Hole I.D.	OEM Part #	Part #
Bow Roller	3" O.D. x 3" L	1/2"	11881-1	—
Bow Roller	4" O.D. x 4" L	1/2"	11880-1	—
Bow Roller w/ Bells	3-1/2" O.D. x 4" L	1/2"	11857-1	—



Spool/Keel Rollers, Polymer

Smooth, non-marring, resilient protection. Impervious to sunlight, chemicals & fuels. Fits 1/2 inch diameter shafts.

Dimensions	Outside Diameter	OEM Part #	Part #
Spool/Keel Roller	4"	11315-1	—
	5"	11317-1	—
Keel Roller	8"	11319-1	—



Bow Stops, Rubber

Molded rubber stops. Each is pre-drilled with 3/8 inch or 1/2 inch diameter hole.

Dimensions	Hole I.D.	OEM Part #	Part #
2" x 2"	3/8"	11200-1	—
3" x 3"	1/2"	11201-1	—
4" x 4"	1/2"	11202-1	—



Bow Rollers, Rubber

Durable protective molded rubber bow rollers.

Description	Outside Diameter	Shaft Diameter	OEM Part #	Part #
3" length	3"	1/2"	11205-1	—
4" length	3-1/2"	1/2"	11209-1	—



Spool/Keel Rollers, Light-Duty Rubber

Durable and protective. Molded rubber with nylon inserts. 3 inch outside diameter.

Dimensions	Shaft Diameter	OEM Part #	Part #
4" length	5/8"	11210-1	—
5-1/4" length	5/8"	11211-1	—



11210

Keel Rollers, Heavy-Duty Rubber

These durable, protective rollers are for heavy-duty use. Molded rubber over a steel tube with nylon end inserts. The gradual inward taper and "V" cut eases loading and launching of heavier boats. Plastic inserts are included to protect from mounting hardware damage.

Dimensions	Shaft Diameter	OEM Part #	Part #
8" length	5/8"	11215-1	—
10" length	5/8"	11216-1	—
12" length	5/8"	11217-1	—



11252

Roller Panel Brackets

Cross-member panel brackets are available for a variety of roller sizes. Long mounting slot allows adjustment. Brackets are pre-drilled with 5/8 inch-diameter holes for roller mount. Zinc-plated or galvanized steel.

Width Between Holes	Slots Size	Width Between Slots	OEM Part #	Part #
4-1/4"	2-1/2"	2-3/8"	11252-1	—
8-1/4"	3"	5-1/2"	11254-1	—

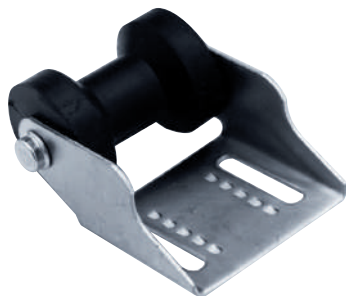

11220

Roller Panel Spool/Keel Bracket Roller Assemblies

Complete spool/keel bracket and roller assembly. Mounts to trailer cross roller assemblies. Formed, zinc-plated steel panel bracket with 1/2 inch-wide slot for adjustment.

Description	Included Parts	OEM Part #	Part #
Spool/keel	11210 roller and 11252 bracket	—	11220-3



11230

Adjusting Rollers, Rubber

For use with automatic adjusting roller systems. Molded rubber. Smooth surface has steel insert; ribbed surface has nylon insert.

- 4-1/4" L x 4-3/8" dia.

Description	Shaft Diameter	OEM Part #	Part #
Smooth	3/4"	11230-1	—



11363

Bunk Brackets

For mounting bunks. Slotted for vertical adjustments. Mounts with 1/2 inch (1.27 cm) bolt. 11-gauge galvanized steel.

Length	Width	OEM #	Part #
8"	2"	11363-1	—
10"	2"	11364-1	—



11360

Swivel Bolster Brackets

Heavy 11-gauge galvanized steel that is slotted for vertical adjustment. Non slip dimples for secure hold. 3.5 inch wide angle bracket pivots for angled or flat mounting of 2 inch x 6 inch bunk or bolster boards. Complete with nut and bolt for angle bracket. Mounts with 1/2 inch bolt.

Size	Assembled	OEM #	Part #
8"	9"	11360-1	—
10"	11"	11361-1	—
12"	13"	11362-1	—



11370

Keel Mounting Bracket

One piece roller bracket with 5 inch slot for vertical adjustment. Mounts with 1/2 inch bolt and is designed to be used with a 5/8 inch roller shaft.

Size	Slot Center	OEM Part #	Part #
5"	2-3/4"	11370-1	—
10"	8-3/16"	11371-1	—
12"	10-1/8"	11372-1	—



11282

Roller Shaft Sets

Roller shafts and matching pal nuts secure shaft in place on roller. Shaft and nuts are solid zinc-plated steel.

Description	Length	Roller Size	OEM Part #	Part #
5/8" dia.	6-3/8"	5-1/4"	—	11282-3
	9-1/4"	8"	—	11283-3
	11-1/4"	10"	—	11284-3
	13-1/2"	12"	—	11285-3



11368

Pal Nuts

5/8 inch zinc plated pal nuts to be used with 5/8 inch roller shafts.

Description	OEM Part #	Part #
Set of 8	—	11368-3



11246

Trailer Bunk Padding

12 ft. long roll of durable, weather-resistant polypropylene marine carpet material. Easy to cut and custom fit. Protects hull; eases loading and launching. Charcoal color; acrylic backing grips surface of trailer bunk boards or cradle. No excessive fuzz, static-free. Made for minimal water retention.

Description	OEM Part #	Part #
8" wide	—	11246-1
12" wide	—	11247-1



11090

Padlock not included

U-Bolt Style Tire Carrier

Square-bend U-bolt with bracket mounts tire on tongue or trailer frame. The frame must be between 2 inch x 2 inch square to 3-1/2 inch x 4 inch rectangular in size. Fits 4- or 5-lug hole rims. Extra-long 8-1/2 inch shaft fits 8 inch to 15 inch tires.

Description	OEM Part #	Part #
Zinc-plated steel	—	11090-3

Transom Savers

We've got you covered

A lifted outboard puts hundreds of foot-pounds of pressure on the transom, especially during trailering.

Protect your boat and engine

- Support the cantilevered weight of the motor
- Stabilize engine and steering mechanism when trailering

The Attwood Difference

- Tough components — You'll get long life from our adjustable toggles with replaceable rubber pads
- Innovation — Our shock absorbing spring-loaded transom saver, is designed to reduce damaging effects of road shock. Works great for motors with hydraulic trim/tilt

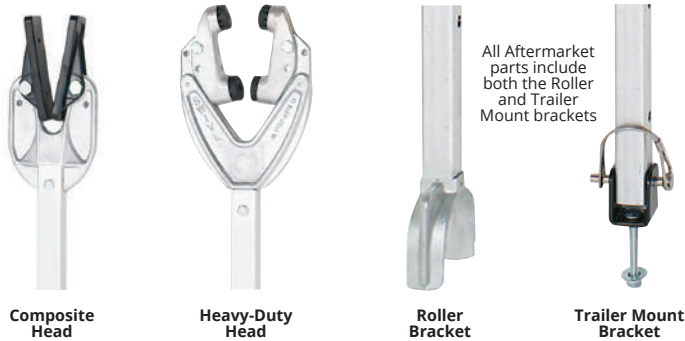
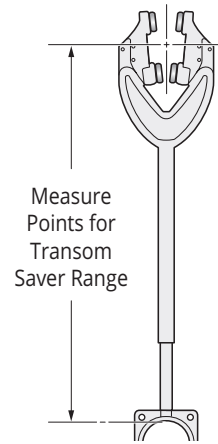

All Aftermarket parts include both the Roller and Trailer Mount brackets

Description	Head Type	Mounting Bracket	OEM Part #	Part #
Adjustable Transom Savers				
23"-35"	Composite	Roller	400-R	—
		Trailer Mount	400-B	—
		Roller/Trailer Mount	—	SP-400-RB
Heavy Duty Transom Savers				
24"-36"	Heavy Duty	Roller	4000-ADJ	—
		Trailer Mount	4000-ADJ-B	—
		Roller/Trailer Mount	—	SP-4000-ADJ-RB
32"-44"	Heavy Duty	Roller	424-ADJ	—
		Roller/Trailer Mount	—	SP-424-ADJ-RB
44"-56"	Heavy Duty	Roller	436-ADJ	—
		Roller/Trailer Mount	—	SP-436-ADJ-RB
Shock Absorbing Transom Savers				
27"-36"	Heavy Duty	Roller/Trailer Mount	—	SP-421-RB
31"-40"	Heavy Duty	Roller/Trailer Mount	—	SP-429-RB
Replacement Parts				
Bolt on Bracket for Attwood Transom Savers			—	SP-402
Replacement Rubber Shocks for Heavy-Duty Head			—	SP-410
Replacement Toggle for Heavy-Duty Head			—	SP-416



Adjustable Transom Saver

Innovative design fits most trailers. Unique angle adjustment (patent pending) from 0 inch to 36 inch with 12 inch increments. Heavy-duty rubber pads and steel construction. Corrosion-resistant, black finish.

Description	Head Type	Mounting Bracket	OEM Part #	Part #
36"-60"	Heavy Duty	Trailer Mount	460-ADJ	—



Lock N' Stow

- Locks outboard motor in forward position while trailering, greatly reducing the damaging effects of road shock
- Doesn't tie engine's lower-unit to trailer, eliminating excessive pressure on hydraulic seals and scuff marks
- Small compact mount can be easily stored in just about any boat compartment
- Constructed of black powder-coated steel with stainless steel pins

Fits:	OEM Part #	Part #
OMC, Bombardier 1989 to present, 100HP and up	—	10309
Mercury engines 200 OptiMax, 255 OptiMax, 225HP EFI, 250HP EFI	—	10107
Mercury engines 135 OptiMax, 150 OptiMax 175 OptiMax, 75HP-200HP EFI	—	10108



Tie-Down Straps

Quick-Release Transom Tie-Down Straps

When properly secured to transom eyes and trailer, transom straps reduce vertical and lateral movement to safely secure the boat to the trailer. They also reduce bouncing of the boat on the trailer pads or rollers. Available in 2 inch width for larger trailerable boats and 1 inch width for lighter boats.

Webbing: Strong webbing. Resists rot, oils, gasoline, and most chemicals.

Buckle: Quick-Release (Over-Center) buckle. Strong and secure, yet easy to use. Quicktightening. Cinch tight and secure by depressing buckle handle. Release by lifting the buckle handle.

Hook: Vinyl-Coated S-Hook to prevent scratching boat or trailer finish. Corrosion-resistant. Heavy-gauge.

Special Features: Protective pad behind buckle to prevent marring and scratches on gel coat and painted surfaces. Hook-N-Loop closure secures the buckle handle in the locked position.

Description	Width	Length	OEM Part #	Part #
One pair	2"	4 ft.	—	15232-7



Quick-Release Buckle with Hook-N-Loop Closure



15232-7

Quick-Release Gunwale Straps

Gunwale straps secure the entire aft section of the boat over the gunwale to the trailer and restrict vertical movement while on the road.

Webbing: Strong webbing. Resists rot, oils, gasoline, and most chemicals.

Buckle: Quick-Release (Over-Center) buckle. Strong and secure, yet easy to use. Quick tightening. Cinch tight and secure by depressing buckle handle. Release by lifting the buckle handle.

Hook: J-Hook with snap-closure for secure, easy attachment. Electrostatic Discharge Coating (EDC) finish to prevent corrosion. Heavy gauge.

Description	Length	OEM Part #	Part #
2" Wide	13 ft.	—	15221-7



15221-7

Marinco® Horns

Marinco is the leading supplier of horns to the marine industry, with over fifty years of experience in designing and manufacturing sound devices specifically for use in harsh marine environments. Stainless steel is used for all critical components such as trumpets, motor cover, diaphragms, and assembly and mounting hardware. In the case of the XLP trumpet horns, the horn is given extra protection through the complete over-molding of the internal motor cover housing. It is this extra process that provides the added protection needed to back up the five-year warranty.

Marinco offers a complete line of marine horn products designed to meet almost any need, including electric and air trumpet horns, compact horns, electric and air below deck horns, and a comprehensive line of drop-in horns with a wide assortment of grill options. After developing the first below deck horn for the marine industry in the late 1980's, the offering of that product line has continued to expand.

- Meets the ABYC Regulation #A23 for boats up to 12 meters
- Meets the U.S. Coast Guard's C.O.L.R.E.G.S. and U.S. Inland Navigation Rules, Annex III Regulations for boats up to 20 meters
- Listed in the NMMA's Certification Program Type Accepted
- Horns are set at a lower frequency to provide greater range as the sound travels across the water

Marinco Horn Relative Loudness Comparison Chart

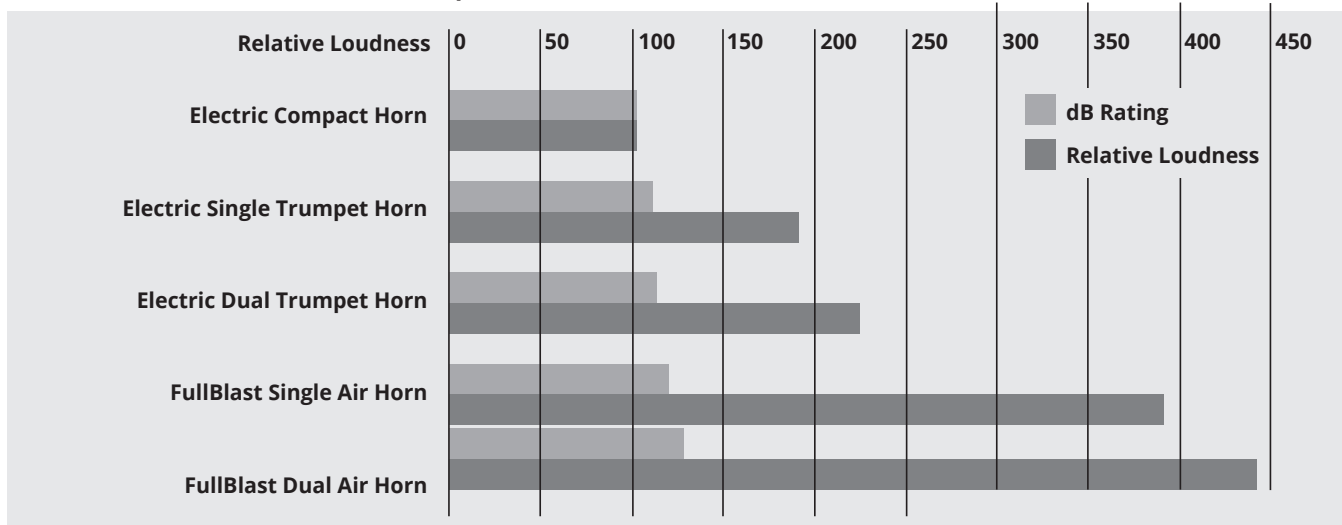

TECH TIP

EMI and Horns

In order to operate, an electric horn rapidly makes and breaks an electric circuit. This operation creates electromagnetic disturbance, which may cause electrical "noise" in communications equipment. Because a horn is only used temporarily, any interference in electronic equipment is stopped when the horn is turned off.

The International Marine Certification Institute (IMCI), which certifies boats to the European Community Regulations (CE), has determined that boats using electric horns can comply with CE requirements on electromagnetic compatibility provided the above message is given to the boat owners in their manual.

Marinco®, the inventor of the first below deck horns, offers a full line of below deck horn products. Concealed horns utilize an upright horn installation and a large grill opening to offer greater sound volume. Drop-in Hidden Horns use a fabric lined grill for water-resistant installations. The concealed trumpet horns are all air horns and provide the maximum amount of sound available in a below deck horn installation.

Marinco’s Drop-in Hidden Horns combine a number of desired features into one unit including:

- Simple, drop-in installation
- Stylish snap-on grill with water-resistant fabric
- Authentic marine sound
- Easy aftermarket retrofit

Important: Please note the space requirement dimensions on some of the below deck models to ensure there is adequate room on the interior of the mounting area to house the horn assembly. Concealed horn models require a minimum 45° mounting angle to ensure proper drainage.

Low Profile Hidden Horn

With Black and White Grills

- New louder dB(A) rating: 111 at one meter
- Fundamental frequency: 360±20Hz
- 12V DC
- Easy installation: 2.75" diameter hole x 1" deep
- Maximum amp draw: 4A
- Comes with both white ASA and black ABS screw-in grills
- Grills have water resistant fabric liners
- Mounts from the outside, grill screws on for easy install
- Easy retrofit



Without Grill

- Same as 10080 without grill
- When purchasing bulk version, grill must be ordered separately



Stainless Steel Grill Cover

- Horizontal style grill design
- Installs over plastic horizontal style grills (11187, 11194, or 11188)
- Installation requires plastic grill
- Grill dimensions: 5.3125" W x 3.4375" H x .875" D
- Kit (includes: stainless steel grill cover and plastic screw-in grill (11187))



TRANSITIONING 2024

	Marinco Part #	Marinco OEM #	Attwood Part #	Attwood OEM #
Horn with Black and White Grills	10080	—	10080-7	—
Horn without grill	—	11080	—	11080-5
Stainless Steel Grill	—	11196	—	11196-5
Stainless Steel Grill Kit	—	11096	—	11096-5

TRANSITIONING 2024

For products with this callout: Jan 1st, 2024, Marinco items will be changing over to Attwood. Same product, but now Attwood branded.

Drop-in Hidden Horns

With Black and White Grills

- dB(A) rating: 107 at one meter
- Fundamental frequency: 370±20Hz
- 12V DC
- Internal space requirements: 2" H x 3.375" W x 3.25" D
- Maximum amp draw: 4A
- Comes with both black ABS and white ASA snap-in grills
- Distinctive marine horn sound
- Enclosed sound unit
- Easy installation or retrofit, mounts from the outside



Enclosed without Grill

- Same as 10079 without grill
- When purchasing 11079, grill must be ordered separately



11079

Without Grill

- dB(A) rating: 105 at one meter
- Fundamental frequency: 430±20Hz
- 12V DC
- Internal space requirements: 2.25" H x 3.625" W x 3.5" D
- Maximum amp draw: 3A
- Mounts from the outside, horn grill snaps on for easy installation
- Easy retrofit
- Grill must be ordered separately

((Lower Frequency
for a Deeper Sound))



11095

Grills for Drop-in Hidden Horns

- Water resistant fabric liner
- 4" from hole to hole
- Dimensions 5" x 2.625" x .5"



11079SC-B

TRANSITIONING 2024

	Marinco Part #	Marinco OEM #	Attwood Part #	Attwood OEM #
Horn with black and white grills	10079	—	10079-7	—
Horn without grill (enclosed)	—	11079	—	11079-1
Horn without grill	—	11095	—	11095-5
Screw-In black ABS grill	—	11079SC-B	—	11079SC-B-5

TRANSITIONING 2024

For products with this callout: Jan 1st, 2024, Marinco items will be changing over to Attwood. Same product, but now Attwood branded.

Drop-In Hidden Horn

Low profile drop-in horn with grills. Design allows easy installation. Easily retrofitted. Comes with black and white cover. 12V DC. ABYC compliant with A-16 standards.

- Includes black and white cover

OEM Part #	Part #
—	11478-7

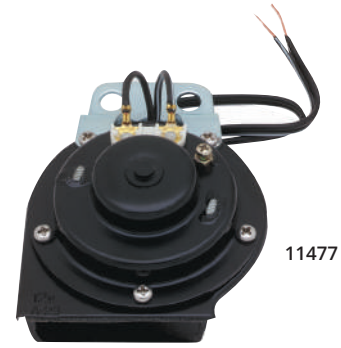

Hidden Horn Kit

Mounts below deck, behind dash, or behind console. Meets ABYC standards for boats up to 16.4 ft. (5 meters), and USCG standards for boats up to 39.4 ft. (12 meters). Heavy-duty marine construction. For 12V DC systems only.

- 3" L x 3 1/4" W x 1 3/4" D

OEM Part #	Part #
—	11477-3



Mini Hidden Horn

- dB(A) rating: 105 at one meter
- Fundamental frequency: 430±20Hz
- 12V DC
- Dimensions: 3.25" W x 1.75" H x 3" L
- Maximum amp draw: 3A
- Type 304 stainless steel diaphragm
- This horn is not designed for installation in exposed areas

((Lower Frequency))
((for a Deeper Sound))



With Grill Bracket

- Same horn motor as 11031 but includes grill mounting bracket
- Grill must be ordered separately



Grills for Mini Hidden Horn 11034

- Screw-In
- Black ABS version includes gasket for watertight seal
- 4" from hole to hole
- Dimensions: 5" x 2.625" x .375" (black), 5" x 2" x .25" (stainless steel)



TRANSITIONING 2024

	Marinco Part #	Marinco OEM #	Attwood Part #	Attwood OEM #
Mini Hidden Horn	10031	11031	10031-7	11031-5
Horn with grill bracket	—	11034	—	11034-5
Screw-In black ABS grill	—	11168	—	11168-5
Screw-In stainless steel grill	—	11088	—	11088-5

TRANSITIONING 2024

For products with this callout: Jan 1st, 2024, Marinco items will be changing over to Attwood. Same product, but now Attwood branded.

Electronic Horn

With White Grill

- 107 dB(A) at one meter
- Fundamental frequency: 550±100Hz
- 12V DC
- Internal space requirements: 2.25" W x 2.25" H x 2" D
- Grill dimensions: 4.875" W x 2.75" H x .5"D
- Draws less than one amp, maximum draw: 0.8A
- Electronic piezo horn sound
- One piece water resistant housing, grill is molded to horn
- Mounts in a standard 2.25" opening
- Stainless steel grill cover 11185 sold separately

Stainless Steel Grill Cover for Electronic Horn 10082

- Grill dimensions: 4.9375" W x 2.8125" H x .5" D
- 4" from hole to hole

TRANSITIONING 2024

	Marinco Part #	Marinco OEM #	Attwood Part #	Attwood OEM #
Horn with white grill	10082	—	10082-7	—
Stainless steel grill	—	11185	—	11185-5



TRANSITIONING 2024

Starting Jan 1st 2024, select Marinco items will become Attwood branded. Same great product, but now available through Attwood.



MiniBlast™ Compact Electric Horns

- dB(A) rating: 106 at one meter (3 feet)
- Fundamental frequency: 430±20Hz
- 12V DC
- Dimensions: 4.375" L x 3.375" W x 2" H
- Maximum amp draw: 3A
- Long lasting, non-corrosive ASA plastic cover
- Sealed sound unit with stainless steel diaphragm
- Mounts in same hole pattern as the 10035 horn

((Lower Frequency for a Deeper Sound))



TRANSITIONING 2024				
	Marinco Part #	Marinco OEM #	Attwood Part #	Attwood OEM #
White Horn	10099	—	10099-7	—
Black Horn	10098	11098	10098-7	11098-5

Mini Compact Electric Horn

- dB(A) rating: 106 at one meter
- Fundamental frequency: 430±20Hz
- 12V DC
- Dimensions: 3" L x 3.25" W x 1.75" H
- Maximum amp draw: 3A
- Totally sealed sound unit
- Type 304 stainless steel cover, diaphragm, mounting bracket

((Lower Frequency for a Deeper Sound))



TRANSITIONING 2024			
Marinco Part #	Marinco OEM #	Attwood Part #	Attwood OEM #
10035	11035	10035-7	11035-5

Mini Twin Electric Horn

- dB(A) rating: 109 at one meter
- Fundamental frequency: 490±20/430±20Hz
- 12V DC
- Dimensions: 3" L x 8" W x 1.75" H
- Maximum amp draw: 6A
- Type 304 stainless steel covers, diaphragms, and mounting bracket

((Lower Frequency for a Deeper Sound))



TRANSITIONING 2024			
Marinco Part #	Marinco OEM #	Attwood Part #	Attwood OEM #
10001	—	10001-7	—

International Shorty Horn

- dB(A) rating: 123 at one meter
- Fundamental frequency: 310±20 Hz
- 12V DC
- Dimensions: 4.25" L x 5" W x 6.5" H
- Maximum amp draw: 4A
- Stainless steel diaphragm and mounting bracket
- ABS, triple chrome-plated housing



TRANSITIONING 2024			
Marinco Part #	Marinco OEM #	Attwood Part #	Attwood OEM #
10036	—	10036-7	—

TRANSITIONING 2024
 Starting Jan 1st 2024, select Marinco items will become Attwood branded. Same great product, but now available through Attwood.

Single Trumpet Electric Horn

5 YEAR WARRANTY

- dB(A) rating: 118 at one meter
- Fundamental frequency: 370±20Hz
- Dimensions: 16.5" L x 4" W x 4.75" H
- Maximum amp draw: 5A
- 100% stainless steel exterior
- Type 304 stainless steel diaphragm
- 24V max amp draw: 2.5A

TRANSITIONING 2024

	Marinco Part #	Marinco OEM #	Attwood Part #	Attwood OEM #
12V	10028XLP	11028XLP	10028XLP-7	11028XLP-1
24V	10017XL	11017XLP	10017XL-7	11017XLP-1



((Lower Frequency))
for a Deeper Sound))

Dual Trumpet Electric Horn

5 YEAR WARRANTY

- dB(A) rating: 123 at one meter
- Fundamental frequency: 370±20/310±20Hz
- Dimensions: 18.5" L x 8" W x 5" H
- Maximum amp draw: 10A
- 100% stainless steel exterior
- Type 304 stainless steel diaphragm
- 24V max amp draw: 2.5A

TRANSITIONING 2024

	Marinco Part #	Marinco OEM #	Attwood Part #	Attwood OEM #
12V	10029XLP	11029XLP	10029XLP-7	11029XLP-1
24V	10018XL	11018XLP	10018XL-7	11018XLP-1

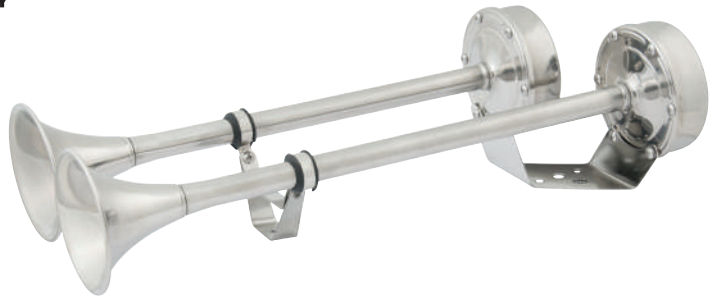

Compact Single Trumpet Electric Horn

- dB(A) rating: 110 at one meter
- Fundamental frequency: 420±20Hz
- 12V DC
- Dimensions: 14" L x 3.5" W x 4" H
- Maximum amp draw: 3.5A
- Compact design makes it easier to install in smaller spaces
- 100% stainless steel exterior
- Type 304 stainless steel diaphragm

TRANSITIONING 2024

Marinco Part #	Marinco OEM #	Attwood Part #	Attwood OEM #
10010	—	10010-7	—



((Lower Frequency))
for a Deeper Sound))

Compact Dual Trumpet Electric Horn

- dB(A) rating: 115 at one meter
- Fundamental frequency: 420±20/370±20Hz
- 12V DC
- Dimensions: 16" L x 7.5" W x 4" H
- Maximum amp draw: 7A
- Compact design makes it easier to install in smaller spaces
- 100% stainless steel exterior
- Type 304 stainless steel diaphragm

TRANSITIONING 2024

Marinco Part #	Marinco OEM #	Attwood Part #	Attwood OEM #
10011	—	10011-1	—



TRANSITIONING 2024

Starting Jan 1st 2024, select Marinco items will become Attwood branded. Same great product, but now available through Attwood.

All of our air horns produce sound levels ranging between 120dB and 127dB, which means all of our air horns meet the ABYC and NMMA regulations for boats up to 20 meters/66 feet. Both 12V and 24V compressors are CE listed.

Single Trumpet Mini Air Horns

- dB rating: 126 at one meter, 1/3 octave band
- Fundamental frequency: 630±15Hz
- Dimensions: 9.5" L x 3.5" W x 3.5" H
- Maximum amp draw: 20A (12V DC)
- Solid brass construction with non-corrosive LEXAN® polycarbonate diaphragm
- Includes compressor, air tubing, fittings, and hardware

TRANSITIONING 2024

	Marinco Part #	Marinco OEM #	Attwood Part #	Attwood OEM #
Chrome Plated	10107	11107	10107-1	11107-1
White Epoxy Coated	10104	—	10104-1	—



Air Compressor included

Dual Trumpet Mini Air Horns

- dB(A) rating: 127 at one meter, 1/3 octave band
- Fundamental frequency: 630±15/525±15Hz
- Dimensions: 9.5" L x 5" W x 3.75" H
- Maximum amp draw: 20A (12V DC)
- Solid brass construction with non-corrosive LEXAN® polycarbonate diaphragm
- Includes compressor, air tubing, fittings, and hardware

TRANSITIONING 2024

	Marinco Part #	Marinco OEM #	Attwood Part #	Attwood OEM #
Chrome Plated	10108	—	10108-1	—



Air Compressor included

Single Trumpet Air Horns

- dB rating: 120 at one meter, 1/3 octave band
- Fundamental frequency: 315±15Hz
- Dimensions: 17" L x 3.75" W x 3.75" H
- Maximum amp draw: 20A (12V DC), 10A (24V DC)
- Solid brass construction with non-corrosive LEXAN® polycarbonate diaphragm
- Includes compressor, air tubing, fittings, and hardware

TRANSITIONING 2024

	Marinco Part #	Marinco OEM #	Attwood Part #	Attwood OEM #
12V	10105	—	10105-1	—
24V	10524	—	10524-1	—



Air Compressor included

Dual Trumpet Air Horns

- dB rating: 121 at one meter, 1/3 octave band
- Fundamental frequency: 375±15/315±15Hz
- Dimensions: 17" L x 7" W x 3.75" H
- Maximum amp draw: 20A (12V DC), 10A (24V DC)
- Solid brass construction with non-corrosive LEXAN® polycarbonate diaphragm
- Includes compressor, air tubing, fittings, and hardware

TRANSITIONING 2024

	Marinco Part #	Marinco OEM #	Attwood Part #	Attwood OEM #
12V, Chrome Plated	10106	11106	10106-1	11106-1
12V, White Epoxy Coated	10122	—	10122-1	—
24V, Chrome Plated	10624	—	10624-1	—

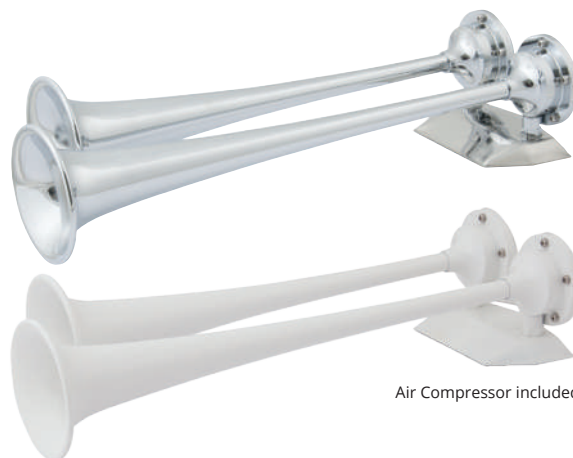

Air Compressor included

TRANSITIONING 2024

Starting Jan 1st 2024, select Marinco items will become Attwood branded. Same great product, but now available through Attwood.

LEXAN® is a registered trademark of Sabic Innovative Plastics IP B.V., Netherlands

Concealed Single Mini Air Horn

- dB rating: 126 at one meter, 1/3 octave band
- Fundamental frequency: 630±15Hz
- 12V DC
- Internal space requirements: 13" H x 5" W x 3.75" D
- Air compressor dimensions: 2.625" D x 5" L
- Maximum amp draw: 20A
- Solid brass construction
- Includes compressor, air tubing, fittings, and hardware
- Grill must be ordered separately



Stainless Steel Grill for 11059

- Dimensions: 4.6875" H x 4.6875" W

TRANSITIONING 2024

	Marinco Part #	Marinco OEM #	Attwood Part #	Attwood OEM #
Concealed Single Mini Air Horn	—	11059	—	11059-1
Stainless Steel Grill for 11059	—	11064	—	11064-1



Concealed Dual Trumpet Air Horn

- dB rating: 121 at one meter, 1/3 octave band
- Fundamental frequency: 375±15/315±15Hz
- 12V DC
- Internal space requirements: 10" W x 18.5" H x 3.75" D
- Air compressor dimensions: 5" L x 2.625" D
- Maximum amp draw: 20A
- Solid brass construction
- Can be mounted side by side with dual grill 11066 or separately with two single grills 11064
- Includes compressor, air tubing, fittings, and hardware



Stainless Steel Grill for 11058

- Dimensions: 9.375" W x 4.6875" H

TRANSITIONING 2024

	Marinco Part #	Marinco OEM #	Attwood Part #	Attwood OEM #
Concealed Dual Trumpet Air Horn	—	11058	—	11058-1
Stainless Steel Grill for 11058	—	11066	—	11066-1



Air Compressor

- Replacement compressor fits all Marinco® and AFI™ Air Horns
- Maximum amp draw: 20A (12V DC), 10A (24V DC)
- Produces 9–11 PSI
- Dimensions: 2.625" D x 5" L
- Includes mounting bracket

TRANSITIONING 2024

	Marinco OEM #	Attwood OEM #
12V	10102	10102-1
24V	10224	10224-1



TRANSITIONING 2024

Starting Jan 1st 2024, select Marinco items will become Attwood branded. Same great product, but now available through Attwood.







Wiper Motors

The motor choice is based primarily on the size of the windshield and where the motor is to be installed, either in an exterior or interior location. Marinco motors are split into two categories, Standard and Heavy-Duty with the categories being defined by the power range of the motors. Within the two categories, there are motors designed for interior or protected installations, and motors designed for exterior installations.

The Standard motor category includes the STD and 500, which are all designed for light duty use, defined as being able to drive a 14" arm and a 14" blade.

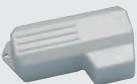
When coverage of a larger windshield is required, Marinco® offers the Heavy-Duty motors, which are capable of driving a wide range of arm and blade sizes, up to a 26" x 26" Deluxe arm and blade combination, which would cover windshields up to 39". The 1000 motor can pull up to a 16" x 16" Deluxe arm and blade combination. The MRV is built for interior or well-protected locations, and has the power to pull a 22" X 22" Deluxe arm and blade combination. The 1.5 motor has the power to pull a 22" x 22" Deluxe arm and blade combination like the MRV, but is waterproof and built for exposed installations.

Choosing the Right Motor

	Model	Voltage	Speeds	Stall Torque/ Stall Current	Compatible Blade Lengths	Available Shaft Lengths	Sweep Angles	Housing
	1.5	12V & 24V	2 speed	109 in-lbs / 11.5A-13A	22" Deluxe 20" Premier	1.5" 2.5"	Factory preset: 80° or 110° Adjustable: 45° or 60°	Fully sealed powder coated aluminum
	3000	12V	2 speed	159 in-lbs / 10.2A-12.2A	26" Deluxe 26" Premier	1.5" 2.5"	Factory preset: 80° or 110° Adjustable to 40°, 50°, 60°, 70°, 80°, 90°, 100° or 110°	Fully sealed aluminum
	1000	12V	Single	55 in-lbs / 9.8A-10A	16" Deluxe 18" Premier	1.5" 2.5"	Factory preset: 65°, 80° or 110° Adjustable: 50°, 65°, 80° or 110°	Fully sealed, UV stabilized hi-temp thermoplastic
	MRV	12V & 24V	2 speed (but can be operated as 1)	109 in-lbs / 11.5A-13A	22" Deluxe 20" Premier (at 80° sweep)	1.5" 2.5" 3.5"	Factory preset: 80° or 110° Adjustable: 45°, 60°, 80° or 110°	Corrosion resistant cast housing
	500	12V	Single	—	14" Deluxe	2.5"	Factory preset: 80° or 110°	Fully sealed, UV stabilized hi-temp thermoplastic
	STD	12V	Single	—	14" Deluxe	2.5" 3.5"	Factory preset: 80° or 110° Adjustable: 80° or 110°	Corrosion proof aluminum alloy case

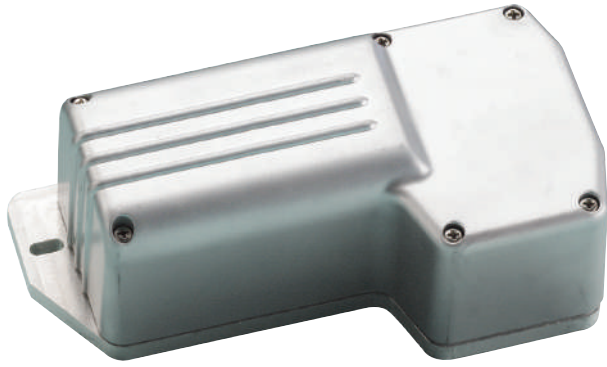

3 YEAR WARRANTY
CE

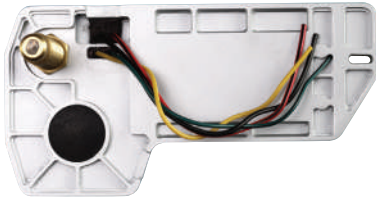

1.5 Waterproof Wiper Motor

- Fully sealed powder coated aluminum waterproof base and housing
- Powers a 22" Deluxe arm and 22" Deluxe blade combination or a 20" Premier arm and 20" Deluxe blade combination
- Available in three (3) shaft lengths: 1.5" and 2.5" (includes .5" length of knurled arm fitting)
- Factory pre-set sweep angles of 80° or 110°, with easy adjustment to 45° or 60°
- Chrome plated solid brass knurled drive nut with brass and stainless steel drive shaft
- Two-speed motor
- Sealed 6" wire leads, 16 AWG
- Adjustable right or left self parking
- .625" diameter shaft (16 mm)
- Available in 12V
- Coast to park
- RF shielded circuitry
- Retail version includes 5A fuse and holder (operating switch not included)
- Measures approximately 7.75" L x 4" W x 2.75" D (see below for detailed dimensional drawings)
- Stall torque: 109 in-lbs (125 kgf/cm; 12.3 Nm)
- Stall current: 11.5A-13.0A
- No load current: 0.5A-1.2A
- Replaces AFI 2000 motor

Related Products



Intermittent Wiper Motor Controller page 177

TRANSITIONING 2024

Description	Voltage	Sweep	Marinco Part #	Marinco OEM #	Attwood Part #	Attwood OEM #
1.5" Shaft	12V	80°	71081	—	71081-1	—
		110°	71011	—	71011-1	—
2.5" Shaft	12V	80°	71082	71182	71082-1	71182-1
		110°	71012	—	71012-1	—

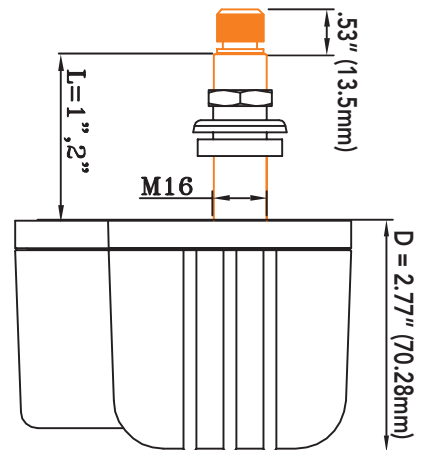
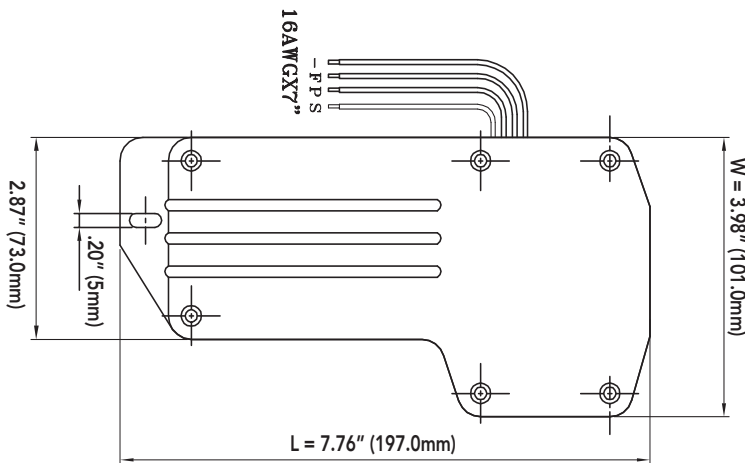

TRANSITIONING 2024

Starting Jan 1st 2024, select Marinco items will become Attwood branded. Same great product, but now available through Attwood.



3 YEAR WARRANTY
CE

3000 Waterproof Wiper Motor

- Fully sealed powder coated aluminum waterproof base and housing
- Powers a 26" Deluxe arm and Deluxe blade combination or a 24" Premier arm and Deluxe blade combination
- Available in two (2) shaft lengths: 1.5" and 2.5" (includes .5" length of knurled arm fitting)
- .625" diameter shaft (16 mm)
- Factory preset sweep angles of 80° or 110°, with easy adjustment from 40° to 110° at 10° increments
- Sealed 6" wire leads, 16 AWG
- Adjustable right or left self parking
- Two-speed settings
- Retail version includes 5A fuse and holder (on/off switch not included)
- Isolated ground
- Stall torque: 159 in-lbs (183 kgf/cm; 18 Nm)
- Stall current: 10.2A-12.20A
- IP66 rated (see inside back cover)

TRANSITIONING 2024

Description	Voltage	Sweep	Marinco Part #	Marinco OEM #	Attwood Part #	Attwood OEM #
1.5" Shaft	12V	80°	83081	83181	83081-1	83181-1
		110°	83011	83111	83011-1	83111-1
2.5" Shaft	12V	80°	83082	83182	83082-1	83182-1
		110°	83012	83112	83012-1	83112-1

Related Products



Intermittent Wiper Motor Controller
 page 177

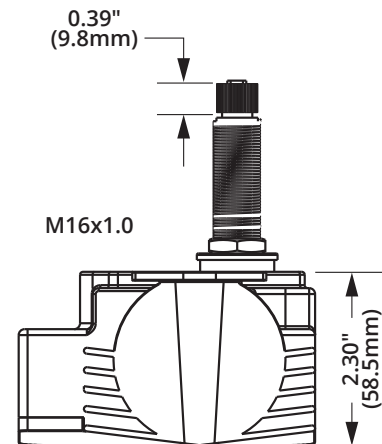
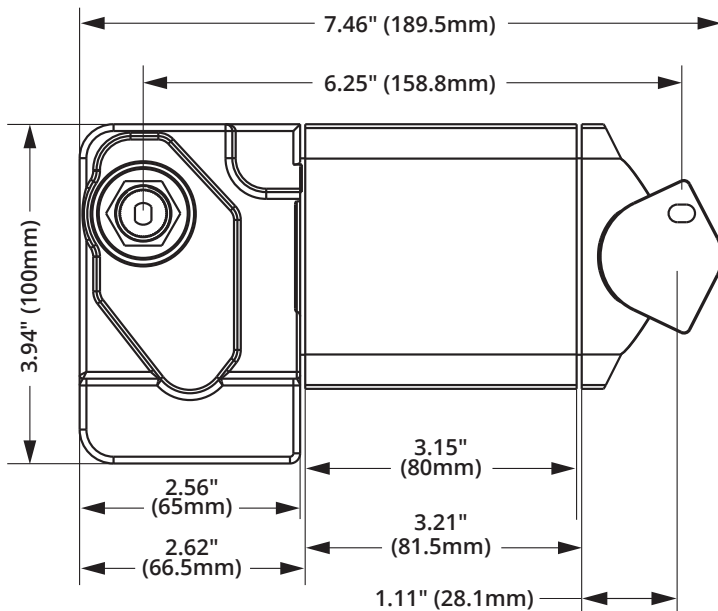

TRANSITIONING 2024

Starting Jan 1st 2024, select Marinco items will become Attwood branded. Same great product, but now available through Attwood.



3 YEAR WARRANTY
CE

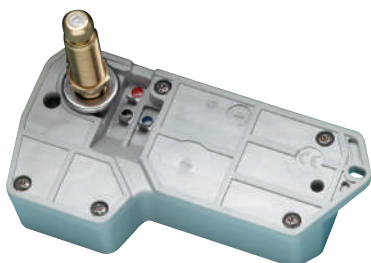

1000 Waterproof Wiper Motor

- Powers 18" Deluxe arm and 18" Deluxe blade combination at sweep sets of 80° or less (not compatible with pantograph arms)
- Powers 16" Deluxe arm and 16" Deluxe blade combinations at a sweep set of 110° (not compatible with pantograph arms)
- Factory pre-set sweep of 80° or 110° adjustable to 50°, 65°, 80°, or 110°
- .625" diameter shaft (16 mm)
- Fully sealed waterproof housing made of UV stabilized, high-temperature, high-impact thermoplastic
- 12V heavy-duty motor with anti-rotation drive shaft
- Knurled drive shaft and solid brass arm drive nut
- Coast to park with adjustable right or left self parking
- Retail version includes 5A fuse and holder (on/off switch not included)
- RF shielded circuitry
- Weight: 1.75 lbs
- Available in two (2) shaft lengths: 1.5" and 2.5" (includes .5" length of knurled arm fitting)
- Measures approximately 6.625" L x 3.375" W x 2" D
- Stall torque: 55 in-lbs (63 kgf/cm; 6.2 Nm)
- Stall current: 9.8A-10.0A
- No load current: 0.8A-1.2A

Related Products



Intermittent Wiper Motor Controller
 page 177

TRANSITIONING 2024

Description	Voltage	Sweep	Marinco Part #	Marinco OEM #	Attwood Part #	Attwood OEM #
1.5" Shaft	12V	65°	—	36161	—	36161-1
		80°	36180	—	36180-1	—
		110°	36110	36111	36110-1	36111-1
2.5" Shaft	12V	65°	—	37161	—	37161-1
		80°	37180	37181	37180-1	37181-1
		110°	37110	37111	37110-1	37111-1
2.5" Shaft Kits	12V	80°	37100	—	37100-1	—
		110°	37200	—	37200-1	—

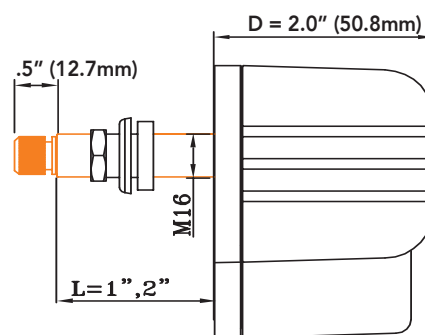
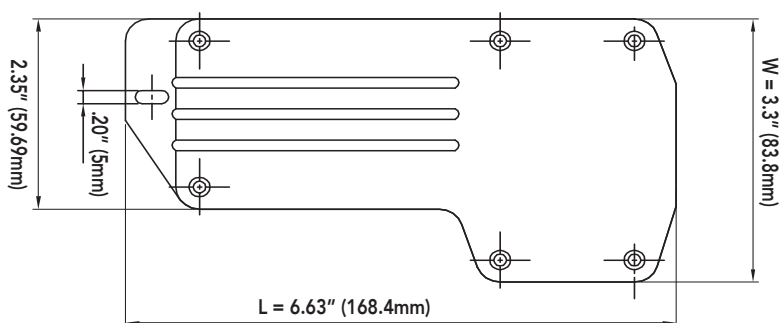

TRANSITIONING 2024

Starting Jan 1st 2024, select Marinco items will become Attwood branded. Same great product, but now available through Attwood.



3 YEAR WARRANTY
CE

MRV Wiper Motor

- Easily powers 22" x 22" deluxe arm/blade combinations, or a 20" x 20" premier arm/blade combination at sweep sets of 80° or less
- Factory pre-set sweep of 80° or 110° adjustable from 40° to 110° in 10° increments
- .625" diameter shaft (16 mm)
- Available in three (3) shaft lengths: 1.5", 2.5" and 3.5" (includes .5" length of knurled arm fitting)
- Corrosion-resistant casing
- Heavy-duty motor with right angle drive
- Two-speed motor, can be operated as one speed
- Solid brass knurled drive nut with brass and stainless steel drive shaft
- Adjustable right or left self parking, coast to park
- Retail version includes 5A fuse and holder
- Stainless steel fasteners and mounting bracket
- Use with three-position switch (not included)
- Compact size – 7.625" L x 4" W x 2" D
- Stall torque: 109 in-lbs (125 kgf/cm: 12.3 Nm)
- Stall current: 11.5A-13.0A
- No load current: 0.5A-1.2A

Related Products



Intermittent Wiper Motor Controller
 page 177

TRANSITIONING 2024

Description	Voltage	Sweep	Marinco Item#	Marinco OEM #	Attwood Item#	Attwood OEM #
1.5" Shaft	12V	80°	34001	38001	34001-1	38001-1
		110°	34011	38011	34011-1	38011-1
2.5" Shaft	12V	80°	34000	38000	34000-1	38000-1
		110°	34010	38010	34010-1	38010-1
		24V	110°	34210	—	34210-1
3.5" Shaft	12V	80°	34005	38005	34005-1	38005-1
		110°	34015	—	34015-1	—

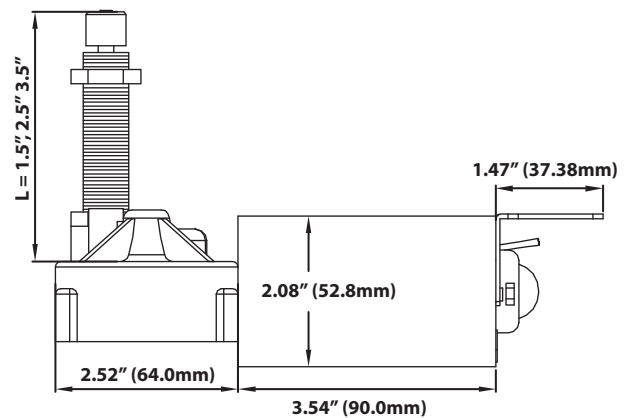
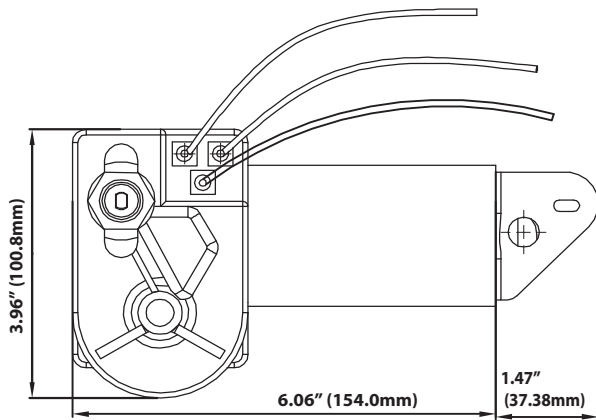

MRV Wiper Motor Cover

- Constructed of white ABS plastic
- Easily installed

TRANSITIONING 2024

Description	Marinco Part #	Marinco OEM #	Attwood Part #	Attwood OEM #
White	33025	33125	33025-5	33125-5

TRANSITIONING 2024

Starting Jan 1st 2024, select Marinco items will become Attwood branded. Same great product, but now available through Attwood.



3 YEAR WARRANTY

STD Wiper Motor

Windshield Mount: .375" shaft diameter

Deck Mount: .5" shaft diameter

- Deck mount version includes deck mount adapter kit (33000)
- Powers up to 14" x 14" arm/blade combinations
- Corrosion-proof aluminum alloy case with black crackle finish
- Base & mounting plates are chrome plated naval brass
- Maximum current draw: 2A
- 80° or 110° adjustable sweep, adjustable right or left self-parking
- Shaft diameter: .375" windshield mount, .5" deck mount
- Dimensions: 3.875" L x 2.25" W x 3.5" D

TRANSITIONING 2024

Description	Voltage	Sweep	Marinco Part #	Attwood Part #
2.5" Shaft	12V	80°	35040	35040-1



3 YEAR WARRANTY

STD Wiper Motor Kit

Windshield Mount: .375" shaft diameter

Deck Mount: .5" shaft diameter

- Deck Mount version includes deck mount adapter kit (33000)
- Powers up to 14" x 14" arm/blade combinations
- Corrosion-proof aluminum alloy case with black crackle finish
- Base & mounting plates are chrome plated naval brass
- Maximum current draw: 2A
- 80° or 110° adjustable sweep, adjustable right or left self-parking
- Shaft diameter: .375" windshield mount, .5" deck mount
- Dimensions: 3.875" L x 2.25" W x 3.5" D

Kit includes:

- STD wiper motor (recommended for interior installations only)
- 11.5" Deluxe stainless steel curved blade (33004)
- Deluxe adjustable (6.75" to 10.5") stainless steel arm (33006AS)

TRANSITIONING 2024

Description	Voltage	Sweep	Marinco OEM #	Attwood OEM #
2.5" Shaft	12V	80°	32000	32000-7
		110°	32002	32002-7
3.5" Shaft	12V	80°	32001	32001-7



3 YEAR WARRANTY

500 Wiper Kit

Windshield Mount: .5" shaft diameter

Kit includes:

- 500 Waterproof wiper motor
- 11.5" Deluxe stainless steel curved blade (33004)
- Deluxe adjustable (6.75" to 10.5") stainless steel arm (33006AS)

TRANSITIONING 2024

Description	Voltage	Sweep	Marinco OEM #	Attwood OEM #
2.5" Shaft	12V	80°	30004	30004-7
2.5" Shaft	12V	110°	30005	30005-7



Hand-operated Wiper Blade

- Chrome-plated brass handle
- Includes stainless steel 7-1/2" to 12" adjustable wiper arm, 11" blade, and all parts for installation
- Economical—an inexpensive alternative to wiper motor kit
- Requires 7/16" diameter hole for installation
- Can be installed up to 7/8" thick material
- For use on flat windshields only

TRANSITIONING 2024

Description	Marinco Part #	Marinco OEM #	Attwood Part #	Attwood OEM #
Full Kit	31000	—	31000-5	—
Replacement Blade	—	33101	—	33101-5

TRANSITIONING 2024

Starting Jan 1st 2024, select Marinco items will become Attwood branded. Same great product, but now available through Attwood.

Intermittent Wiper Motor Controller

- Single-speed and dual-speed options
- Allows for the control of single motor systems, and synchronized control of dual motor systems
- Intuitive automotive-style functionality—features adjustable intermittent settings, adjustable continuous settings, and washer system operation
- IP67—Potted case for harsh environment durability (see inside back cover)
- Includes Contura Switch, SPDT (On)-Off-(On) (retail only)
- Easy to install with 1/4" spade connectors
- Reverse polarity protection
- Compatible with 12V and 24V DC motors

TRANSITIONING 2024

Description	Marinco Part #	Marinco OEM #	Attwood Part #	Attwood OEM #
Single Speed	76090	76190	76090-3	76190-6
Dual Speed	76080	76180	76080-3	76180-6

LEARN MORE
Wiper Motor
Controller Video



Visit Marinco on
YouTube.com



76080



Wiper Arms

Wiper arms are available in Deluxe and Premier styles and the primary construction material in all wiper arms is stainless steel. The Deluxe arms are used on Standard and Heavy-Duty motors. When choosing arms (and blades) it is very important to use only the recommended lengths for the motor that you are using.

The arms are available in a wide range of sizes, in both black and stainless-steel finish, and regular and pantographic models. Pantographic arms use a set of two arms joined together to give a flatter and somewhat wider sweep pattern. The Deluxe arms are available in a polished stainless-steel finish or a black powder-coated finish. Premier arms are the top of the line product in this category, utilizing heavy-duty stainless-steel tubing and components, and they can only be used with the Heavy-Duty motors.

Premier arms are also available as “wet arm” versions, with the water hose and sprayer nozzle built into the wiper arm. All that is needed is a water delivery system that the arm can be tied into. For those wanting a windshield washer system for the Deluxe arms, there is a complete washer kit system that is made especially to fit the Deluxe arms.

Wiper Arm Compatibility Chart

Style	Wet/ Dry	Length (adjustable)	Color	Material	Part #	OEM #	Motor Compatibility Chart				
							2.5	3000	1.5	1000	MRV
Premier											
single	wet	15"-20"	stainless	stainless	33084W	33184W	✓	✓	✓	—	✓
single	wet	20"-25"	stainless	stainless	33086W	33186W	✓	✓	—	—	—
pantographic	dry	12"-17"	stainless	stainless	33090	33190	✓	✓	✓	—	✓
pantographic	dry	17"-22"	stainless	stainless	33092	33192	✓	✓	—	—	max 20"
pantographic	dry	22"-26"	stainless	stainless	33094	33194	✓	✓	—	—	—
pantographic	wet	12"-17"	stainless	stainless	33090W	—	✓	✓	✓	—	✓
pantographic	wet	17"-22"	stainless	stainless	33092W	33192W	✓	✓	—	—	max 20" ≤ 80"
Deluxe Adjustable											
single	dry	6.75"-10.5"	stainless	stainless	33006A	33106A	✓	✓	✓	✓	✓
single	dry	10"-14"	stainless	stainless	33007A	33107A	✓	✓	✓	✓	✓
single	dry	14"-20"	stainless	stainless	33010A	33110A	✓	✓	✓	max 18" ≤ 80° max 16" @ 110°	✓
single	dry	10"-14"	black	stainless	33012A	33112A	✓	✓	✓	✓	✓
single	dry	14"-20"	black	stainless	33014A	33114A	✓	✓	✓	max 18" ≤ 80° max 16" @ 110°	✓
single	dry	18"-24"	black	stainless	33070A	33170A	✓	✓	—	—	max 22"
Deluxe Pantographic											
pantographic	dry	12"-17"	black	stainless	33032A	33132A	✓	✓	✓	—	✓
pantographic	dry	17"-22"	black	stainless	33037A	33137A	✓	✓	✓	—	✓

Premier Stainless Steel Pantographic Dry Arms

- Heavy-duty component design for use with most Marinco® motors
- Stainless steel construction
- Features “articulating/bend back” design that locks arm in upright position for windshield cleaning
- Motor shaft mount with notched teeth



Pantographic

Style	Wet/Dry	Length (adjustable)	Color	Material	TRANSITIONING 2024			
					Marinco Part #	Marinco OEM #	Attwood Part #	Attwood OEM #
pantographic	dry	12"-17"	stainless	stainless	33090	33190	33090-5	33190-5
pantographic	dry	17"-22"	stainless	stainless	33092	33192	33092-5	33192-5
pantographic	dry	22"-26"	stainless	stainless	33094	33194	33094-5	33194-5

Pantographic wiper arms will only function properly with wiper motor sweep angles 80° or less

TRANSITIONING 2024

Starting Jan 1st 2024, select Marinco items will become Attwood branded. Same great product, but now available through Attwood.

Premier Stainless Steel Wiper Wet Arms

- Heavy-duty component design for use with most Marinc® motors
- Features “articulating/bend back” design that locks arm in upright position for windshield cleaning
- Built-in wet arm system that allows for a clean and easy installation of a washer system
- Black PVC hose runs up the center of the arm and ends in an adjustable four-nozzle fixture that is an integral part of the wiper arm itself



TRANSITIONING 2024

Style	Wet/Dry	Length (adjustable)	Color	Material	Marinco Part #	Marinco OEM #	Attwood Part #	Attwood OEM #
single	wet	15"-20"	stainless	stainless	33084W	33184W	33084W-5	33184W-5
single	wet	20"-25"	stainless	stainless	33086W	33186W	33086W-5	33186W-5
pantographic	wet	17"-22"	stainless	stainless	33092W	33192W	33092W-5	33192W-5

Pantographic wiper arms will only function properly with wiper motor sweep angles 80° or less

Deluxe Adjustable Wiper Arm

- All arms are stainless steel
- Arm has “articulating/bend-back” feature
- Motor shaft mounting has additional set screw clamping



TRANSITIONING 2024

Style	Wet/Dry	Length (adjustable)	Color	Material	Marinco Part #	Marinco OEM #	Attwood Part #	Attwood OEM #
single	dry	6.75"-10.5"	stainless	stainless	33006A	33106A	33006A-7	33106A-5
single	dry	10"-14"	stainless	stainless	33007A	33107A	33007A-7	33107A-5
single	dry	14"-20"	stainless	stainless	33010A	33110A	33010A-7	33110A-5
single	dry	10"-14"	black	stainless	33012A	—	33012A-7	—
single	dry	14"-20"	black	stainless	33014A	33114A	33014A-7	33114A-5
single	dry	18"-24"	black	stainless	33070A	33170A	33070A-7	33170A-5

Deluxe Adjustable Pantographic Arm

- For Use with 2.5, 1.5 and MRV Motors
- Stainless steel
- Arm has “articulating/bend-back” feature
- Motor shaft mounting has additional set screw clamping



TRANSITIONING 2024

Style	Wet/Dry	Length (adjustable)	Color	Material	Marinco Part #	Marinco OEM #	Attwood Part #	Attwood OEM #
pantographic	dry	12"-17"	black	stainless	33032A	33132A	33032A-7	33132A-5
pantographic	dry	17"-22"	black	stainless	33037A	33137A	33037A-7	33137A-5

TRANSITIONING 2024

Starting Jan 1st 2024, select Marinc items will become Attwood branded. Same great product, but now available through Attwood.

Wiper Blade Selection Charts

Step 1: Find the type and part number of wiper arm you have along the left side of the chart.

Step 2: Follow along to the right until you match up with the type and length of wiper blade you want.

Step 3: The bold number is the part number and the lighter number is the OEM number (if available).



	Color/ Material	Length	Deluxe Blades							Black/ Stainless					
			Stainless/ Stainless	12"	14"	16"	18"	20"	22"	24"	26"	12"	14"	16"	18"
Premier Wiper Arms	Single Arm														
	33084W 33184W	wet	34012S 34112S	34014S 34114S	34016S 34116S	34018S 34118S	34020S 34120S	34022S 34122S	34024S 34124S	34026S 34126S	34012B 34112B	34014B 34114B	34016B 34116B	34018B 34118B	
	33086W 33186W	wet	34012S 34112S	34014S 34114S	34016S 34116S	34018S 34118S	34020S 34120S	34022S 34122S	34024S 34124S	34026S 34126S	34012B 34112B	34014B 34114B	34016B 34116B	34018B 34118B	
	Pantograph Arm														
	33090 33190	dry	34012S 34112S	34014S 34114S	34016S 34116S	34018S 34118S	34020S 34120S	34022S 34122S	34024S 34124S	34026S 34126S	34012B 34112B	34014B 34114B	34016B 34116B	34018B 34118B	
	33090W 33190W	wet	34012S 34112S	34014S 34114S	34016S 34116S	34018S 34118S	34020S 34120S	34022S 34122S	34024S 34124S	34026S 34126S	34012B 34112B	34014B 34114B	34016B 34116B	34018B 34118B	
	33092 33192	dry	34012S 34112S	34014S 34114S	34016S 34116S	34018S 34118S	34020S 34120S	34022S 34122S	34024S 34124S	34026S 34126S	34012B 34112B	34014B 34114B	34016B 34116B	34018B 34118B	
	33092W 33192W	wet	34012S 34112S	34014S 34114S	34016S 34116S	34018S 34118S	34020S 34120S	34022S 34122S	34024S 34124S	34026S 34126S	34012B 34112B	34014B 34114B	34016B 34116B	34018B 34118B	
	33094 33194	dry	34012S 34112S	34014S 34114S	34016S 34116S	34018S 34118S	34020S 34120S	34022S 34122S	34024S 34124S	34026S 34126S	34012B 34112B	34014B 34114B	34016B 34116B	34018B 34118B	
	33094W 33194W	wet	34012S 34112S	34014S 34114S	34016S 34116S	34018S 34118S	34020S 34120S	34022S 34122S	34024S 34124S	34026S 34126S	34012B 34112B	34014B 34114B	34016B 34116B	34018B 34118B	
	Deluxe Wiper Arms	Single Arm													
		33006A 33106A	dry	34012S 34112S	34014S 34114S	34016S 34116S	34018S 34118S	34020S 34120S	34022S 34122S	34024S 34124S	34026S 34126S	34012B 34112B	34014B 34114B	34016B 34116B	34018B 34118B
		33007A 33107A	dry	34012S 34112S	34014S 34114S	34016S 34116S	34018S 34118S	34020S 34120S	34022S 34122S	34024S 34124S	34026S 34126S	34012B 34112B	34014B 34114B	34016B 34116B	34018B 34118B
		33010A 33110A	dry	34012S 34112S	34014S 34114S	34016S 34116S	34018S 34118S	34020S 34120S	34022S 34122S	34024S 34124S	34026S 34126S	34012B 34112B	34014B 34114B	34016B 34116B	34018B 34118B
33012A 33112A		dry	34012S 34112S	34014S 34114S	34016S 34116S	34018S 34118S	34020S 34120S	34022S 34122S	34024S 34124S	34026S 34126S	34012B 34112B	34014B 34114B	34016B 34116B	34018B 34118B	
33014A 33114A		dry	34012S 34112S	34014S 34114S	34016S 34116S	34018S 34118S	34020S 34120S	34022S 34122S	34024S 34124S	34026S 34126S	34012B 34112B	34014B 34114B	34016B 34116B	34018B 34118B	
33070A 33170A		dry	34012S 34112S	34014S 34114S	34016S 34116S	34018S 34118S	34020S 34120S	34022S 34122S	34024S 34124S	34026S 34126S	34012B 34112B	34014B 34114B	34016B 34116B	34018B 34118B	
Pantograph Arm															
33032A 33132A		dry	34012S 34112S	34014S 34114S	34016S 34116S	34018S 34118S	34020S 34120S	34022S 34122S	34024S 34124S	34026S 34126S	34012B 34112B	34014B 34114B	34016B 34116B	34018B 34118B	
33037A 33137A		dry	34012S 34112S	34014S 34114S	34016S 34116S	34018S 34118S	34020S 34120S	34022S 34122S	34024S 34124S	34026S 34126S	34012B 34112B	34014B 34114B	34016B 34116B	34018B 34118B	

Pantographic wiper arms will only function properly with wiper motor sweep angles 80° or less

Wiper Blades

Deluxe and Hybrid wiper blades are offered in different sizes and styles to fit all the different types of wiper arms. Standard styles have plastic frame construction and marine grade rubber squeegees.

Deluxe blades have stainless steel frame construction and high-end silicone rubber squeegees. This style has a multiple frame construction, allowing for equal pressure of the entire length of the blade and silicone rubber squeegees that are durable and create a smoother wiping motion.

Hybrid blades are designed from a multi-material construction of an electro coated galvanized steel frame, with a durable polycarbonate shell. This along with a graphite-coated natural rubber squeegee make this an excellent marine grade construction. For maximum performance of all blade styles, replacement of wiper blades is recommended every 6 months.



Deluxe Blades (cont)				Hybrid Blades						
Black/Stainless (cont)				Black/Polymer						
20"	22"	24"	26"	12"	14"	16"	18"	20"	22"	24"
34020B 34120B	34022B 34122B	34024B 34124B	34026B 34126B	32012B 32112B	32014B 32114B	32016B 32116B	32018B 32118B	32020B 32120B	32022B 32122B	32024B 32124B
34020B 34120B	34022B 34122B	34024B 34124B	34026B 34126B	32012B 32112B	32014B 32114B	32016B 32116B	32018B 32118B	32020B 32120B	32022B 32122B	32024B 32124B
34020B 34120B	34022B 34122B	34024B 34124B	34026B 34126B	32012B 32112B	32014B 32114B	80° only	80° only	80° only		
34020B 34120B	34022B 34122B	34024B 34124B	34026B 34126B	32012B 32112B	32014B 32114B	80° only	80° only	80° only		
34020B 34120B	34022B 34122B	34024B 34124B	34026B 34126B	32012B 32112B	32014B 32114B	32016B 32116B	32018B 32118B	32020B 32120B	32022B 32122B	80° only
34020B 34120B	34022B 34122B	34024B 34124B	34026B 34126B	32012B 32112B	32014B 32114B	32016B 32116B	32018B 32118B	32020B 32120B	32022B 32122B	80° only
34020B 34120B	34022B 34122B	34024B 34124B	34026B 34126B	32012B 32112B	32014B 32114B	32016B 32116B	32018B 32118B	32020B 32120B	32022B 32122B	32024B 32124B
34020B 34120B	34022B 34122B	34024B 34124B	34026B 34126B	32012B 32112B	32014B 32114B	32016B 32116B	32018B 32118B	32020B 32120B	32022B 32122B	32024B 32124B
34020B 34120B	34022B 34122B	34024B 34124B	34026B 34126B	32012B 32112B	32014B 32114B	32016B 32116B				
34020B 34120B	34022B 34122B	34024B 34124B	34026B 34126B	32012B 32112B	32014B 32114B	32016B 32116B	32018B 32118B	32020B 32120B		
34020B 34120B	34022B 34122B	34024B 34124B	34026B 34126B	32012B 32112B	32014B 32114B	32016B 32116B	32018B 32118B	32020B 32120B	32022B 32122B	32024B 32124B
34020B 34120B	34022B 34122B	34024B 34124B	34026B 34126B	32012B 32112B	32014B 32114B	32016B 32116B	32018B 32118B	32020B 32120B	32022B 32122B	32024B 32124B
34020B 34120B	34022B 34122B	34024B 34124B	34026B 34126B	32012B 32112B	32014B 32114B	32016B 32116B	32018B 32118B	32020B 32120B	32022B 32122B	32024B 32124B
34020B 34120B	34022B 34122B	34024B 34124B	34026B 34126B	32012B 32112B	32014B 32114B	32016B 32116B	32018B 32118B	32020B 32120B	32022B 32122B	32024B 32124B
34020B 34120B	34022B 34122B	34024B 34124B	34026B 34126B	32012B 32112B	32014B 32114B	32016B 32116B	32018B 32118B	32020B 32120B		
34020B 34120B	34022B 34122B	34024B 34124B	34026B 34126B	32012B 32112B	32014B 32114B	32016B 32116B	32018B 32118B	32020B 32120B	32022B 32122B	32024B 32124B

Deluxe Stainless Steel Wiper Blades

- Works well on curved or flat windshields
- All stainless steel construction
- Marine grade silicone squeegee



TRANSITIONING 2024

Length	Color	Material	Marinco Part #	Marinco OEM #	Attwood Part #	Attwood OEM #
12"	stainless	stainless	34012S	34112S	34012S-7	34112S-5
14"	stainless	stainless	34014S	34114S	34014S-7	34114S-5
16"	stainless	stainless	34016S	34116S	34016S-7	34116S-5
18"	stainless	stainless	34018S	34118S	34018S-7	34118S-5

TRANSITIONING 2024

Length	Color	Material	Marinco Part #	Marinco OEM #	Attwood Part #	Attwood OEM #
20"	stainless	stainless	34020S	34120S	34020S-7	34120S-5
22"	stainless	stainless	34022S	34122S	34022S-7	34122S-5
24"	stainless	stainless	34024S	34124S	34024S-7	34124S-5
26"	stainless	stainless	34026S	34126S	34026S-7	34126S-5



TRANSITIONING 2024

Length	Color	Material	Marinco Part #	Marinco OEM #	Attwood Part #	Attwood OEM #
12"	black	stainless	34012B	34112B	34012B-7	34112B-5
14"	black	stainless	34014B	34114B	34014B-7	34114B-5
16"	black	stainless	34016B	34116B	34016B-7	34116B-5
18"	black	stainless	34018B	34118B	34018B-7	34118B-5

TRANSITIONING 2024

Length	Color	Material	Marinco Part #	Marinco OEM #	Attwood Part #	Attwood OEM #
20"	black	stainless	34020B	34120B	34020B-7	34120B-5
22"	black	stainless	34022B	34122B	34022B-7	34122B-5
24"	black	stainless	34024B	34124B	34024B-7	34124B-5
26"	black	stainless	34026B	34126B	34026B-7	34126B-5

Hybrid Wiper Blades

Hybrid Multi-Material Construction. Electro coated galvanized steel frame, with durable polycarbonate shell.

- Designed for maximum flexibility to conform to all windshield shapes
- Marine grade construction will not rust or corrode
- Graphite-coated natural rubber squeegee for optimal wipe quality and durability
- Streamlined shape for reduced wind-lift
- Performance-tested to 500,000 cycles

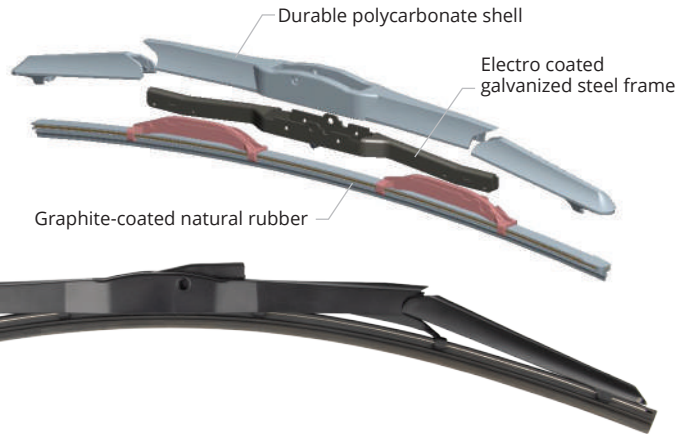

TRANSITIONING 2024

Length	Color	Material	Marinco Part #	Marinco OEM #	Attwood Part #	Attwood OEM #
12"	black	hybrid	32012B	32112B	32012B-7	32112B-5
14"	black	hybrid	32014B	32114B	32014B-7	32114B-5
16"	black	hybrid	32016B	32116B	32016B-7	32116B-5
18"	black	hybrid	32018B	32118B	32018B-7	32118B-5

TRANSITIONING 2024

Length	Color	Material	Marinco Part #	Marinco OEM #	Attwood Part #	Attwood OEM #
20"	black	hybrid	32020B	32120B	32020B-7	32120B-5
22"	black	hybrid	32022B	32122B	32022B-7	32122B-5
24"	black	hybrid	32024B	32124B	32024B-7	32124B-5

Classic Stainless Steel Straight Wiper Blades

- Replaces most standard blades in boats made before 1990
- Hook and catch style



TRANSITIONING 2024

Length	Color	Material	Marinco Part #	Attwood Part #
11"	stainless	stainless	33901	33901-7
14"	stainless	stainless	33919	33919-7

Note: NOT for use with currently offered arms

TRANSITIONING 2024

Starting Jan 1st 2024, select Marinco items will become Attwood branded. Same great product, but now available through Attwood.

Add-On Windshield Washer Kits

- Can be used on new or existing Deluxe wiper arm and blade sets
- Kit includes parts to outfit two (2) wiper arms
- Sprayer fittings (kit includes two) each have four (4) adjustable brass nozzles to provide maximum spray coverage for most any windshield
- Plastic parts are numbered to make installation easy



Complete Kit

Includes:

- Water tank with mounting bracket
- 12V pump motor
- Under deck tee fitting
- Thru deck fitting and hardware
- Below deck clear tubing (16')
- Above deck black tubing (6')
- Large and small rivet clips
- Wiper arm clips
- Sprayer fittings with clamps

Above Deck Kit for One Small Arm

Includes:

- Small rivet clip
- Wiper arm clips
- Sprayer fitting with narrow clamp
- Thru deck fitting
- Above deck black tubing (6')

TRANSITIONING 2024

Description	Marinco Part #	Marinco OEM #	Attwood Part #	Attwood OEM #
Complete Kit	33505	33515	33505-1	33515-1
Above Deck	—	33517	—	33517-1

Intelligent Wiper Switch

Microcontroller based “intelligent” switch provides all necessary wiper motor functions in one small component.

- Settings for two (2) continuous speed functions and three (3) intermittent speed functions (2-, 4-, or 8-second delay)
- Washer system operation function
- Blinking LED lights in switch indicate operating function
- Works with 12V or 24V DC motors
- Fits standard switch size openings, requires 2.65"/67.5 mm depth
- Includes one (1) ten pole connector with female pins and two (2) female quick-connects



TRANSITIONING 2024

Description	Marinco Part #	Marinco OEM #	Attwood Part #	Attwood OEM #
Single Motor	76030	76130	76030-6	76130-6

TRANSITIONING 2024

Starting Jan 1st 2024, select Marinco items will become Attwood branded. Same great product, but now available through Attwood.

HARDWARE

Cleats



186

Attwood provides a variety of durable and attractive cleat options to fit all your docking needs. Select from various finishes that are in tune with styling of today's boats.

Lift Rings, Hawse Pipes & Bow Eyes



191

Lift rings provide heavy duty strength for boats lifted by davits, cranes, or shore stations. Attwood hawse pipes reduce deck and rope chafing when attaching dock lines to cleats. Bow eyes can function as a ski tow when transom-mounted.

Hooks



193

Links, carabines, and hooks are fundamental in boating, providing security and multi-use functionality.

Water Ski Hardware



194

Attwood water ski hardware is ideal for PWCs, I/Os, and inboard ski boats. Constructed of 304 stainless steel for corrosion resistance, smoothed and highly polished for a clean design.



HARDWARE

Bimini Style Convertible Top Accessories



196

For a complete support system, our bimini top fittings offer substantial protection and security.

Hinges



197

Attwood hinges provide the support and stability needed for a smooth operation of your vessel.

Hatch & Door Hardware



199

Secure locking closures stabilize gates, lids, doors, compartments, and hatches to prevent inward swinging.

Hand Rails & Handles



201

Streamlined, strong, and shaped to fit on runabouts, fishing boats, jet boats, and RVs.

Gas Springs & Mounting Brackets



202

Attwood offers a wide selection of gas springs, made with bio-degradable no hazard to water grade oil, making them the marine industry's most environmentally friendly gas springs.



Cleats



Neat Cleat

The Neat Cleat design offers what you've been asking for — a retractable cleat with a thin profile that installs easily on narrow gunwales.

- Beautiful, strong and durable – each stanchion is a 7/8" rod of solid Enhanced 316 Stainless Steel alloy
- Cleats stay up when pulled
- Backed by a lifetime warranty against corrosion

Installation is simple and quick – just drill twice with an appropriate size hole saw. Drainage chargers (included) capture moisture and send it to the bilge via pitot tubing (not included). Attwood recommends using only stainless steel fasteners for stainless steel hardware.

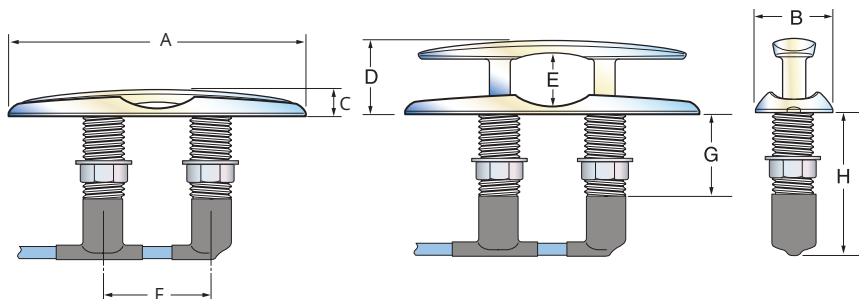
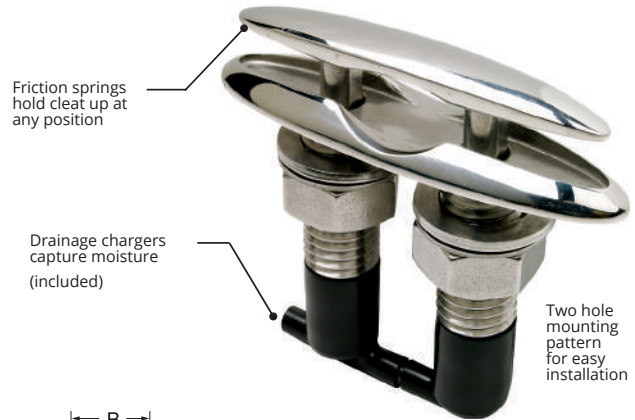

A	B	C	D	E	F	G	H	Installation			
Total Length	Total Width	Above Deck Lowered	Above Deck Raised	Line Opening	Between Stanchions	Thread Length	Install. Depth	Hole Saw Size	Max. Hull Thickness	OEM Part #	Part #
4-1/2"	1-5/16"	1/2"	1-5/8"	1-1/4"	1-3/4"	1-3/4"	3-1/8"	1"	1"	66515-1	66515-7
6"	1-1/2"	1/2"	1-5/8"	1-1/4"	2-1/4"	1-3/4"	3-1/8"	1"	1"	66517-1	66517-7
8"	1-15/16"	3/4"	2"	1-3/8"	2-13/16"	2-1/4"	3-3/4"	1"	1-1/2"	66519-1	—
10"	2-7/16"	13/16"	2-5/8"	1-5/8"	3-1/2"	2-7/8"	5-1/4"	1"	1-1/2"	66538-1	—

Neat Cleat Accessories

Description	OEM Part #	Part #
Backing Plates		
For 4-1/2" Neat Cleat	66529-1	—
For 6" Neat Cleat or Combo Cleat	66531-1	—
For 8" Neat Cleat or Combo Cleat	66533-1	—
Spacers		
For 6" Neat Cleat or Combo Cleat	66617-1	—

For our Stainless Steel Thru-Hulls and Scuppers see Pages 26-27.



Flush Cleats

This cleat recesses flush to the deck for a clean, contemporary look at an affordable price. Two mounting styles include an exclusive stud-mounted cleat (patented). Water-resistant cleat recesses into cast body, and is captured with lubricated seals. Durable, enhanced cast 316 Stainless Steel construction and simple design assures long-life and dependable operation.

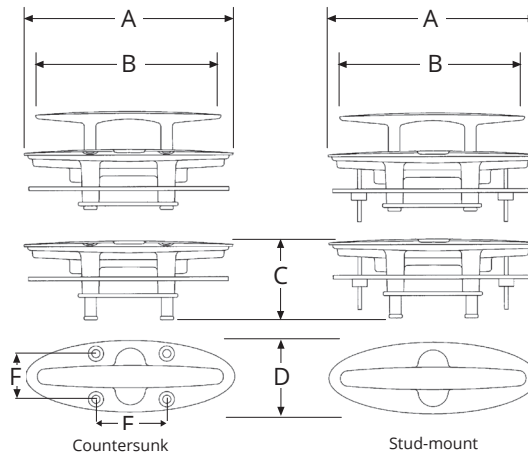

66510



66512

Easy Installation

- Includes backing plate
- Enhanced 316 Stainless Steel Alloy

Description	A	B	C	D	E	F	Fastener Quantity	OEM Part #	Part #
Countersunk*									
4-1/2" Cleat	5-1/4"	4-1/2"	3-1/8"	2"	1-5/8"	1-7/16"	(4) #10	66510-1	66510-7
6" Cleat	7"	6"	3-1/3"	2"	1-7/8"	1-21/32"	(4) 1/4"	66514-1	66514-7
8" Cleat	8-1/2"	7-3/4"	3-7/8"	2-13/16"	3-1/2"	2-1/8"	(4) 1/4"	66522-1	—
Stud-Mount*									
4-1/2" Cleat	5-1/4"	4-1/2"	3-1/8"	2"	—	—	—	66512-1	—
6" Cleat	7"	6"	3-1/3"	2-3/8"	—	—	—	66516-1	66516-7
8" Cleat	8-1/2"	7-3/4"	3-7/8"	2-13/16"	—	—	—	66524-1	—

* Countersunk models: Fasteners not included. Stud mount: Fasteners are included.



Folding Cleat

This Enhanced 316 Stainless Steel construction folding cleat locks down to the flush position when not in use, or easily flips up and locks in place when needed. Contemporary look for an economical price. Available with (flush-mount) and without (stud mount) visible holes for mounting.



66586



66588

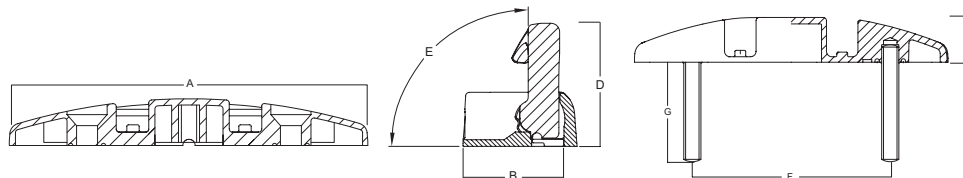

Description	A	B	C	D	E	F	G	Fasteners Included	OEM Part #	Part #
Flush Mount										
4-1/2" Cleat	4-3/5"	1-1/10"	3/5"	1-1/2"	90°	2-5/8"	—	No	66586-1	—
Stud Mount										
4-1/2" Cleat	4-3/5"	1-1/10"	3/5"	1-1/2"	90°	2-5/8"	1-11/16"	Yes	66588-1	—
6" Cleat	5-7/10"	1-3/5"	4/5"	1-17/20"	90°	3-3/5"	1-4/5"	Yes	66589-1	—

Whitley Cleats

The innovative Whitley Cleat is an Attwood exclusive! The unique, offset design is inspired by contemporary Euro styles. Yet, for all its good looks, this sturdy cleat exceeds ABYC strength standards!

- Polished stainless finish provides an attractive, premium appearance for the finest boats
- Alloy is certified Enhanced 316 Stainless Steel. Acid and rinsing baths remove surface contaminants and produce a mirror-finish hydrous oxide film. Backed by a Lifetime Warranty against corrosion
- Stud mounting leaves no exposed fasteners to collect water or dirt
- Stainless steel locking nuts and washers are supplied to fit the concealed stainless steel studs

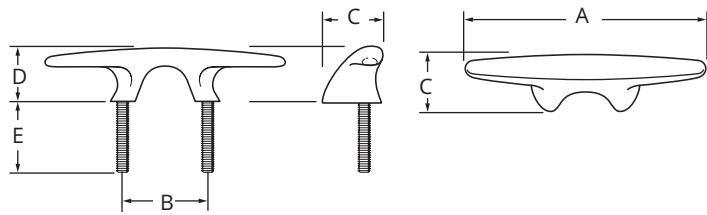

Cantilevered offset profile follows contour of contemporary hulls

Oversized stanchions for sturdy appearance and performance

Stud diameters range from 5/16" to 7/16"

Stainless steel locking nuts and washers included



LIFETIME WARRANTY

Description	A	B	C	D	E	Stud Size	OEM Part #	Part #
6-1/2" long	6-1/2"	2-13/16"	1-1/2"	1-1/2"	2"	5/16" x 18	66062-1	—
8-1/2" long	8-1/2"	2-15/16"	2"	1-7/8"	2-1/2"	3/8" x 16	66063-1	—
10-1/2" long	10-1/2"	3-3/16"	2-15/16"	2-3/16"	3"	7/16" x 14	66064-1	—

Contemporary Cleats

These beautiful cleats have a modern look and are priced to compete. The clean lines and well-defined surfaces are in tune with styling of today's boats. Thick stanchions offer hearty appearance and performance. Enhanced 316 Stainless Steel alloy. Guaranteed for life. Stainless locking nuts and washers included.

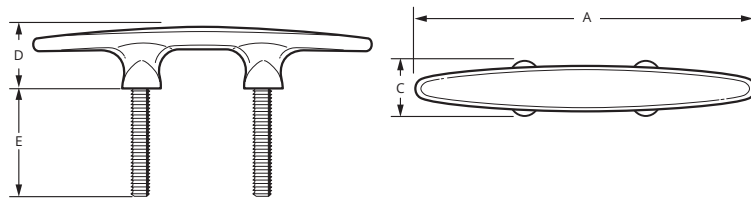

66054

LIFETIME WARRANTY

Description	A	B	C	D	E	Stud Size	OEM Part #	Part #
6" long	6"	2-1/4"	1"	1-3/16"	2"	5/16" x 18	66054-1	—
8" long	8"	2-13/16"	1-15/16"	1-3/8"	2-1/2"	7/16" x 14	66055-1	—
10" long	10"	3-5/8"	1-11/16"	1-13/16"	3"	7/16" x 14	66056-1	—

Stud Mount Herreshoff Cleat

This cleat features the classic look of a traditional Herreshoff design plus all the advantages of a stud mount installation. Enhanced 316 Stainless Steel alloy. Guaranteed for life. Stainless locking nuts and washers included.

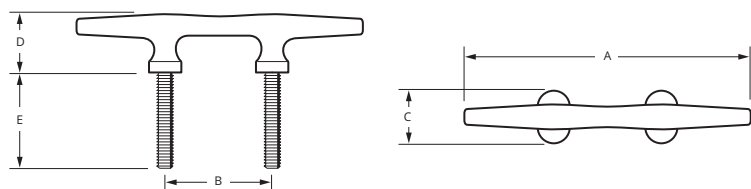

66336

LIFETIME WARRANTY

Description	A	B	C	D	E	Stud Size	OEM Part #	Part #
4" long	4"	1-3/16"	9/16"	1"	1-1/4"	1/4" x 20	66334-1	—
6" long	6"	2-1/4"	7/8"	1-1/4"	1-3/4"	1/4" x 20	66335-1	—
8" long	8"	2-7/8"	1-3/16"	1-1/2"	2"	5/16" x 18	66336-1	—

Herreshoff Cleats

Classic Herreshoff style cleat provides traditional styling, easy line tie-off, and corrosion resistance. Made of Enhanced 316 Stainless Steel alloy. Four holes for required fasteners.

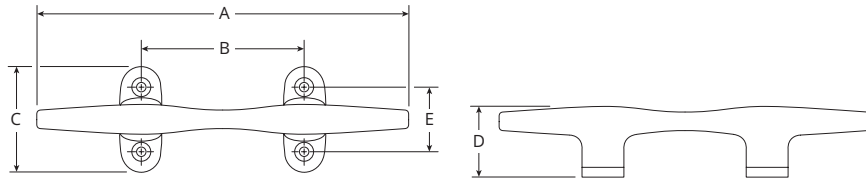

66398

Description	A	B	C	D	E	Fastener Quantity	OEM Part #	Part #
5" long	5"	2-9/64"	1-1/2"	1-1/8"	1"	(4) #10	66398-1	—
6" long	6"	2-1/4"	1-7/8"	1-1/4"	1-9/64"	(4) 1/4"	66009-1	66009L6
8" long	8"	2-27/32"	2-3/16"	1-1/2"	1-11/32"	(4) 1/4"	66010-1	66010L3
10" long	10"	3-3/4"	2-11/16"	1-7/8"	11-1/16"	(4) 5/16"	66011-1	66011-3
12" long	12"	3-7/8"	2-3/4"	2-3/16"	1-15/16"	(4) 5/16"	66012-1	—

Heavy-Duty Herreshoff Cleats

This heavy-duty Herreshoff is a wider, taller, and heavier version of the standard Herreshoff cleat. Made of Enhanced 316 Stainless Steel alloy. Four holes for required fasteners.

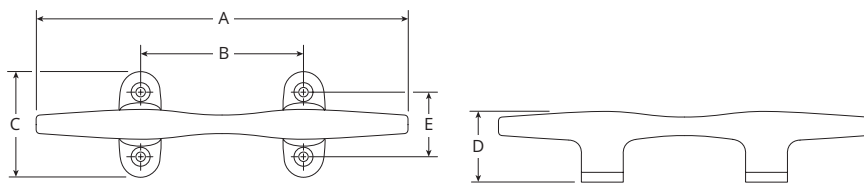

66110

Description	A	B	C	D	E	Fastener Quantity	OEM Part #	Part #
8" long	8"	2-9/64"	1-1/2"	1-1/8"	1"	(4) #10	66110-1	66110-3
10" long	10"	2-1/4"	1-7/8"	1-1/4"	1-9/64"	(4) 1/4"	66111-1	66111-3
12" long	12"	2-27/32"	2-3/16"	1-1/2"	1-11/32"	(4) 1/4"	66112-1	—

Fender Cleat

Stainless steel. Easily secure fenders to your boat with a simple lift of this retractable cleat. Durable, enhanced cast 316 Stainless Steel construction and simple design assures long life and dependable operation. Small 3-1/2" design.

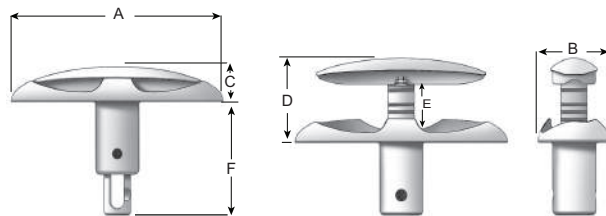

66502



A	B	C	D	E	F	Hole Distance	OEM Part #	Part #
Total Length	Total Width	Above Deck Lowered	Above Deck Raised	Max. Line Opening	Install. Depth	1-11/16"	66502-1	—
3-1/2"	1-3/16"	9/16"	1-3/8"	3/4"	1-7/8"			

(Not for use for mooring, towing or lifting.)

Chrome-Plated Zinc Cleats

These studded cleats have a modern look and are priced to compete. The clean lines and well-defined surfaces are in tune with styling of today's boats. Thick stanchions offer hearty appearance and performance.

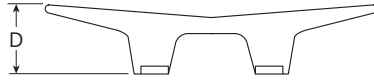
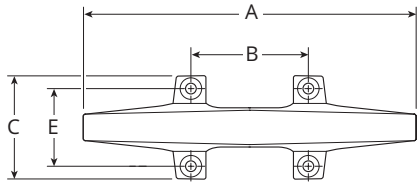

12022

Description	A	B	C	D	E	Fastener Quantity	OEM Part #	Part #
4-1/2" long	4-1/2"	1-11/16"	1-5/8"	1-1/16"	1-3/16"	(4) #8	6244-1	6244-6, pair
6" long	6"	2-7/32"	2-3/32"	1-11/32"	1-1/2"	(4) #10	6245-1	12009-3 6245-6, pair

Cast Aluminum Cleats

Cast aluminum cleats, available in 4 popular sizes. Ideal for small boats and docks. Two holes for required fasteners.

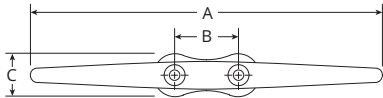

12120

Description	A	B	C	D	Fastener Quantity	OEM Part #	Part #
4-1/2" long, closed base	4-1/2"	2-7/32"	3/4"	1-1/2"	(2) 1/4"	12120-1	12121-3
6" long, closed base	6"	1-3/8"	7/8"	1-13/32"	(2) 1/4"	12124-1	12125-3
8" long, open base	8"	1-1/2"	1-1/16"	1-3/4"	(2) 1/4"	12126-1	12127-3

Cast Iron Cleats

Cast iron dock cleat with galvanized finish, available in 2 popular sizes. Two holes for required fasteners.

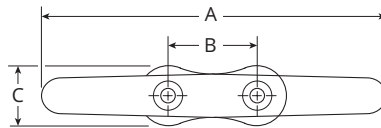
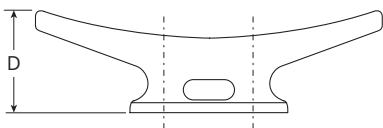

12100

Description	A	B	C	D	Fastener Quantity	OEM Part #	Part #
6" long	6"	1-3/8"	7/8"	1-3/16"	(2) 1/4"	—	12100L3
8" long	8"	1-7/8"	1-1/8"	1-5/8"	(2) 3/8"	12102-1	12102L3

Nylon Cleats

Corrosion-resistant light weight cleats. Two holes for required fasteners.

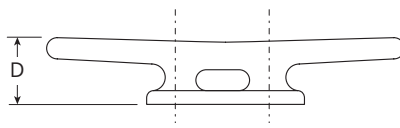
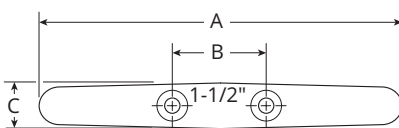

12110

Description	A	B	C	D	Fastener Quantity	OEM Part #	Part #
5" long	5-1/16"	1-29/64"	23/32"	1-1/64"	(2) #12	12110-1	12111L3
6-1/2" long	6-13/32"	1-21/32"	13/16"	1-7/32"	(2) #12	12112-1	12113L3
8" long	7-15/16"	1-51/64"	15/16"	1-3/8"	(2) 1/4"	12114-1	12115L3

Lift Rings



Stainless Steel Lift Ring

Attwood's stern-mounted lift ring provides heavy-duty strength for boats lifted by davits, cranes or shore stations. Lifts a maximum vertical load of 12,000 lbs. Installs with 1/2" countersunk stainless steel screws and washers, which must be through-bolted with locking washers or locking nuts.

Warning: Lift rings are designed to lift a boat only when fastened to the boat structure. The maximum lifting load figures listed were determined by applying a test load in the direction of the eye shank axis, with the shank fixed in an immovable testing device. Listed lifting loads are for reference only.

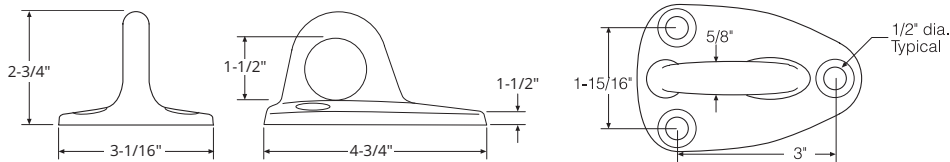

66120

Description	OEM Part #	Part #
Stainless steel lift ring	66120-1	—

Large Flush Lift Ring, Brass

Large lifting ring allows a full grip. Provides strength for lifting large and heavy hatch covers. Flush appearance, neatly recessed for safety. Chrome-plated brass. Pre-drilled with four holes for #6 fasteners.

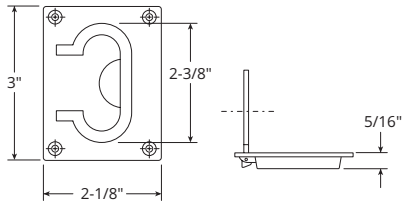

3325

Description	Flange Size	Handle Size	Fastener Quantity	OEM Part #	Part #
Brass	3" L x 2-1/4" W	2" L x 3/4" I.D. ring	(4) #6	—	3325-3

Hawse Pipes & Bow Eyes



Enhanced 316 Stainless Steel alloy Hawse Pipes reduce deck and rope chafing when attaching dock lines to cleats mounted inside the cockpit. Available in a variety of shapes and sizes for different installation locations.

Double-Sided Oval Hawse Pipe

Enhanced 316 Stainless Steel alloy Hawse Pipe. Two-piece construction provides a finished appearance for cock-pit and gunwale installation. For 1-1/2" minimum deck thickness.

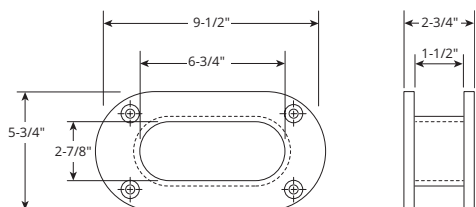

66224

Description	Fastener Quantity	OEM Part #	Part #
Opening Size: 6-3/4" L x 2-7/8" W	(4) #10	66224-1	—

Oval Hawse Pipes

Our most popular-sized Hawse Pipes. Available in two opening and flange sizes to fit your installation. Four holes for required #10 fasteners. Enhanced 316 Stainless Steel alloy.

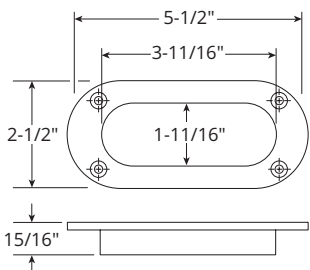

66223

Description	Fastener Quantity	OEM Part #	Part #
Opening Size: 3-11/16" L x 1-11/16" W	(4) #10	66223-1	66223-3

Rope/Deck Pipe

Use as an access lid to anchor chain and rope storage lockers. Cover is hinged and spring-loaded to stay shut without rattling. Cover can be locked in open position. Enhanced 316 Stainless Steel alloy.

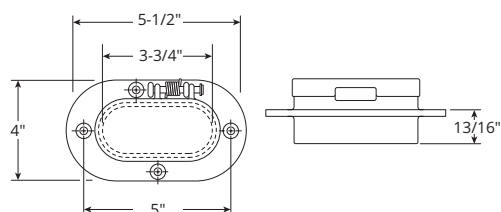

66008

Description	Installation Hole Size	Fastener Quantity	OEM Part #	Part #
Opening Size: 3-3/4" x 2-3/8"	4-1/8" long x 2-3/4" oval	(4) #10	66008-1	—

Bow Eyes, Stainless Steel

Bow eyes have twin shanks to prevent twisting. These rugged bow eyes, when transom-mounted can function as a ski tow.

Not to be used for lifting.

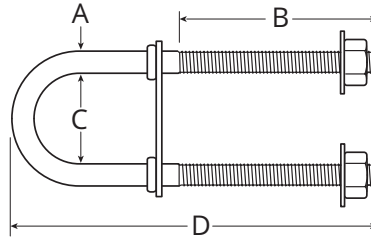

A	B	C	D	Face Plate Dimensions	Pull Strength (lbs.)	OEM Part #	Part #
With Plated Nuts and Washers							
5/16"-dia.	3/8"-16 x 2-7/16"	1-1/16"	4-3/8"	2-1/2" x 9/16"	6,000	3396-1	3396-3
7/16"-dia.	1/2"-13 x 3-1/4"	1-9/16"	5-5/8"	2-3/4" x 3/4"	12,000	3392-1	3392-3
With Stainless Steel Nuts and Washers							
5/16"-dia.	3/8"-16 x 2-7/16"	1-1/16"	4-3/8"	2-1/2" x 9/16"	6,000	66263-1	—
7/16"-dia.	1/2"-13 x 3-1/4"	1-9/16"	5-5/8"	2-3/4" x 3/4"	12,000	66261-1	66261L3
7/16"-dia.	1/2"-13 x 3-1/4"	1-9/16"	5-5/8"	3-1/2" x 1-3/4"	12,000	66262-1	—

Hooks

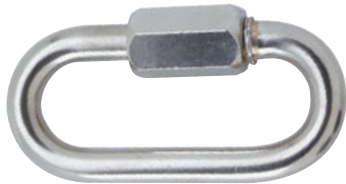

12891

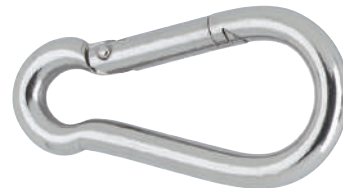

12415

Chain Link

For easy connection of anchor rope thimbles to anchor chain. Available in rugged stainless steel or zinc-plated steel construction material.

Description	Diameter	Length	Maximum Safe Load ∇	OEM Part #	Part #
Stainless Steel	5/16"	2-7/8"	3,000 lbs.	—	12891L3
Zinc-Plated Steel	7/32"	2-1/4"	1,000 lbs.	—	12355-3
	5/16"	3"	2,000 lbs.	—	12357-3

Marine Carabiner

Spring-loaded closure.

Description	Length	Ring Diameter	Maximum Safe Load ∇	OEM Part #	Part #
Stainless Steel	2-1/2"	1/4"	350 lbs.	12412-1	—
	3-1/8"	5/16"	575 lbs.	—	12415L3
Zinc-Plated Steel	2-1/2"	1/4"	300 lbs.	—	12303-3
	3-1/2"	3/8"	600 lbs.	—	12305-3
	3-1/8"	5/16"	700 lbs.	—	7651-3



7653

7640

Utility Snap Hook

Zinc-plated steel with spring-loaded closures.

Description	Length	Ring Diameter	Maximum Safe Load ∇	OEM Part #	Part #
Light-duty	4"	1/4"	500 lbs.	—	7653L3
Heavy-duty	4"	5/8"	2,500 lbs.	—	7640-3



9146

Clamp-On Oarlocks

Zinc-plated steel resists rust. Oarlock fastens securely to oar with one adjustable bolt, no drilling required.

Description	OEM Part #	Part #
Shank 1/2"-dia. x 2"	—	9146-3

∇ Maximum safe load is approximately half of maximum load or break strength. Do not exceed maximum safe load. Do not use in applications where life or limb is at risk.

Water Ski Hardware

Flush Mount Ski Tow

This Enhanced 316 Stainless Steel alloy Ski Tow mounts flush to the transom and has no exposed fasteners. Offers a clean look and prevents snags. The elliptical hook accepts up to 5/8" tow line, but rises only 1/2" outward and blends perfectly with the circular body. Easy to install by drilling one 2-1/8" diameter hole with a hole saw. The wide flange covers a bead of sealant and large aluminum backing plate provides solid holding. Backing plate and stainless locking nuts included. Exceeds American Water Ski Association standards for strength. Patented. Backed by a limited lifetime warranty against corrosion.

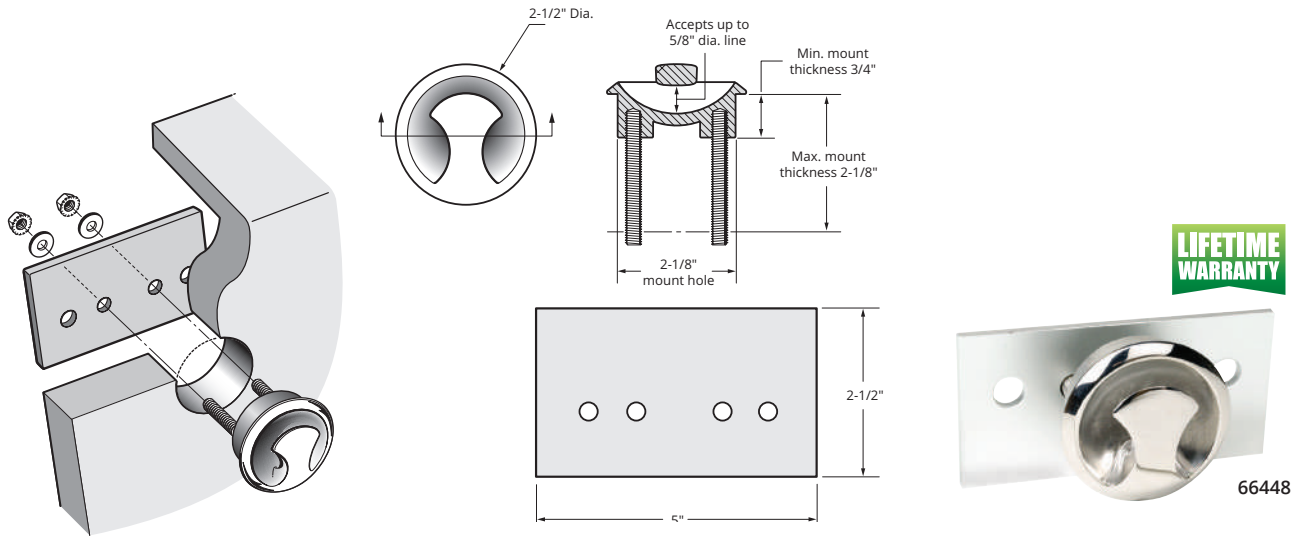

Description	OEM Part #	Part #
Stainless Ski Tow with 2-1/2" x 5" backing plate	66448-1	—

Ski Tows

Constructed of 304 Stainless Steel for corrosion-resistance, these tows are ideal for PWC's, I/O's, and inboard ski boats. All welded seams are smoothed and the surface has a highly polished finish. Stainless steel mounting washers and nuts included. A wide, welded-on mounting ring meets the hull so no exterior mounting plate is needed. Exceeds American Water Ski Association standards.

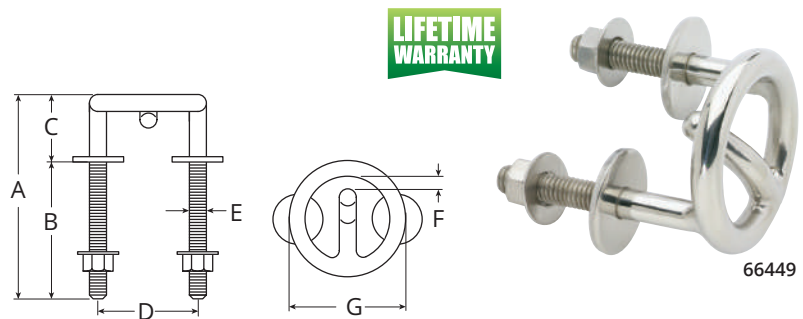

Ring Diameter	A	B	C	D	E	F	G	OEM Part #	Part #
2-1/2", short shank	2-7/8"	1-1/2"	1-5/16"	2-1/8"	3/8"	3/8"	2-1/2"	66449-1	—

Ski Pylons

The Attwood Difference

- Our heavy duty tow products will pull you anywhere you want to go
- We offer a wide range of configurations for swivel heads, posts, and bases
- Our towing products offer advanced features for durability and quality performance
- The Pro-Swivel has a 360° rotational head with a nylon bushing for smooth slalom pulling

DO NOT use Ski Pylons to pull any recreational equipment that is tied to the tow rope such as water tubes, aquaplanes, wakeboards, etc.



Description	Post Dia.	Post Height	Post Base	Arm Dia.	Arm Length	Arm Base	OEM Part #	Part #
Fixed Height								
Stainless Steel	1-1/4"	36"	2' x 4" Below Deck	1"	33"-56"	Perm. Thru Deck	9436-S	—
	1-1/4"	43"	2' x 4" Below Deck	1"	33"-56"	Perm. Thru Deck	9433-S	—
	2"	45"	6" Dia. SS	1"	33"-56"	Rem. Clev. Pin	923-009	—
	1-1/2"	23"	2' x 4" SS Base	1"	33"-56"	Rem. Clev. Pin	922-ADJ-S	—
		29"	3/4" Pin Base	1"	33"-56"	Rem. Clev. Pin	903-008-T-S	—
		45"	6" Dia. SS	1"	33"-56"	Rem. Clev. Pin	903-009-S	—
Adjustable Height								
Stainless Steel	2"	34"-58"	6" Dia. SS	1"	33"-56"	Rem. Clev. Pin	923-009-ADJ	SP-923-009-ADJ
	1"	28"-33"	Nylon Flush Mount	1"	33"-56"	Nylon Flush Mount	96008	SP-96008
		35"-52"	Nylon Flush Mount	1"	33"-56"	Nylon Flush Mount	—	SP-96009

Ski Pylon Replacement Parts

Description	OEM Part #	Part #
Threaded Base, Polished Stainless Steel, 6" Diameter	—	952
Deck Clevis, Set	—	SP-910



Stainless Steel Base
952



Deck Clevis Set
SP-910

Bimini Style Convertible Top Accessories

Deck Hinges

These deck hinges feature a flat base for deck mounting and have two holes for #10 fasteners. Enhanced 316 Stainless Steel alloy for corrosion-resistant support system of bimini tops. Stainless steel pin is springloaded for easy top removal.



66104

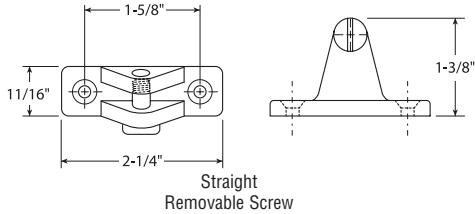

Description	Base Dimensions	Fastens to Bimini Bow Top Cap with:	OEM Part #	Part #
Straight base	2-1/4" x 11/16"	1/4"-20 removable screw	66104-1	—

Tethered 1/4" Spring-Loaded Clevis Pin

For use with Attwood deck or rail mounted bimini top hinge fittings that use removable 1/4" spring-loaded clevis pins. This handy 1/4" spring-loaded clevis pin with lanyard allows the pin to be tethered to prevent loss of the pin when removed from the bimini top deck or rail hinge fitting.

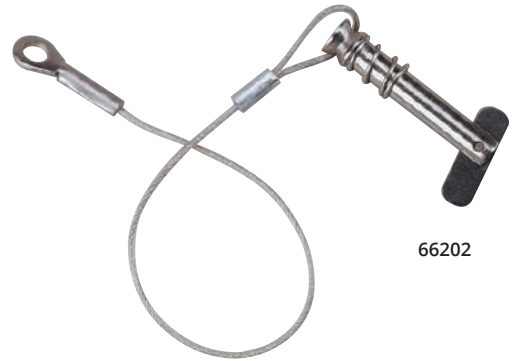

66202

Description	Use With Attwood Deck or Rail Hinge	OEM Part #	Part #
Removeable tethered 1/4" Spring-loaded clevis pin	66160, 66200 66220, 66383	—	66202-3

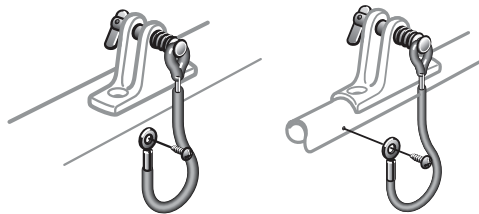

Eye Straps

All eye straps are pre-drilled with two mounting holes.

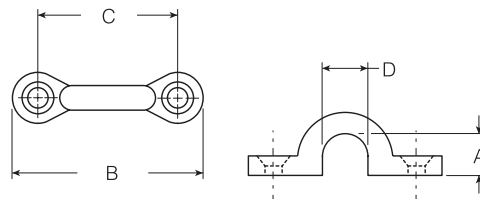

Description	A	B	C	D	Fastener Quantity	OEM Part #	Part #
Cast Stainless Steel	3/8"-diameter	1-7/8" long	1-3/8"	1/2"	#10 fasteners (2)	66105-1	—
Chromed bronze	5/16"-diameter,	1-7/8" long	1-3/8"	1/2"	#10 fasteners (2)	12988-1	—

Hinges

Cast Stainless Steel Hinges

These hinges are cast from enhanced 316 stainless steel. They combine a great eurostyle look with a polished finish. Available in stud or countersunk mounting styles, these hinges look attractive on any vessel! Hinges are mirror polished to the highest specification in the industry and passivated to enhance surface finish and corrosion-resistance. The hinge pin design allows lid to open a full 180°.



Round Hinge, Cast Stainless Steel

Smooth, full round plate design.

Description	Fastener Quantity	OEM Part #	Part #
Counter-sunk	#12 fasteners (4)	66240-1	—

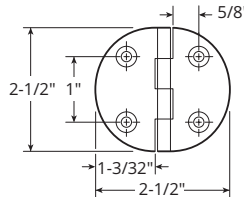

Flush Hinges

The unique double stud design of these hinges allows for a flush installation while still providing a full 180° swing. This makes them the perfect hinge for lazzerette or fish box covers in the cockpit sole.

Flush Hinge, Square End, Stamped Stainless Steel

Square end 2-pin hinge with radiused corners. Six holes for required fasteners. Made of solid stamped stainless steel to provide years of maintenance free service.

Description	Fastener Quantity	OEM Part #	Part #
Counter-sunk	#8 fasteners (6)	66239-1	66239-3

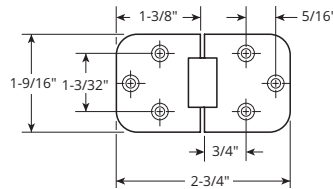

Strap Hinges, Cast Stainless Steel

Durable stainless steel strap hinges, available in standard or reverse strap styles.

Description	Strap Type	Dimensions	Fastener Quantity	OEM Part #	Part #
Four holes	Standard	4" W x 1" L	#10 screws	66025-1	—
	Reversed	4-1/8" W x 1-1/16" W	#10 screws	66434-1	—

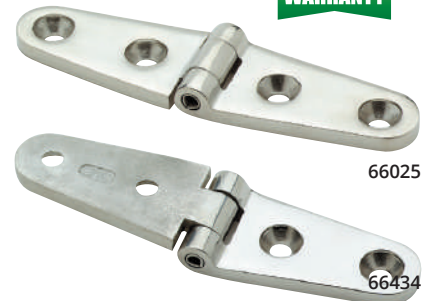
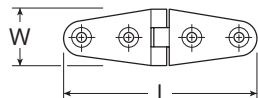

Butt Hinge, Stainless Steel

Strap hinge design with rounded ends.

Description	Fastener Quantity	Dimensions	OEM Part #	Part #
Cast Stainless Steel	#10 fasteners (4)	1-1/2" x 1-1/2"	66163-1	—



66163

Door Hinges, Stainless Steel

Durable cast stainless steel door hinges, available in a variety of lengths. Pair included.

Description	Dimensions	Fastener Quantity ∞	OEM Part #	Part #
Six holes	3" L x 1-1/2" W	#10 fasteners	66028-1	—
	4" L x 1-1/2" W	#10 fasteners	66029-1	66029-3

∞Pin on top

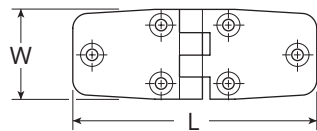

66028



66029

Take-Apart Motor Box Hinge, Non-Locking

For use on motor box or hatch cover. Take apart feature allows removal of cover for engine service or bilge access.

Description	Open Size	Fastener Quantity	OEM Part #	Part #
Brass	4" x 2"	#10 fasteners (4)	1329-1	—

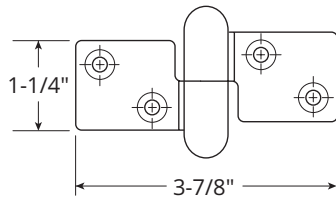

1329

Hatch Hinges

For use on flush hatch covers to prevent cover from folding all the way backward. Cover remains upright when open. Hatch hinges feature a quick-release pin with safety ring so hatch can be completely removed without unscrewing the base.

Hatch Hinge, Stainless Steel

Description	Open Size	Fastener Quantity	OEM Part #	Part #
Cast Stainless Steel	3-1/2" x 1-3/8"	#10 fasteners (4)	66027-1	66027-3

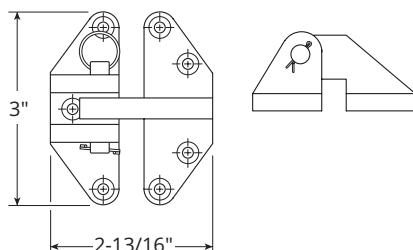

66027

Hatch & Door Hardware

Padlock Eye Clamps

For use on tackle, bait, and ice boxes that require draw-down pressure-tight seal. Also for hatch or motor box clamps. Accommodates padlocks with 1/4"-diameter or smaller shackle. Flush mount model 2012 has no exposed mounting screws. Chrome finish. Rugged, secure locking device with easy-to-use flip handle.



2012A

Description	Closed Size	Fastener Quantity	OEM Part #	Part #
Flush mount	4-1/4" x 1-1/2"	#8 fasteners (4)	2012A1	2012A3

Slam Latches

Round slam latches fits up to 7/8" door thickness. Made of UV stable and corrosion resistant materials. Include stainless steel mounting hardware.



Description	OEM Part #	Part #
Stainless Steel	66832-1	—

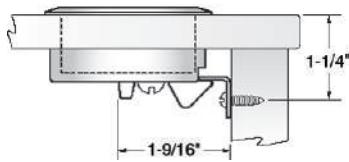

66832

Pontoon Replacement Latch

This durable lock set is a complete replacement kit for your pontoon's gate latch. Universal sizing fits square frames of 1", 1-1/8", and 1-1/4" on both left and right hinged gates. Secure closure stabilizes gate and prevents inward swinging. Includes mounting hardware for quick and easy installation.



11404

Description	OEM Part #	Part #
Universal Replacement Gate Latch	8-1/2" x 9-1/2" x 5-1/2"	— 11404-6

Swivel Hasps, Stainless Steel

For storage compartments that need to be securely locked. Ideal for lockers, cupboards, chests, and hatch doors.

Accommodates padlocks with 1/4" dia. or smaller shackle. Swivel eye turns to secure the hasp and keep the compartment shut, even without use of a padlock. Stamped stainless steel construction with chrome finish.



66423

Description	Closed Size	Fastener Quantity	OEM Part #	Part #
Flush mount	3" x 1-1/8"	#8 fasteners (4)	66423-1	—

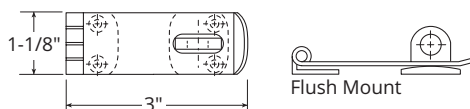

Flush Hatch Pulls

The new low profile flush hatch pull is an easy access handle for installation in lids, doors, compartments, and hatches. Handle is easy to grip, even with gloved hands. Made of glass filled propylene with black textured finish.

Description	Fastener Quantity	OEM Part #	Part #
Rectangular	#6 fasteners (4)	2027-1	2027-7
Round	#6 fasteners (4)	2028-1	—

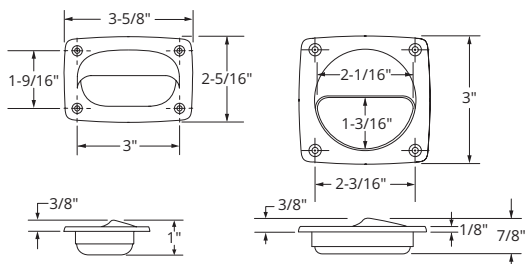

2027



2028

Deck Plate/Inspection Port

For inspection and general access to valves and deck vents. Easy opening, screw-out design—no tools required. High impact ABS plastic with textured surface. Durable, rugged, weather-resistant. Flange is pre-drilled with six holes.

Description	Color	Fastener Quantity	OEM Part #	Part #
4"-dia.	White	#8 fasteners (6)	12790-1	12790-3
	Black	#8 fasteners (6)	12791-1	—
6"-dia.	White	#8 fasteners (6)	12792-1	—
8"-dia.	White	#8 fasteners (6)	12794-1	—



12791



12794

Hatch Lift Spring, Stainless Steel

Deflecting spring holds hatch or motor box open, bends to close. Stainless steel, flush mounting.

Description	Fastener Quantity	OEM Part #	Part #
7/16"-dia. x 8-3/4"	#8 fasteners (2)	12460-1	12461-3



12460

Handles & Hand Rails

Vinyl Grab Handles

Streamlined with a molded, hinged, built-in fastener cover system, an Attwood exclusive. A unique, grab handle that looks and works great on runabouts, fishing boats, jet boats, and RV's. Clean styling, shaped to fit your hand for a secure grip. This one-piece design eliminates the problem of loose caps which pop off over time and become lost. The covers are hinged on the base of the handle and are pushed closed after securing the mounting fasteners. Strong, polypropylene inner core with a molded vinyl cover withstands harsh marine environments. Install via thru-bolting or wood screws.

Color	Fastener Quantity	OEM Part #	Part #
White	#12 fasteners (2)	2050-1	2050-5
Gray	#12 fasteners (2)	2053-1	2053-5
Black	#12 fasteners (2)	2054-1	2054-5

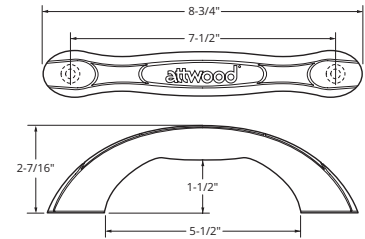
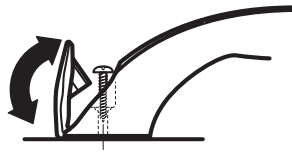

Flexible Grab Handles

Flexible grab handles for flush, flexible mounting. They can be mounted to a variety of irregular surfaces and angles on swim platforms, cockpits and companionways. Constructed from soft polypropylene webbing over a semi-rigid core. Available with or without an over-molded grip. Because of the soft, pliable webbing in these handles and the absence of any sharp edges, they are safe in areas where occupants might impact them. They meet the ABYC H-41 standard for strength: "withstand a load of 400 lbs. in any direction." All materials are non-corrosive, UV stable and mildew-resistant.

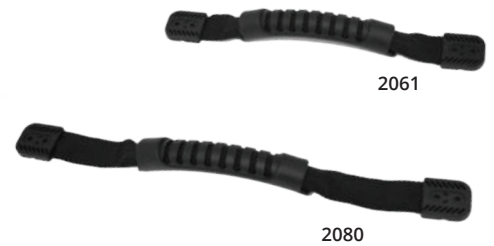
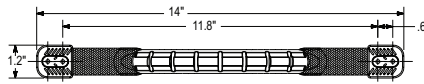
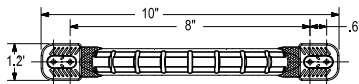

Description	Fastener Quantity	OEM Part #	Part #
Flexible grab handle w/over-molded grip	#12 fasteners (4)	2061-1	2061-5
Flexible grab handle w/over-molded grip, extended	#12 fasteners (4)	2080-1	—

Handrails, Stainless Steel

Exceed all ABYC H-41 requirements for Hand Rails. Standard and Flared configurations available.

Description	Length	OEM Part #	Part #
Flared	12"	66HRD12-1	—
Standard	9"	66HR09-1	—

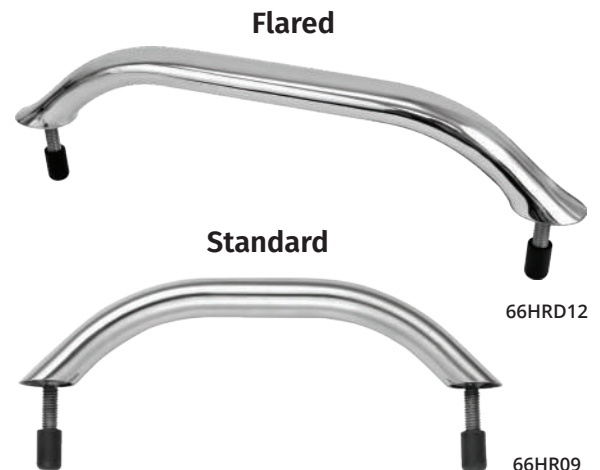

Gas Springs & Accessories

Attwood is partnered with Stabilus®, the world's leading supplier of gas springs and related products with over 100,000,000 units in the field. All Attwood springs are made with bio-degradable no hazard to water grade oil (WGK), making them the marine industry's most environmentally friendly gas springs. All springs pass ASTM B117, Attwood salt spray and a 30,000 cycle lifecycle test. Attwood springs come with support to ensure the proper spring for your specific application, including: marine, industrial, agricultural, pharmaceutical, food processing, and medical. Available in 6mm, 8mm and 10mm configurations between 10–200 lbs.

Ni-Slide Series

Attwood's widest selection of configurations and lengths. The industry's proven leader in value, quality and durability.

Stainless Steel Series

Attwood INOX Stainless Steel Series. Stainless steel shell and rod ensure corrosion-resistance and up to 30% lower cost than traditional stainless springs. All stainless steel series springs come with high-strength, corrosion-proof composite end fittings.

OEM Gas Springs

Length (inches)				Ni-Slide Series		Stainless Standard Series	
Extended	Compressed	Stroke	End Fitting Type	Available Output Force	OEM Part #	Available Output Force	OEM Part #
6 x 15 - 6MM ROD x 15MM CYLINDER							
6.50	4.90	1.60	6.3mm Dia. Blade	10-60	SL4-XX-1◇	—	—
7.50	5.25	2.25	10mm Socket	10-60	SL11-XX-1◇	10-70	ST11-XX-1◇
10.00	7.00	3.00	10mm Socket	10-60	SL10-XX-1◇	10-70	ST10-XX-1◇
12.04	8.46	3.58	10mm Socket	10-60	SL15-XX-1◇	10-70	ST15-XX-1◇
15.00	9.50	5.50	10mm Socket	10-60	SL13-XX-1◇	10-70	ST13-XX-1◇
17.20	10.20	7.00	10mm Socket	10-60	SL16-XX-1◇	—	—
20.00	12.00	8.00	10mm Socket	10-60	SL14-XX-1◇	10-70	ST14-XX-1◇
8 x 18 - 8MM ROD x 18MM CYLINDER							
7.50	5.25	2.25	10mm Socket	20-120	SL31-XX-1◇	20-120	ST31-XX-1◇
10.00	7.00	3.00	10mm Dia. Blade	20-120	SL1-XX-1◇	—	—
10.00	7.00	3.00	10mm Socket	20-120	SL30-XX-1◇	20-120	ST30-XX-1◇
10.50	7.50	3.00	10mm Socket	20-120	SL32-XX-1◇	20-120	ST32-XX-1◇
12.04	8.46	3.58	10mm Socket	20-120	SL35-XX-1◇	20-130	ST35-XX-1◇
15.00	9.50	5.50	10mm Dia. Blade	20-120	SL2-XX-1◇	—	—
15.00	9.50	5.50	10mm Socket	20-120	SL33-XX-1◇	20-150	ST33-XX-1◇
17.20	10.20	7.00	10mm Socket	20-120	SL36-XX-1◇	20-150	ST36-XX-1◇
20.00	12.00	8.00	10mm Dia. Blade	20-120	SL3-XX-1◇	—	—
20.00	12.00	8.00	10mm Socket	20-120	SL34-XX-1◇	20-150	ST34-XX-1◇
23.00	13.12	9.87	10mm Socket	30-120	SL38-XX-1◇	—	—
26.30	16.10	10.20	10mm Socket	20-120	SL37-XX-1◇	20-150	ST37-XX-1◇
10 x 22 - 10MM ROD x 22MM CYLINDER							
20.20	12.30	7.90	13mm Socket	30-240	SL20-XX-1◇	30-200	STX20-XX-1◇
20.20	12.30	7.90	10mm Socket	—	—	30-200	ST20-XX-1◇
26.30	16.10	10.20	10mm Socket	30-180	SL25-XX-1◇	—	—
26.97	15.20	11.77	10mm Socket	30-180	SL26-XX-1◇	30-200	ST26-XX-1◇
28.00	16.50	11.50	10mm Socket	30-180	SL27-XX-1◇	—	—
30.91	17.13	13.78	10mm Socket	30-180	SL28-XX-1◇	—	—
36.30	21.10	15.20	13mm Socket	30-180	SL29-XX-1◇	30-200	STX29-XX-1◇
36.30	21.10	15.20	10mm Socket	—	—	30-200	ST29-XX-1◇



Composite / Metal End Fitting (Ni-Slide)



NEW All Composite End Fitting (Stainless Steel)



Ball Socket Stainless Steel 13mm Ball Socket



Blade End

◇ To complete the part number, replace XX with the desired available output force 10-200 (lbs.)

(Example: SL14-10-1 = 10 lbs. output force, ST26-180-1 = 180 lbs. output force)

Aftermarket Gas Springs

Popular replacement gas springs and mounting brackets for the aftermarket. Attwood has taken the guess-work out of deciding which gas springs and mounting brackets to offer your marine and RV customers. Packaged in see-through hanging packages, gas springs and mounting brackets can be plan-o-grammed together to provide an attractive one-stop display for convenient customer selection. Additional packaged gas spring sizes and output forces are available. Ask your Attwood sales rep or customer service associate for details.

Length (inches)				Standard Output Force (lbs)	Ni-Slide Series Part #	Stainless Standard Series Part #
Extended	Compressed	Stroke	End Fitting Type			
6 X 15 - 6mm Rod X 15mm Cylinder						
10	7	3	10mm Socket	40	SL10-40-5	ST10-40-5
15	9.5	5.5	10mm Socket	20	SL13-20-5	—
15	9.5	5.5	10mm Socket	60	SL13-60-5	ST13-60-5
17.2	10.2	7	10mm Socket	30	SL16-30-5	—
20	12	8	10mm Socket	20	SL14-20-5	ST14-20-5
20	12	8	10mm Socket	30	SL14-30-5	ST14-30-5
20	12	8	10mm Socket	40	SL14-40-5	ST14-40-5
20	12	8	10mm Socket	50	—	ST14-50-5
20	12	8	10mm Socket	60	SL14-60-5	ST14-60-5
8 X 18 - 8mm Rod X 18mm Cylinder						
7.5	5.25	2.25	10mm Socket	20	SL31-20-5	ST31-20-5
7.5	5.25	2.25	10mm Socket	30	SL31-30-5	ST31-30-5
7.5	5.25	2.25	10mm Socket	40	SL31-40-5	ST31-40-5
10	7	3	10mm Diameter Blade	20	SL1-20-5	—
10	7	3	10mm Diameter Blade	40	SL1-40-5	—
10	7	3	10mm Socket	20	SL30-20-5	ST30-20-5
10	7	3	10mm Socket	40	SL30-40-5	ST30-40-5
10	7	3	10mm Socket	60	SL30-60-5	ST30-60-5
10.5	7.5	3	10mm Socket	20	SL32-20-5	ST32-20-5
10.5	7.5	3	10mm Socket	30	SL32-30-5	ST32-30-5
12.04	8.46	3.58	10mm Socket	20	SL35-20-5	ST35-20-5
12.04	8.46	3.58	10mm Socket	30	SL35-30-5	ST35-30-5
12.04	8.46	3.58	10mm Socket	40	SL35-40-5	ST35-40-5
12.04	8.46	3.58	10mm Socket	50	SL35-50-5	ST35-50-5
15	9.5	5.5	10mm Diameter Blade	40	SL2-40-5	—
15	9.5	5.5	10mm Socket	20	SL33-20-5	ST33-20-5
15	9.5	5.5	10mm Socket	30	SL33-30-5	ST33-30-5
15	9.5	5.5	10mm Socket	40	SL33-40-5	ST33-40-5
15	9.5	5.5	10mm Socket	50	SL33-50-5	ST33-50-5
15	9.5	5.5	10mm Socket	60	SL33-60-5	ST33-60-5
17.2	10.2	7	10mm Socket	20	SL36-20-5	ST36-20-5
17.2	10.2	7	10mm Socket	30	SL36-30-5	ST36-30-5
17.2	10.2	7	10mm Socket	40	SL36-40-5	ST36-40-5
17.2	10.2	7	10mm Socket	50	SL36-50-5	ST36-50-5
17.2	10.2	7	10mm Socket	60	SL36-60-5	ST36-60-5
17.2	10.2	7	10mm Socket	70	SL36-70-5	ST36-70-5
17.2	10.2	7	10mm Socket	80	SL36-80-5	—
17.2	10.2	7	10mm Socket	90	SL36-90-5	ST36-90-5
20	12	8	10mm Diameter Blade	60	SL3-60-5	—
20	12	8	10mm Socket	20	SL34-20-5	ST34-20-5
20	12	8	10mm Socket	30	SL34-30-5	ST34-30-5
20	12	8	10mm Socket	40	SL34-40-5	ST34-40-5
20	12	8	10mm Socket	50	SL34-50-5	ST34-50-5
20	12	8	10mm Socket	60	SL34-60-5	ST34-60-5
20	12	8	10mm Socket	80	SL34-80-5	ST34-80-5
20	12	8	10mm Socket	90	SL34-90-5	ST34-90-5
20	12	8	10mm Socket	120	SL34-120-5	ST34-120-5

Threaded Studs

Used as an alternative to mounting brackets, threaded studs can be mounted directly to hatches or other mounting surfaces in applications where the mounting surface is made of metal or another material with the strength to withstand the forces of a gas spring attachment point

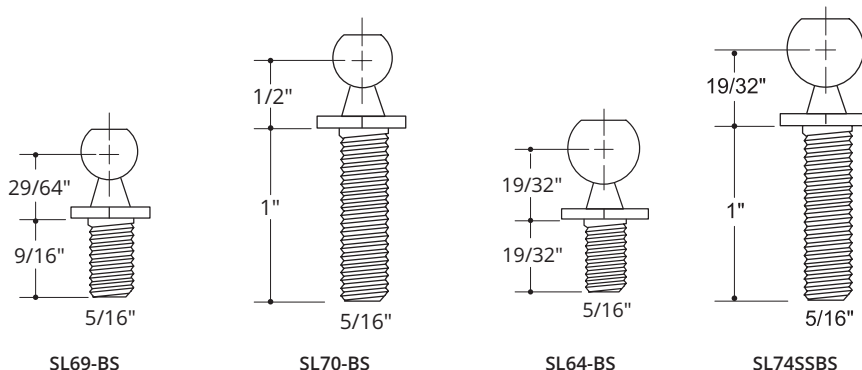

Choice of Attachment Points and Finish

Threaded studs are available with "Ball" or "Blade" gas spring attachment points, and a choice of materials, including zinc plated steel, or stainless steel.

Finish	Length	OEM Part #	Part #
With 10mm Ball End			
Zinc Plated	9/16"	SL69-BS-1	—
	1"	SL70-BS-1	—
Stainless Steel	3/4"	SL75-SSBS-1	—
	9/16"	SL69SSBS-1	—
With 13mm Ball End			
Zinc Plated	19/32"	SL64-BS-1	—
Stainless Steel	19/32"	SL64SSBS-1	—
	1"	SL74SSBS-1	—



Mounting Brackets

Mounting Brackets are used as attachment points for gas springs on hatches and other mounting surfaces where:

- Mounting surface material is not strong enough to support direct attachment of gas spring using a threaded stud
- The angle and position of the attachment point requires the need for a mounting bracket

Mounting brackets are available with Ball Pem gas spring attachment points, and a choice of materials and finishes, including zinc-plated steel (with or without black painted finish), stainless steel, or aluminum.

Aftermarket Mounting Brackets

Bracket Series No.	Style	Pem Type	Mounting Holes	Pem Direction	Finish	Part #
SL40	Flat	Ball 10mm	2	Forward	Stainless Steel	SL40SSP3-7
SL50	90°	Ball 10mm	2	Forward	Stainless Steel	SL50SSP3-7

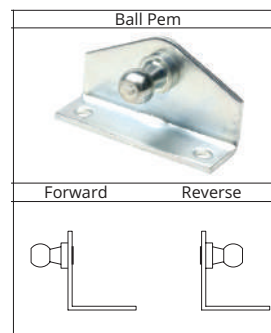

OEM Mounting Brackets

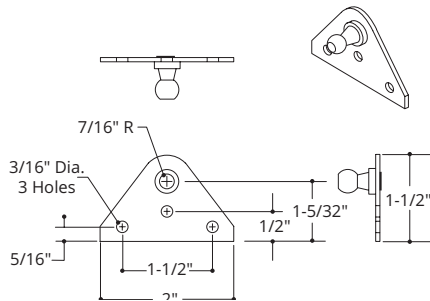

SL3H Bracket

Finish	Pem Direction	Pem Type	OEM Part #
Stainless Steel	Forward	Ball 10mm	SL3HSSP3-1

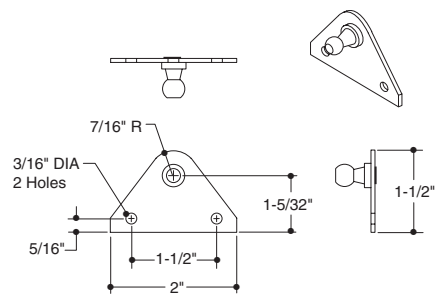

SL40 Bracket

Finish	Pem Direction	Pem Type	OEM Part #
Zinc-Plated	Forward	Ball 10mm	SL40P3-1
Black Painted	Forward	Ball 10mm	SL40BP3-1
Stainless Steel	Forward	Ball 10mm	SL40SSP3-1
Stainless Steel, Black Painted	Forward	Ball 10mm	SL40SSBP3-1

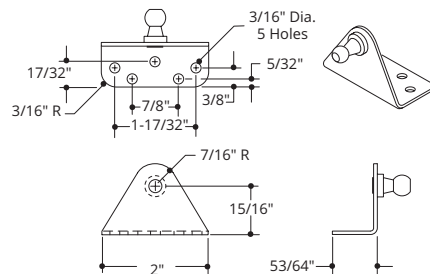

SL46 Bracket

Finish	Pem Direction	Pem Type	OEM Part #
Stainless Steel	Forward	Ball 10mm	SL46SSP3-1
	Reverse	Ball 10mm	SL46SSP3R-1

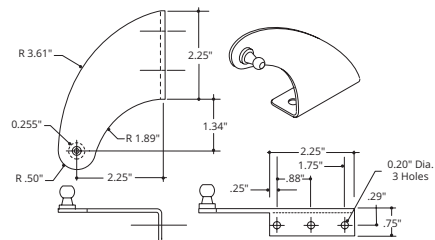

SL44 Left-Hand Crescent Bracket

Finish	Pem Direction	Pem Type	OEM Part #
Zinc-Plated	Forward	Ball 10mm	SL44P3-1
	Reverse	Ball 10mm	SL44P3R-1
Black Painted	Reverse	Ball 10mm	SL44BP3R-1
Stainless Steel	Forward	Ball 10mm	SL44SSP3-1

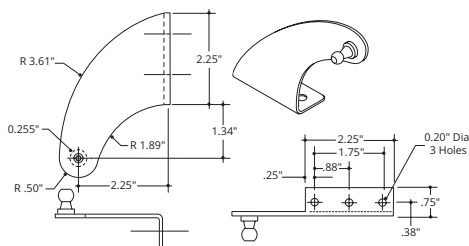

SL48 Right-Hand Crescent Bracket

Finish	Pem Direction	Pem Type	OEM Part #
Zinc-Plated	Forward	Ball 10mm	SL48P3-1
	Reverse	Ball 10mm	SL48P3R-1
Black Painted	Reverse	Ball 10mm	SL48BP3R-1
Stainless Steel	Forward	Ball 10mm	SL48SSP3-1

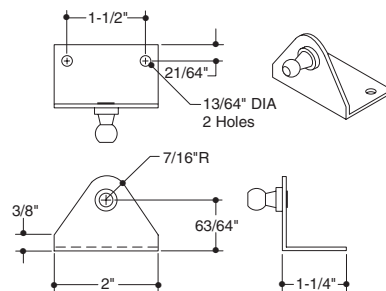

SL50 Bracket

Finish	Pem Direction	Pem Type	OEM Part #
Zinc-Plated	Forward	Ball 10mm	SL50P3-1
	Reverse	Ball 10mm	SL50P3R-1
Black Painted	Forward	Ball 10mm	SL50BP3-1
Stainless Steel	Forward	Ball 10mm	SL50SSP3-1
	Reverse	Ball 10mm	SL50SSP3R-1
Stainless Steel (3 holes)	Forward	Ball 10mm	SL50SSP3SB-1

Note: Bracket dimensions are the same with all "Pem" options. Dimensional drawings are shown with "Ball Pem" option.

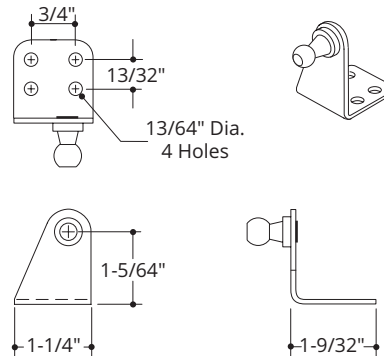
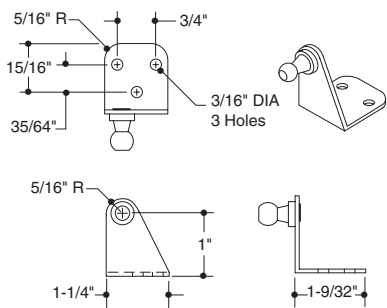

SL513H Bracket

Finish	Pem Direction	Pem Type	OEM Part #
Zinc-Plated	Reverse	Ball 10mm	SL513HP3R-1
Black Painted	Reverse	Ball 10mm	SL513HBP3R-1

SL514H Bracket

Finish	Pem Direction	Pem Type	OEM Part #
Stainless Steel	Forward	Ball 10mm	SL514HSSP3-1

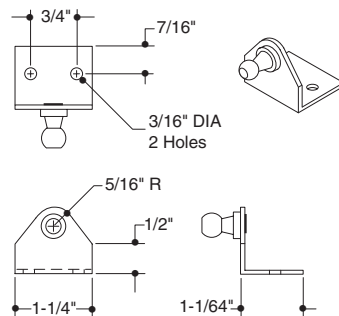
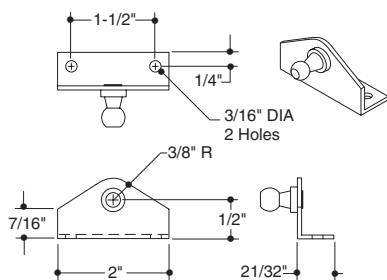

SL52 Bracket

Finish	Pem Direction	Pem Type	OEM Part #
Zinc-Plated	Forward	Ball 10mm	SL52P3-1
	Reverse	Ball 10mm	SL52P3R-1
Stainless Steel	Forward	Ball 10mm	SL52SSP3-1
	Reverse	Ball 10mm	SL52SSP3R-1

SL54 Bracket

Finish	Pem Direction	Pem Type	OEM Part #
Stainless Steel	Forward	Ball 10mm	SL54SSP3-1

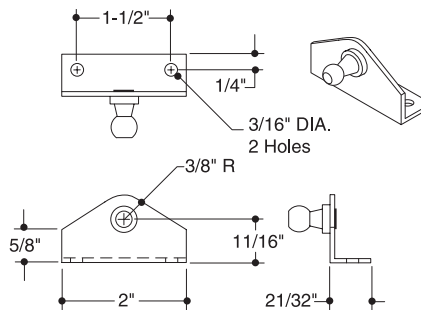
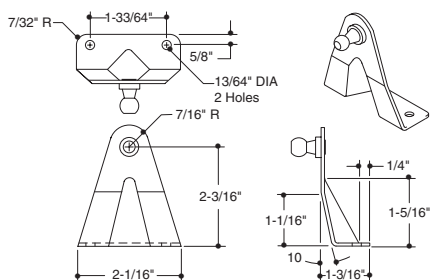

SL57 Bracket

Finish	Pem Direction	Pem Type	OEM Part #
Zinc-Plated	Forward	Ball 10mm	SL57P3-1
Stainless Steel	Reverse	Ball 10mm	SL57SSP3R-1

SL58 Bracket

Finish	Pem Direction	Pem Type	OEM Part #
Zinc-Plated	Forward	Ball 10mm	SL58P3-1
	Reverse	Ball 10mm	SL58P3R-1
Black Painted	Forward	Ball 10mm	SL58BP3-1
	Reverse	Ball 10mm	SL58BP3R-1
Stainless Steel	Forward	Ball 10mm	SL58SSP3-1
	Reverse	Ball 10mm	SL58SSP3R-1
Stainless Steel, Black Painted	Reverse	Ball 10mm	SL58SSBP3R-1

Note: Bracket dimensions are the same with all "Pem" options. Dimensional drawings are shown with "Ball Pem" option.

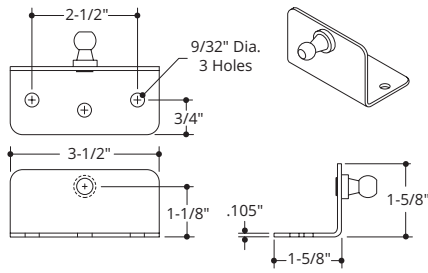

SL61 & SL63 Bracket

Finish	Pem Direction	Pem Type	OEM Part #
Stainless Steel	Forward	Ball 13mm	SL63SSBS-1
	Reverse	Ball 13mm	SL61SSBS-1

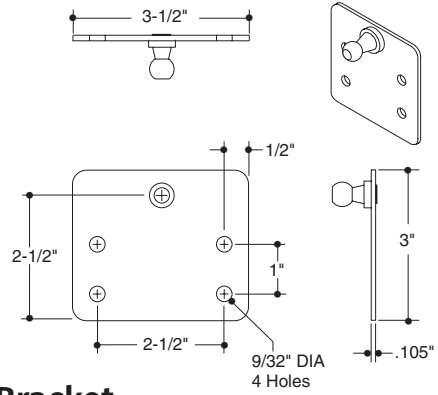

SL62 Bracket

Finish	Pem Direction	Pem Type	OEM Part #
Stainless Steel	Forward	Ball 13mm	SL62SSBS-1

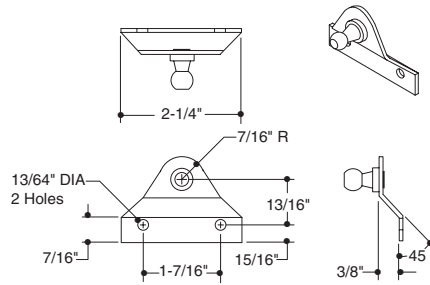

SL65 Bracket

Finish	Pem Direction	Pem Type	OEM Part #
Zinc-Plated	Forward	Ball 10mm	SL65P3-1
Black Painted	Forward	Ball 10mm	SL65BP3-1
Stainless Steel	Forward	Ball 10mm	SL65SSP3-1

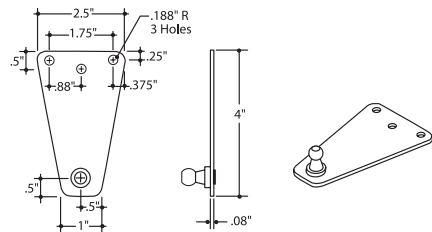

SL72 Bracket

Finish	Pem Direction	Pem Type	OEM Part #
Stainless Steel	Forward	Ball 10mm	SL72SSBS-1

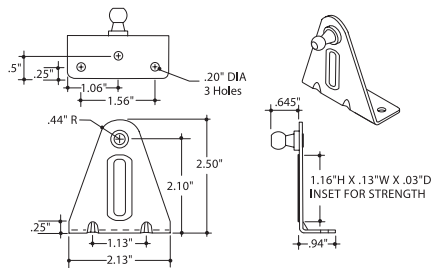

SL76 Bracket

Finish	Pem Direction	Pem Type	OEM Part #
Stainless Steel	Forward	Ball 10mm	SL76SSP3-1
	Reverse	Ball 10mm	SL76SSP3R-1

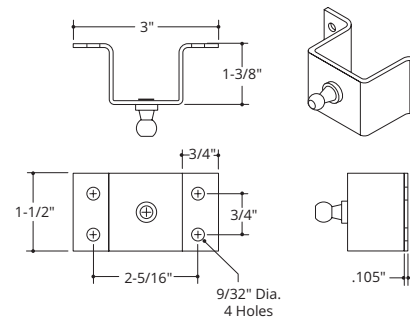

SL77 Bracket

Finish	Pem Direction	Pem Type	OEM Part #
Zinc-Plated	Forward	Ball 10mm	SL77P3-1

Note: Bracket dimensions are the same with all "Pem" options. Dimensional drawings are shown with "Ball Pem" option.

SEATING SYSTEMS & PEDESTALS



SEATING SYSTEMS & PEDESTALS

Fishing Seats



213

Attwood fishing seats are compact and provide enhanced strength and durability for long-term use.

Seating Systems



214

Find a match for every boater's style of comfort. Attwood seating and pedestal systems ensure safety, support, and comfort.

Pedestal Systems & Accessories



219

Unmatched strength, supreme stability, and ergonomic design. Attwood pedestal systems are engineered to last and meet industry standards.



Seat Types & ABYC Requirements

Meets the Highest Standards

The American Boat & Yacht Council has established rigorous safety standards for seating hardware. Since seating is the critical interface between a boating passenger and a safe and comfortable boat, we meet ABYC standards to ensure strength and safety of every product.

To make specifying simple, we've created a coding system for each seat type. Throughout this catalog, each code listed in the table shows the rating applied to individual hardware.

Seat Type: AN, Non-Operator

(Not to be used at the helm/driver position)

ABYC Requirements:

- 31.7.4.2 Seat swivel locking mechanisms, when locked, shall not rotate relative to the seat base when subjected to a torque of 30 ft-lb (41 Nm).
- 31.4.10 Type A Seat - a seated designated occupant position while the vessel is underway at any boat speed.
- 31.7.1 All Type A adjustable seat slide and swivel mechanisms shall be provided with a locking means for its slide and swivel operations.
- 31.7.2 Seats with fore/aft adjustment must sustain static load of 300 lbs. for 3 minutes in mid position.
- 31.7.3 Operator seats with a vertical adjustment feature shall have a positive vertical locking mechanism. EXCEPTION: Seats equipped with a pneumatic or electrical vertical adjustment feature that permits the seat to be set in any vertical position throughout its vertical range of travel.

Seat Type: AO, Operator

(Used at the helm/driver position)

ABYC Requirements:

- 31.7.4.3 All operator's seats shall have a positive locking mechanism that permits the seat to be locked in the forward facing position and any other intended position(s) and capable of withstanding 150 ft-lb (205 Nm) of torque.
- 31.7.6.2 All seats interchangeable with the operator's seat must meet the requirements of this section.
- 31.4.10 Type A Seat - a seated designated occupant position while the vessel is underway at any boat speed.
- 31.7.1 All Type A adjustable seat slide and swivel mechanisms shall be provided with a locking means for its slide and swivel operations.
- 31.7.2 Seats with fore/aft adjustment must sustain static load of 300 lbs. for 3 minutes in mid position.
- 31.7.3 Operator seats with a vertical adjustment feature shall have a positive vertical locking mechanism. EXCEPTION: Seats equipped with a pneumatic or electrical vertical adjustment feature that permits the seat to be set in any vertical position throughout its vertical range of travel.

Seat Type: B

(Not to be used at the helm/driver position)

ABYC Requirements:

- 31.4.11 Type B Seat - a seated designated occupant position at boat speeds not exceeding five miles per hour.

Exceptions:

- 31.1 ABYC H31 standards do not apply to canoes, kayaks, sailboats, inflatables, race boats, tiller steered boats and boats rated for less than 10 horsepower or manual propulsion.

ABYC H31 Seat Standards

General requirements for all seat types. (AO, AN, B)

- 31.5.1 Seats that are readily removable from permanently installed bases shall be provided with a means for securing the seat, columns, pedestal, etc to prevent unintentional detachment from its installed position.
- 31.5.2 Seats not intended to be in an installed position at speeds over five miles per hour shall have a means of securing any readily removable component of a seat assembly (e.g., seat, column, pedestal, etc) when removed from its installed position.
- 31.9 All seat components meet ABYC structural testing requirements (final determination of compliance with standard is "as installed" by the boat manufacturer).

Specific ABYC requirements are based on the specific seat type.

Go to attwoodmarine.com for updated requirements.

The Factors of Seating Comfort

What makes a seat comfortable? The answer becomes complex as boating becomes more specialized and boaters more sophisticated. As your seating expert, Attwood stays ahead of design trends. In the columns below we list the universal and specialized comfort factors you should look for in any seat you choose.

Universal Factors

Contouring

- The seat's backrest follows the natural curve of the spine
- An upward curve at the back of the seat pan rotates the pelvis forward and properly positions the lumbar region
- A rounded front ("waterfall") edge reduces pressure on the thighs

Backrest Angle

- The seat relieves pressure by shifting upper body weight to the backrest, while not reducing support. This is done by angling the seat and seat mount
- Optimal seat pan-to-backrest angle is 95° -105° for passengers, 95° - 100° for drivers

Seat Height

- Pedestal height is critical for comfort and driver's vision. If too low: weight shifts onto the sitting bones. If too high: weight shifts onto back of the thighs and into the spine
- Seat height should be adjustable within a 5" range — 14-1/2" to 19-1/2" above the deck

Proper Dimensions

- Seats should fit a range of body sizes
- Attwood's seats accommodate body frames ranging from small (5th percentile female) to large (95th percentile male)

Specialized Factors

Shock Absorption

- Attwood was the first to create effective shock absorption that isolates the boater's spine from hull pounding. Attwood accomplishes this through our two revolutionary seating suspension systems. Both take a 4G hit without transferring shock to the rider by providing 3-inches of travel for a soft landing without bottoming out.

Cushioning

- On Attwood seats, the right amount of sculpted foam enhances the comfort and support already designed into the ergonomic contour
- If foam is too thick, the body "swims" without support, and movement is restricted
- If the foam is soft or thin, it "bottoms out," leading to discomfort or injury

Breathability

- Venture folding fishing seats have ventilated seat back and pan to allow pass-through of air and water for increased comfort

Accessories

- A flip-up bolster can add height and improve the field of vision for maneuvering



SAS and 4G Mesh SAS Suspensions Provide

Dynamic Comfort Underway

While underway, both SAS suspension types absorb up to 4Gs of impact from waves and hull pounding.

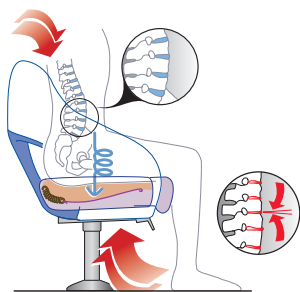

With Suspension
Impact is absorbed by the suspension — not the boater.

Without Suspension
Repeated impact can cause pain and chronic disk injury.

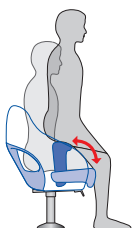

Static Comfort for Relaxing

Even while idle and sitting still, the SAS suspension adjusts to pressure and adds long term comfort.

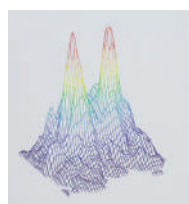
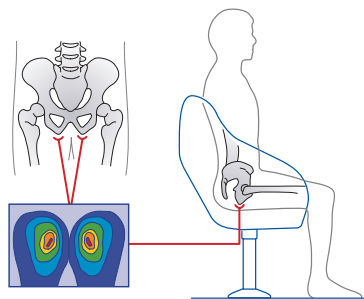

Conventional Seat
Graphs show that conventional seats allow pressure points and impaired circulation around sharp "sitting bones".

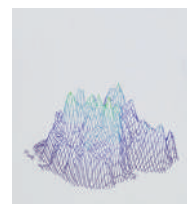

Seat with Suspension
The Attwood suspensions have stretching action to minimize pressure points.

Seating Offerings

Page #	OEM Part #	Part #	Material
Aergo (Kits)			
214	98961-1	—	Plastic/Foam
	98963-1	—	Plastic/Foam
	98990-1	—	Plastic/Foam
	98991-1	—	Plastic/Foam
Avenir (Components)			
215	98201-1	—	Plastic
	98202-1	—	Plastic
	98203-1	—	Plastic
	98204-1	—	Plastic
	7060-1	—	Plastic
	7040-1	—	Plastic
	ATT103	—	Foam
	ATT101	—	Foam
	ATT102	—	Foam
	ATT109	—	Foam
	ATT110	—	Foam
Casting Seats			
213	—	98505WH	White Vinyl
	—	98505CA	Camo Vinyl
	—	98505GY	Gray Vinyl
Centric X (Components)			
216	98900-1	—	Plastic
	98908-1	—	Plastic
	98910-1	—	Plastic
	ATT200-1	—	Foam
	ATT205-1	—	Foam
217	ATT210-1	—	Foam
	98100-1	—	Plastic
	98120-1	—	Plastic
	7009-1	—	Plastic
	7006-1	—	Plastic
	98124	—	Plastic
	ATT001	—	Foam
	ATT008	—	Foam
218	ATT009	—	Foam
	ATT016	—	Foam
	ATT002	—	Foam
	ATT007	—	Foam
	Molded Bucket Seat		
213	—	98390GY	Plastic
Venture™ (Seat Shell Only)			
213	97100-001-1	97100-001-2	White Plastic
	97100-005-1	97100-005-2	Gray Plastic
	97100-006-1	97100-006-2	Olive Plastic



Fishing Seats

Venture™ Folding Fishing Seat

The Venture folding fishing seat is designed to satisfy the widest possible range of boaters and boat builders. Mounts in any location on bass boats, aluminum fishing boats, fish'n ski, pontoon and deck boats. Its advanced styling distinguishes it from all other seats on the market.

Ventilated

Seat back and pan are ventilated to allow pass-through of air and water for increased comfort.

Portability

Venture quickly folds away to allow more room for activity and fishing excitement. Then it can be easily removed and transported using the built-in carry handle.

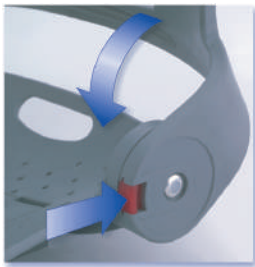

Simple, Pinch-Proof Hinge and Lock Push-button release automatically locks the seat back in upright sitting position or the folded position for transport.



97100-005

Seat Shell Only

Color	ABYC Code	OEM Part #	Part #
White	B	97100-001-1	97100-001-2
Medium Gray	B	97100-005-1	97100-005-2
Olive	B	97100-006-1	97100-006-2

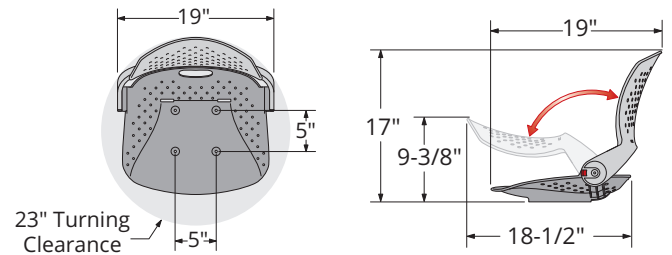

98390GY

Molded Bucket Seat

This one piece molded plastic boat seat is made from high-impact plastic. Seat includes mounting screws. 18"W x 21"D x 16"H.

Color	ABYC Code	OEM Part #	Part #
Gray	B	—	98390GY

B (Not to be used at the helm/driver position)

See page 210 for ABYC Requirements



98505WH



98505GY



98505CA

Casting Seats

This casting seat is constructed with quality materials and workmanship. Made with marine-grade vinyl, it offers long-term support and comfort. A universal casting seat, it works with any casting seat application. Available in white, gray or camo. 15"W x 11"D x 6"H.

Color	ABYC Code	OEM Part #	Part #
White	B	—	98505WH
Camo	B	—	98505CA
Gray	B	—	98505GY

Seating Systems

Aergo Seat Systems

These Aergo Kits contain all the molded foam and plastic in one! Our 4G Mesh SAS Shock Absorbing System and molded-in armrests give extra functional elements to the design and ergonomic comfort of this seat. These kits contain the molded core, pan, and bolster plastic and foam pieces. You can choose either the standard kit, which contains standard bolster foam, or the large bolster kit which has larger bolster foam for added comfort during elevated seating.

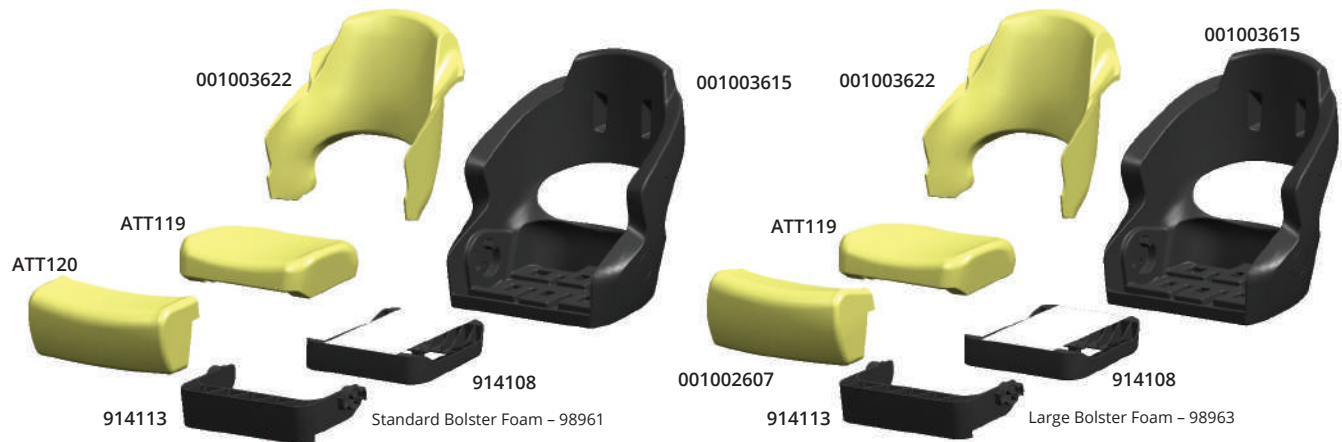

Aergo 240 Kits

Description	ABYC Code	OEM Part #	Part #
Aergo 240 Kit with standard bolster	AO, AN	98961-1	—
Aergo 240 Kit with large bolster	AO, AN	98963-1	—



Aergo 220 Kits

Description	ABYC Code	OEM Part #	Part #
Aergo 220 Kit with standard bolster	AO, AN	98990-1	—
Aergo 220 Kit with large bolster	AO, AN	98991-1	—

AN: Non-Operator (Not to be used at the helm/driver position)
AO: Operator (Used at the helm/driver position)

See page 210 for ABYC Requirements

Avenir™ Sport & Avenir™ Seat Systems

Avenir molded seating components have just four interlocking parts. This easy-to-install design, along with the universal hole pattern, reduces your upholstery and installation costs. Avenir uses marine-grade materials, a thermoplastic shell, and a stainless steel suspension grid with corrosion proof springs. These components utilize a shell and backrest upholstery insert which speeds up the upholstery of the seat shell and provide an easy means of adding stylish accent piece with deep-tuck seam. Onsert posts snap securely into the seat shell using foolproof clips for a quick and easy assembly.



Avenir Complete Kits

Description	Includes	ABYC Code	OEM Part #	Part #
Avenir Sport Kits				
Standard	ATT101, ATT102, ATT110, 7034, 7043, 7044	AO, AN	98201-1	—
Lumbar	7033, ATT101, ATT102, ATT110, 7034, 7043, 7044	AO, AN	98202-1	—
Headrest	7032, ATT101, ATT102, ATT109, 7034, 7043, 7044	AO, AN	98203-1	—
Avenir Midback Kit				
Avenir Midback Kit	7040-1, 7023, 7041, 7043, 7044, 7060-1, ATT101, ATT102, ATT103	AO, AN	98204-1	—



Avenir Upholstery Trim Rings

Avenir Upholstery Trim Rings provide a finished cap to cover seam where mesh and vinyl meet in ventilation holes at back of seat.

Description	ABYC Code	OEM Part #	Part #
Avenir Midback Trim Rings			
Left Side Trim Ring, White Plastic	AO, AN	7060-1	—
Right Side Trim Ring, White Plastic	AO, AN	7040-1	—



Avenir Molded Foam Packs

Molded foam packs are contoured specifically to enhance an ergonomic design for maximum comfort and style. Eliminates labor-intensive and costly cut foam and provides a consistent shape that improves the quality of the upholstered seat.

Description	For Use with Component	ABYC Code	OEM Part #	Part #
Avenir Midback Foam Packs				
Avenir Midback Backrest Foam	—	AO, AN	ATT103	—
Seat Pan Foam Packs				
SAS Seat Pan	—	AO, AN	ATT101	—
Bolster Foam Packs				
Flip-up Bolster	—	AO, AN	ATT102	—
Avenir Sport Foam Packs				
Avenir Sport Backrest with Headrest	—	AO, AN	ATT109	—
Avenir Sport Backrest with Lumbar Option	—	AO, AN	ATT110	—

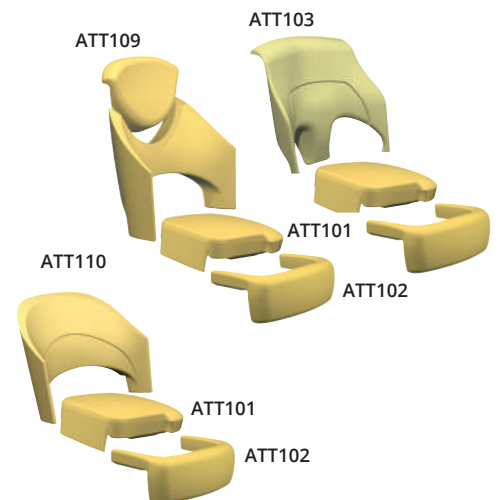

For questions regarding Attwood's most up-to-date seating selections, or for assistance with your seating application, contact your Sales Representative or Attwood Customer Service

AN: Non-Operator (Not to be used at the helm/driver position)

AO: Operator (Used at the helm/driver position)

See page 210 for ABYC Requirements

Centric X Seat Systems

These sleek, functional, and ergonomically designed seats provide the new look you've been looking for in folding fishing or helm seats! Just choose the base plastic kit that suits your functional needs. Then choose a stylish foam kit and complete your look.



98900



98910

Centric X Seat Shell Kits

Centric X seat shell kits contain all plastic components to assemble. Base pieces include corrosion-resistant T-nuts for pedestal attachment. Kits include assembly hardware.

Description	For Use with Foam Pack	ABYC Code	OEM Part #	Part #
Non-SAS, Gray	ATT200-1, ATT205-1, or ATT210-1	AO, AN	98900-1	—
Non-SAS, Dark Gray	ATT200-1, ATT205-1, or ATT210-1	AO, AN	98908-1	—
Non-SAS, Duck	ATT200-1, ATT205-1, or ATT210-1	AO, AN	98910-1	—

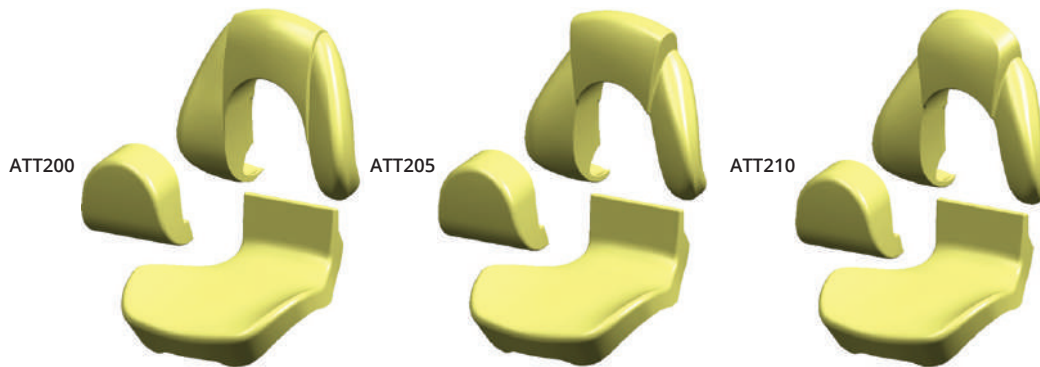

Centric X Molded Foam Packs

Centric X molded foam kits come in a variety of shapes to fit your individual styling needs.

Description	ABYC Code	OEM Part #	Part #
Non-SAS Standard Foam Pack	AO, AN	ATT200-1	—
Non-SAS Flared Headrest Foam Pack	AO, AN	ATT205-1	—
Non-SAS Rounded Headrest Foam Pack	AO, AN	ATT210-1	—

For questions regarding Attwood's most up-to-date seating selections, or for assistance with your seating application, contact your Sales Representative or Attwood Customer Service

AN: Non-Operator (Not to be used at the helm/driver position)

AO: Operator (Used at the helm/driver position)

See page 210 for ABYC Requirements

Centric Seat Systems

With all of its features, Centric is surprisingly easy to upholster using our molded foam packs. Centric seat components consist of blow-molded fishing or helm seat cores, injection molded upholstery inserts for the backrest and seat back hinge cover, and molded foam packs.

Centric Seat Core Kits

Centric seat core kits include the seat pan with a choice of Mid-Back and High-Back backrest styles. Each seat includes a separate seatback insert to cover and protect the hinge. Insert can be applied and then upholstered over with the rest of the seatback or upholstered separate of the seatback as a means of providing an accent piece. Seat cores include corrosion-resistant T-nuts for attachment to seat pedestals.

Centric Upholstery Inserts

The Upholstery Inserts speed up the upholstery of the backrest and provide an easy means of adding a stylish accent piece with deep-tuck seam. Insert posts snap securely into seat core using foolproof clips for quick, easy assembly.



Description	For Use with Foam Packs	ABYC Code	OEM Part #	Part #
Seat Cores and Inserts				
Mid-Back Core, Black	ATT001, ATT002, ATT007	AO, AN	98100-1	—
High-Back Core, Black	ATT007, ATT008	AO, AN	98120-1	—
Mid-Back Onsert	ATT009	AO, AN	7009-1	—
High-Back Onsert	ATT008	AO, AN	7006-1	—
Mid-Back II Onsert	ATT016	AO, AN	98124	—

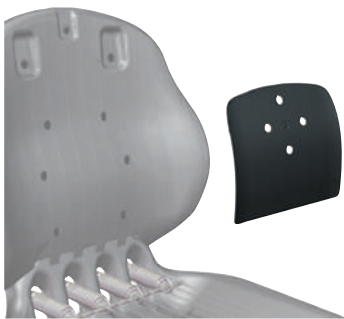

AN: Non-Operator (Not to be used at the helm/driver position)

AO: Operator (Used at the helm/driver position)

See page 210 for ABYC Requirements

Centric Molded Foam Packs

Molded foam packs are contoured to enhance the ergonomic shape of Centric's seat core for maximum comfort and style. Eliminates labor-intensive and costly cut foam and provides a consistent shape that improves the quality of the upholstered seat. Centric foam packs are offered with a choice of integrated "hook and loop" or "onsert" upholstery methods.

Hook and Loop - Joins upholstery seam-to-foam to form a moderate tuck.

Onserts - provide a deep tucked seam depth by using a separate upholstered panel.



ATT001



ATT008



ATT009

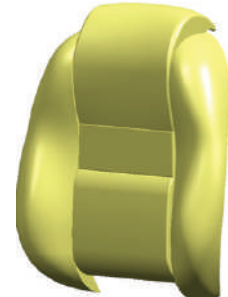

ATT016

Description	For Use with Component(s)	ABYC Code	OEM Part #	Part #
Backrest Foam Packs				
Mid-Back, Hook & Loop	98100	AO, AN	ATT001	—
High-Back, w/Onsert	98120, 7006	AO, AN	ATT008	—
Mid-Back, w/Onsert	98100, 7009	AO, AN	ATT009	—
Mid-Back II Foam Pack	98121, 98124	AO, AN	ATT016	—
Seat Pan Foam Packs				
Sport Weight Hook & Loop	98100, 98200, 98120, 98121	AO, AN	ATT002	—
Luxury Weight Hook & Loop	98100, 98200, 98120, 98121	AO, AN	ATT007	—

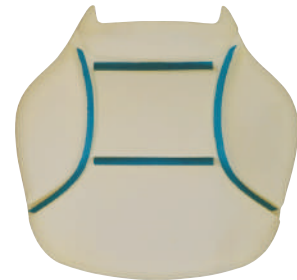

ATT002

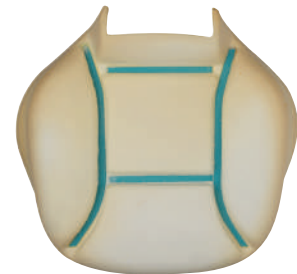

ATT007

For questions regarding Attwood's most up-to-date seating selections, or for assistance with your seating application, contact your Sales Representative or Attwood Customer Service.

AN: Non-Operator (Not to be used at the helm/driver position)

AO: Operator (Used at the helm/driver position)

See page 210 for ABYC Requirements

Pedestal Systems & Accessories

278 Series Pedestal System Strong. Stable. Smooth.

Unmatched Strength.

- Heavy-duty casting easily supports popular oversized helm seats.

Supreme Stability.

- A rigid mount and wider seat interface create ultimate pedestal robustness.

Extra Smooth.

- Improved slider motion facilitates easy fore and aft movement. Dampening gas spring on the 278 Air System absorbs impact.



278 Pro System
Fixed Height Pedestal

278 Air System
Adjustable Height Pedestal

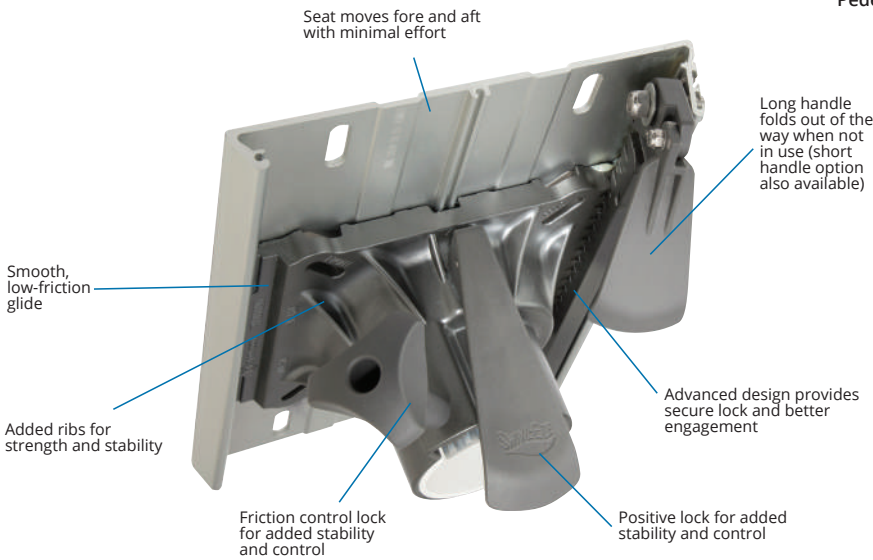

Dimensions of 278 Pro & 278 Air Systems
NOTE: 278 Pro & 278 Air System components are not compatible with other seating systems.

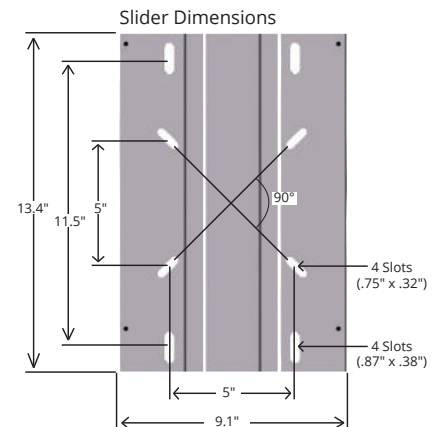
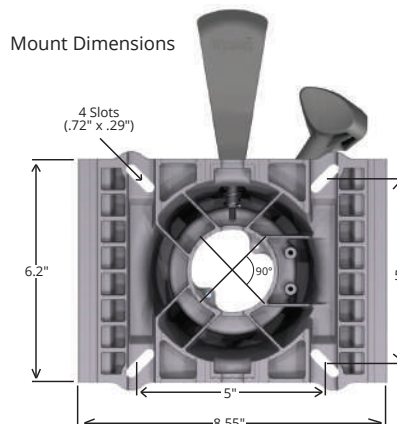
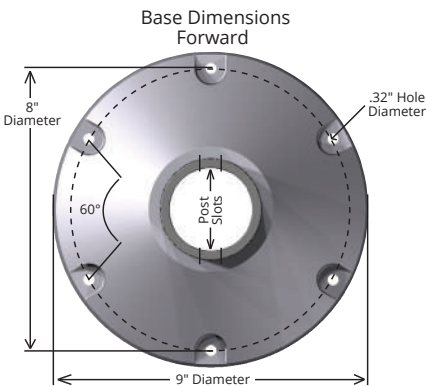
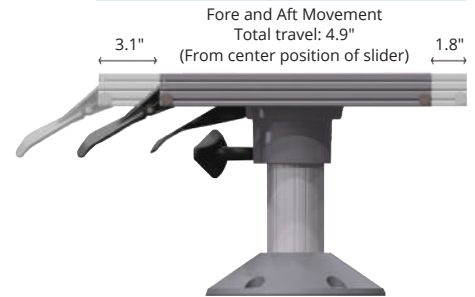

278 Air System (Adjustable Height Pedestal)

Description	ABYC Code	Base Height	Slider Handle	Base Finish	OEM Part #
Bases (For total system height, add 1" to the base height)					
278 Air Pedestal Base, 2.75" Below Deck	AO	9-12"	—	Gray	278AOP0912-BD-1
278 Air Pedestal Base	AO	12-15"	—	Gray	278AOP1215-1
278 Air Pedestal Base	AO	15-19"	—	Gray	278AOP1519-1
278 Air Pedestal Base	AO	19-23"	—	Gray	278AOP1923-1
Seat Mounts					
278 Air Mount, 3 degree	AO	—	—	—	278AO3AM-1
278 Air Mount, 0 degree	AO	—	—	—	278AOZAM-1
278 Mounts with Slider					
278 AirGlide Slider, 0 degree	AO	—	Short	—	278AOZAGS-1
278 AirGlide Slider, 0 degree	AO	—	Long	—	278AOZAGL-1
278 AirGlide Slider, 3 degree	AO	—	Short	—	278AO3AGS-1
278 AirGlide Slider, 3 degree	AO	—	Long	—	278AO3AGL-1



278 Air Pedestal Base

278 Air Pedestal Base, Below Deck



278 Air Mount



278 AirGlide Slider, Short Handle



278 AirGlide Slider, Long Handle



278 Pro Pedestal Base, Low Profile



278 Pro Pedestal Base



278 Pro Mount, AN



278 Pro Mount, AO



278 ProGlide Slider, Long Handle

278 Pro System (Fixed Height Pedestal)

Description	ABYC Code	Base Height	Slider Handle	Base Finish	OEM Part #
Bases					
278 Pro Pedestal Base, Low Profile	AO	5"	—	Bright	—
278 Pro Pedestal Base	AO	6"	—	Gray	278AOGY060-1
278 Pro Pedestal Base	AO	7"	—	Gray	278AOGY070-1
278 Pro Pedestal Base	AO	8"	—	Gray	278AOGY080-1
278 Pro Pedestal Base	AO	9"	—	Gray	278AOGY090-1
278 Pro Pedestal Base	AO	10"	—	Gray	278AOGY100-1
278 Pro Pedestal Base	AO	11"	—	Gray	278AOGY110-1
278 Pro Pedestal Base	AO	12"	—	Gray	278AOGY120-1
278 Pro Pedestal Base	AO	13"	—	Gray	278AOGY130-1
Seat Mounts					
278 Pro Mount, 3 degree	AN	—	—	—	278ANZPM-1
278 Pro Mount, 0 degree	AO	—	—	—	278AOZPM-1
278 Pro Mount, 3 degree	AO	—	—	—	278AO3PM-1
Seat Mounts with Slider					
278 ProGlide Slider, 3 degree	AO	—	Long	—	278AO3PGL-1
278 ProGlide Slider, 0 degree	AO	—	Long	—	278AOZPGL-1

AN: Non-Operator (Not to be used at the helm/driver position)

AO: Operator (Used at the helm/driver position)

See page 210 for ABYC Requirements

238 Series 2-3/8"

Strength, style and corrosion-resistance

- Pedestal tubes are hard-anodized aluminum
- All springs are stainless steel
- Bases are bead-blasted (to close aluminum porosity) and clear coated

Smooth movement without wobble

- Slider has gear-tooth lock mechanism; locks solidly, disengages easily
- Slider rides smoothly on acetal linear bearings

Clean style, ergonomic design

- Styling is clean and uncomplicated
- Handles are ergonomically designed to be easy on the hands and easy to reach

Not recommended to interchange with other manufacturers' products



Reinforced polymer handle is thicker for strength and more comfortable grip.

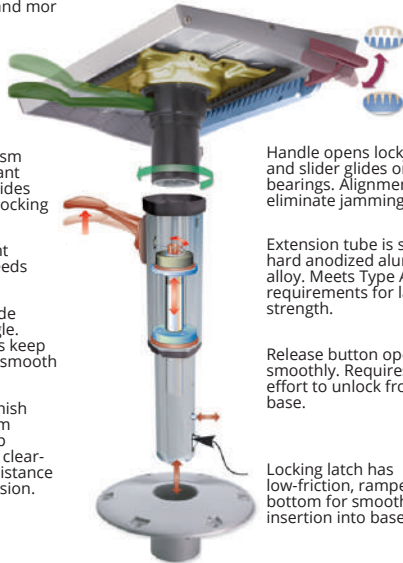

Seat mount mechanism is redesigned. Constant pressure spring provides continuous forward locking pressure.

Cable-actuated height mechanism never needs adjustment.

Linear grooves provide support, reduce wiggle. Acetal linear bearings keep the whole operation smooth and wobble free.

Bead-blasted base finish pounds the aluminum surface and closes up porosity. Proprietary clear-coating improves resistance to scuffing and corrosion.

Handle opens lockjaw gears... and slider glides on acetal linear bearings. Alignment tracks eliminate jamming and wobbling.

Extension tube is super-hard anodized aluminum alloy. Meets Type A Driver requirements for lateral strength.

Release button operates smoothly. Requires less effort to unlock from base.

Locking latch has low-friction, ramped bottom for smooth insertion into base.

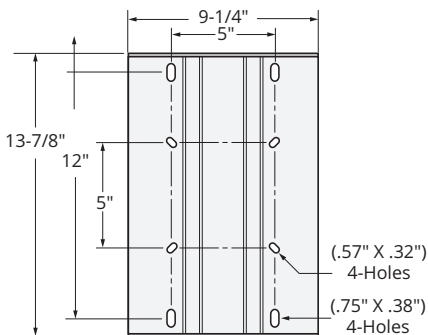

238 Pedestal Kits

Attwood's 2-3/8" pedestal kit is strong, durable, and corrosion resistant. The kit includes a 360 degree swivel seat mount, removable extension post, and 9" base. Available in satin aluminum or Realtree MAX-4 Camouflage.

Description	ABYC Code	Req. Dia. Mounting Hole	OEM Part #	Part #
Base Plate: 9", Seat Mount 5" X 5" on Center				
Pedestal Kit with 9" Satin Post	AO	3"	—	23809-7
Pedestal Kit with 11" Satin Post	AO	3"	—	23811-7
Pedestal Kit with 13" Satin Post	AO	3"	—	23813-7
Pedestal Kit with 15" Satin Post	AO	3"	—	23815-7



238 Series Seat Mounts

Description	ABYC Code	OEM Part #	Part #
Seat Mounts without Slider			
Stainless Steel, 3° Tilt, Left Handle	AO	238141-1	—
Stainless Steel, 3° Tilt, Right Handle	AO	238142-1	238142-7
Plated Steel, 0° Tilt, Left Handle	AO	238150-1	—
Plated Steel, 3° Tilt, Left Handle	AO	238151-1	—
Plated Steel, 3° Tilt, Right Handle	AO	238152-1	238152-7
Plated Steel, 3° Tilt, Forward Handle	AO	238153-1	238153-7
Seat Mounts with Aluminum Slider			
Plated Steel, 3° Tilt, Right Handle	AO	238162-1	238162-4
Plated Steel, 0° Tilt, Right Handle	AO	238164-1	—

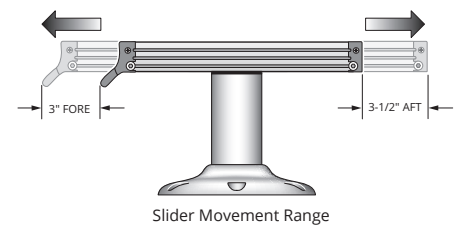

AO: Operator (Used at the helm/driver position)

See page 210 for ABYC Requirements

238 Series Pedestals & Extension Posts

Description	ABYC Code	OEM Part #	Part #
Fixed Height Bell Pedestals*			
8" Height	AO	238908-1	—
11" Height	AO	238911-1	—
12" Height	AO	238912-1	—
13" Height	AO	238913-1	—
15" Height	AO	238915-1	—
Fixed Height Extension Posts*			
8" Height	AO	238608-1	—
9" Height	AO	238609-1	—
10" Height	AO	238610-1	238610-3
11" Height	AO	238611-1	—
12" Height	AO	238612-1	238612-3
13" Height	AO	238613-1	238613-3
14" Height	AO	238614-1	—
15" Height	AO	238615-1	238615-3
17" Height	AO	238617-1	—
25" Height	AO	238625-1	—
30" Height	B	238630-1	—
	B	238630L1	—
Pro-Pole Extension Posts - Type B*			
27" Height	B	238027-1	238027-3
Adjustable Height Power Pedestals*			
13" to 16-1/2" Height	AO	238512-1	238512-4
19-1/2" to 23" Height	AO	238522-1	238522-4

* Height measured from deck to top of seat mount



238908



238617



238512



238609

238 Series Socket Bases

Bases are interchangeable between LakeSport 238 Series and 238 Series.

Description	ABYC Code	Req. Dia. Mounting Hole	OEM Part #	Part #
Aluminum 9" Round, Clear Coat Finish	AO	3"	238312-1	238312-2
Aluminum 9" D-Shaped, Clear Coat Finish	AO	3"	238322-1	—
Stainless Steel, 7" x 7", Square, Centered Hole	AO	3"	238333-1	—
Aluminum 9" Cut Both Sides, Clear Coat Finish	AO	3"	238352-1	—
238 Series Socket Base Splash Guard				
Socket Splash Guard, Plastic	AO	—	238300-1	—

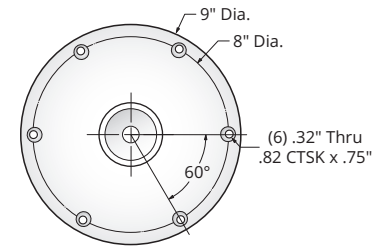

238312



238352

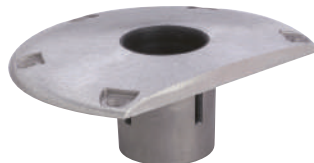

238322



238333



238300

AO: Operator (Used at the helm/driver position)

B (Not to be used at the helm/driver position)

See page 210 for ABYC Requirements

LakeSport 238 Series

The Difference

- These sturdy 2-3/8" diameter pedestal systems have all the strength and durability you need for years of family fishing enjoyment.
- Hard anodized aluminum pedestal tubes
- Bead blasted finish pounds the aluminum surface and closes up porosity
- All LakeSport 238 Series hardware is engineered to meet ABYC standards

Type A/Operator Models lead the industry with these features:

- Ergonomic positive-locking handle with stainless steel components



818440



818441



828461

LakeSport 2-3/8" Seat Mounts

Description	ABYC Code	OEM Part #	Part #
Seat Mounts Without Slider Installed Height: 5/8"			
Aluminum, w/ Friction Control, 3° Tilt	AN	818440	—
Aluminum, w/ Friction Control, 3° Tilt	AO	818441	818441-3
Seat Mounts with Aluminum Slider Installed Height: 1"			
Aluminum, w/ Friction Control, 3° Tilt	AO	828461	—

LakeSport 2-3/8" Extension Posts

For LakeSport seat mounts only

Description	ABYC Code	OEM Part #	Part #
Fixed Height Extension Posts*			
10" Height, Anodized Finish	AN	238610L1	—
11" Height, Anodized Finish	AN	238611L1	—
13" Height, Anodized Finish	AN	238613L1	—

* Height measured from deck to top of seat mount



238610L1

AN: Non-Operator (Not to be used at the helm/driver position)

AO: Operator (Used at the helm/driver position)

See page 210 for ABYC Requirements

LakeSport 2-3/8" Seat Pedestals

Description	ABYC Code	OEM Part #	Part #
Hydraulic Power Pedestals with Seat Mount*			
12" - 15" Adjustable Height, Anodized Finish	AO	238813LSM1	—
25" - 32" Adjustable Height, Anodized Finish	B	238833LSM1	—
Fixed Height Bell Pedestals*			
11" Height	AO	238911L1	—
13" Height	AO	238913L1	—
Fixed Height Bell Pedestals with Seat Mount*			
9" Height	AN	238909LSM1	—
13" Height	AN	238913LSM1	—
16" Height	AN	238916LSM1	—
Adjustable Height Bell Pedestals with Seat Mount, Manual*			
14"-20" Adjustable Height, Anodized	AN	—	2385400
12-1/2"-15-1/2" Adj. Height, J-Slot, Anodized	AO	—	2385405

* Height measured from deck to top of seat mount



LakeSport 2-3/8" Socket Bases

Bases are interchangeable between LakeSport 238 Series and 238 Series.

Description	ABYC Code	Req. Dia. Mounting Hole	OEM Part #	Part #
Aluminum 9" Round, Clear Coat Finish	AO	3"	238312-1	238312-2
Aluminum 9" D-Shaped, Clear Coat Finish	AO	3"	238322-1	—
Stainless Steel, 7" x 7", Square, Centered Hole	AO	3"	238333-1	—
Aluminum 9" Cut Both Sides, Clear Coat Finish	AO	3"	238352-1	—
238 Series Socket Base Splash Guard				
Socket Splash Guard, Plastic	AO	—	238300-1	—

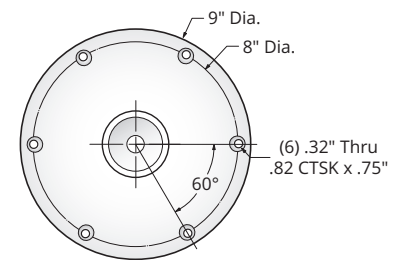

AN: Non-Operator (Not to be used at the helm/driver position)

AO: Operator (Used at the helm/driver position)

B (Not to be used at the helm/driver position)

See page 210 for ABYC Requirements

Wedge 2" & 2-3/8"

Wedge shaped components slide in for a snug, stable fit

- Type B mounts are not designed to "lock" into post
- Engineered to prevent unintentional detachment

Posts

- Heavy-duty bushing with peripheral bearing system and exclusive "crush ribs" are individually sized for exact fit
- Pedestals come in a few lengths, including patented "J-Slot" adjustable height
- Locking tab positively locks post to base
- Wedge™ bushing locks in with a tight, solid fit
- 2-Point stainless steel riveting strengthens the bushing

Bases

- Strong base design has reinforcing ribs and improved profile to withstand the toughest conditions
- Bead blasting closes aluminum porosity. Brushing process provides long-lasting high-shine finish

Not recommended to interchange with other manufacturers' products

Wedge 2" Seat Mounts

Description	ABYC Code	Installed Height	OEM Part #	Part #
Cast Aluminum, Black E-Coat Steel, 3° Tilt	B	3"	—	SP-18914



SP-18914

Wedge 2" Extension Posts

Description	ABYC Code	OEM Part #	Part #
2" Fixed Height Posts			
11" Satin Anodized	B	—	SP-28911
13" Satin Anodized	B	—	SP-28913

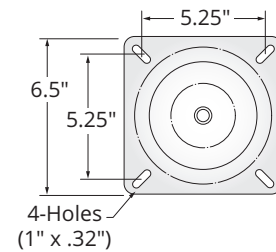

Wedge 2-3/8" Extension Posts

Description	ABYC Code	OEM Part #	Part #
2-3/8" Adjustable Height Posts - Power Pedestals (w/ Integral Seat Mount)			
14" - 20" Satin Anodized	B	—	SP-37904
24" to 30" Satin Anodized	B	—	SP-37914



SP-28911

SP-37904

Wedge 2" Base Plates

Description	ABYC Code	Req. Dia. Mounting Hole	Depth Below Deck	OEM Part #	Part #
9" Round, Brushed Aluminum	AO	3.25"	2"	—	SP-68914



SP-68914

AO: Operator (Used at the helm/driver position)

B (Not to be used at the helm/driver position)

See page 210 for ABYC Requirements

Lock'N-Pin 3/4" Pin



#1 supplier of 3/4" pin seating hardware. Here's why:

- The 3/4" system gives you outstanding economical performance
- The design is proven by decades of experience
- Posts are available as fixed, manually adjustable or power adjustable
- Seat mounts, posts and bases are available in steel, aluminum or stainless steel

The Difference

- The patented Lock'N-Pin system leads the industry in safety
- Lock'N-Pin prevents unintentional detachment for seat mounts, posts and bases
- Lock'N-Pin products meets ABYC Standard H31.6.1

Not recommended to interchange with other manufacturers' products

Lock'N-Pin 3/4" Pedestal Packages

Includes Brushed aluminum post, black E-coated seat mount with Spring & Base Plate.

Description	Post	Base 7"x7"	ABYC Code	Post	Seat Mount	Base Plate	OEM Part #	Part #
Non-Threaded	11"	SS Base Plate	B	2114	1002	67739	—	97739
Threaded	11"	SS Base Plate	B	2114-T	1002	67739-T	—	97739-T
Threaded	13"	SS Base Plate	B	2134-T	1002	67739-T	—	977339-T
Brushed Aluminum Finish Kit, Non-Threaded	11"	Aluminum Base Plate	B	2114	1002	67749	—	97749-7
Camouflage Finish Kit, Non-Threaded	11"	Aluminum Base Plate	B	2114	1002	67749	—	97749C-7



97749-7

97749C-7

Lock'N-Pin 3/4" Pin Seat Mounts

Description	Tilt	Pin	ABYC Code	Installed Height	OEM Part #	Part #
Zinc-plated	3°	2-3/4" Steel Pin w / Spring	B	2"	—	SP-1002
Black E-Coated	3°	2-3/4" Steel Pin w / Spring	B	2"	1002	—
Black E-Coated	3°	2-1/2" Steel Pin	B	1"	1002-S	—
All Stainless Steel	3°	2-3/4" Stainless Steel Pin	B	1"	1002-SS	—



1002



1002-SS

075 Pedestal Kits

Take the confusion out of buying pedestals with these convenient 3/4" pin kits. Kits include seat mount, post and 7" x 7" base. Simply choose the appropriate post height and finish. Attwood's 3/4" pin kit is corrosion resistant, features a 360 degree swivel, a shock absorbing spring, and a removable pin post. Lock 'N' Pin technology features an all steel pin, increasing pedestal strength and durability. Available in brushed aluminum or Realtree MAX-4 camouflage.

Description	ABYC Code	OEM Part #	Part #
Base Plate: 7" x 7", Seat Mount 5-1/4" X 5-1/4" on Center			
Add 3" to post height to get total height, measured from deck to seat			
13" Brushed Aluminum Post	B	—	97750-7
13" Realtree MAX-4 Camouflage Post	B	—	97750C-7

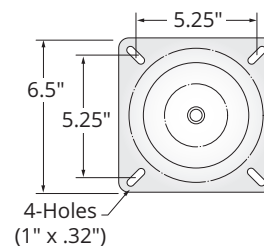

B (Not to be used at the helm/driver position)

See page 210 for ABYC Requirements

Lock'N-Pin 3/4" Pin Posts

Height	Dia	Pin	ABYC Code	OEM Part #	Part #
Fixed Height Posts					
6"	1.5"	Brushed Aluminum Non-Threaded, Steel Pin	B	2064	—
11"	1.5"	Brushed Aluminum Non-Threaded, Steel Pin	B	2114	SP-2114
11"	1.5"	Brushed Aluminum Threaded, Steel Pin	B	2114-T	SP-2114-T
13"	1.5"	Brushed Aluminum Non-Threaded, Steel Pin	B	2134	SP-2134
13"	1.5"	Brushed Aluminum Threaded, Steel Pin	B	2134-T	SP-2134-T
13"	1.5"	Brushed Aluminum Non-Threaded, SS Pin	B	2134-SS	—
13"	1.5"	Brushed Aluminum Threaded, SS Pin	B	2134-T-SS	—
13"	1.5"	Polished SS Offset Post 6", Threaded, SS Pin	B	7153-T-SS	SP-7153-T-SS
16"	1.5"	Brushed Aluminum Non-Threaded, Steel Pin	B	2164	SP-2164
16"	1.5"	Brushed Aluminum Threaded, Steel Pin	B	2164-T	SP-2164-T
24"	1.5"	Brushed Aluminum Pro-Post, Non-Threaded, Steel Pin	B	2244	SP-2244
Adjustable Height Posts - Manual					
25"-31"	1.5"	Brushed Aluminum Pro-Post, Non-Thread, Steel Pin	B	2244-ADJ	SP-2244-ADJ
25"-31"	1.5"	Brushed Aluminum Pro-Post, Threaded, Steel Pin	B	2244-ADJ-T	SP-2244-ADJ-T
Adjustable Height Posts - Power Pedestals with Integral Seat Mounts					
14"-17"	1.77"	Brushed Aluminum Non-Threaded, Steel Pin	B	3004	SP-3004
14"-17"	1.77"	Brushed Aluminum Threaded, Steel Pin	B	3004-T	SP-3004-T
24"-30"	1.77"	Brushed Aluminum Pro-Post, Non-Thread., Steel Pin	B	3204	SP-3204
24"-30"	1.77"	Brushed Aluminum Pro-Post, Threaded, Steel Pin	B	3204-T	SP-3204-T
24"-30"	1.77"	Brushed Aluminum Pro-Post, Threaded, SS Pin	B	3204-T-SS	—
Adjustable Height Posts - Power Pedestals for Use with 3/4" Pin Seat Mounts					
15"-18"	1.77"	Brushed Aluminum Non-Threaded, Steel Pin	B	3004-R	SP-3004-R
15"-18"	1.77"	Brushed Aluminum Threaded, Steel Pin	B	3004-R-T	SP-3004-R-T
15"-18"	1.77"	Brushed Aluminum Threaded, SS Pin	B	3004-R-T-SS	—
24"-30"	1.77"	Brushed Aluminum Non-Threaded, Steel Pin	B	3204-R	SP-3204-R
24"-30"	1.77"	Brushed Aluminum Threaded, Steel Pin	B	3204-R-T	SP-3204-R-T
24"-30"	1.77"	Brushed Aluminum Threaded, SS Pin	B	3204-R-T-SS	—



B (Not to be used at the helm/driver position)

See page 210 for ABYC Requirements

Lock'N-Pin 3/4" Pin Bases

Description	Bushing	ABYC Code	Req. Dia. Mounting Hole	Depth Below Deck	OEM Part #	Part #	
Zinc Plated Steel							
6" x 8"	Non-Threaded	Bronze	B	2.75"	2.5"	6682	—
6" x 8"	Threaded	Bronze	B	2.75"	3.5"	6682-T	—
7" x 7"	Non-Threaded	Acetal	B	2.75"	2.5"	67729	—
7" x 7"	Threaded	Acetal	B	2.75"	3.5"	67729-T	SP-67739-T
Aluminum							
7" x 7", Clear Coat	Non-Threaded	Acetal	B	3.5"	2.5"	67749	SP-67749
Stainless Steel Finish with Steel Lip Tube							
3" x 4"	Non-Threaded	Acetal	B	1.5"	2.5"	63439	—
4" x 8"	Non-Threaded	Acetal	B	1.5"	2.5"	64839	SP-64839
4" x 8"	Non-Threaded	Bronze	B	1.5"	2.5"	6483	—
4" x 8"	Threaded	Bronze	B	1.5"	3.7"	6483-T	—
6" x 8"	Non-Threaded	Acetal	B	2.75"	2.5"	66839	SP-66839
6" x 8"	Threaded	Bronze	B	2.75"	3.7"	6683-T	—
6" x 12", Dual Socket	Threaded	Bronze	B	2.75"	3.7"	66123-T	—
7" x 7"	Non-Threaded	Acetal	B	2.75"	2.5"	67739	SP-67739
7" x 7"	Non-Threaded	Bronze	B	2.75"	2.5"	6773	—
7" x 7"	Threaded	Bronze	B	2.75"	3.5"	6773-T	—
7" x 7", Unfinished	Threaded	Bronze	B	2.75"	3.7"	6773-T-U	—
7" x 7", Offset Hole	Non-Threaded	Acetal	B	2.75"	2.5"	67739-SC	—
All Stainless Steel							
4" x 4"	Non-Threaded	Acetal	B	1.5"	2.5"	64439-SS	—
4" x 4", Polished	Threaded	Bronze	B	2.75"	3.7"	6443-T-P-SS	—
7" x 7"	Non-Threaded	Acetal	B	2.75"	2.5"	67739-SS	—

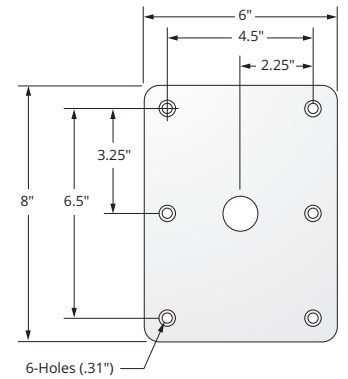
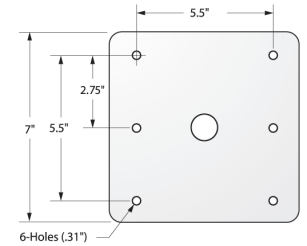

67729



67739-SC



67749



67739-SS



66839



67739



64839



6773

B (Not to be used at the helm/driver position)

See page 210 for ABYC Requirements

Pedestals, Swivels & Adapters

We have the boating experience to deliver all the accessories you want:

Seating accessories for retrofitting and improving

- Adapters to change a post installation or swivel location
- Table mounts to make boating more convenient and enjoyable

Pedestals

Little on price, big on performance

- Exceptional durability
- Reinforced welded joints
- Black powder coated for a long lasting finish

Description	OEM Part #	Part #
Pedestal, 7"	—	90720
Pedestal, 13"	—	91320
Adjustable Pedestal, 11-1/2" - 17-1/2"	—	91320-ADJ



Seat Swivels

Description	OEM Part #	Part #
Zinc Plated, 0° Tilt, 4-Way Locking	1872	—
Black Powder Coated, 0° Tilt, 6-1/4" (10 p/Box)	—	17720
Black Powder Coated, 3° Tilt, 7" (10 p/Box)	—	17721



Seat Mounts

Bench Style Seat Mounts

- Great for mounting seats in jon boats
- Constructed of quality aluminum.

Clamp-On Boat Seat Swivel

- Adjusts from 7-1/2" to 18"
- Black powder coated swivel
- Fits most seat hole patterns

Description	OEM Part #	Part #
Bench Style Seat Mounts		
Bench Style Kit: Seat Plate an 15" Rails	—	SP-15900
Bench Style Seat Plate Only	—	SP-15100
Bench Style 30" Rails Only	—	SP-15200
Clamp-On Boat Swivel		
Boat Swivel	—	15700-3



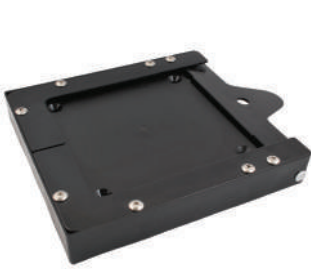

11602D1



111603D1



815000

Quick Disconnect Seat Mount

Allows for easy attachment and removal of boat seats for ease in storage and care. Produced from durable engineered plastic and coated structural steel frame for years of use. Easy to install and use, mounts directly to existing seats and standard pedestals. Perfect for Jon boats, fishing boats, pontoons and more.

Description	OEM Part #	Part #
Fits 6-1/4" (15.9 cm) swivel and plates	—	11602D1
Fits 7" (17.8 cm) swivel and plates	—	11603D1

Deck Slide

- Mounts directly to the boat deck
- 1-5/8" total height
- Constructed of strong aluminum
- Convenient front control operation

Description	OEM Part #	Part #
Deck Mounted Seat Slide	815000	—



7062

Seat Swivel Offset

Need more room to maneuver? The 6" offset allows additional seat clearance in any position.

Description	OEM Part #	Part #
Seat Swivel Offset	—	7062-3



SP-14000

Pedestal Pin Post Adapter

Converts 1.77" bases to accept 3/4" posts

Description	OEM Part #	Part #
Adapter	—	SP-14000



17525

952

Table Top Mount System

Description	OEM Part #	Part #
Brushed aluminum post with tension knob. Threaded for use in base. 25"	17525	—
6" diameter round stainless steel base, threaded Flush mounts to deck. Low profile	—	952

Part #	Page	Part #	Page	Part #	Page	Part #	Page	Part #	Page
001008199	90	11017XLP-1	168	11210	158	11524-3	31	11719-2	123
001008200	90	11018XLP-1	168	11210-1	157	11526-3	103	11720-2	123
001011094	90	11028XLP-1	168	11211-1	157	11551-5	23	11721-2	123
10001-7	167	11029-6	153	11215	157	11575-3	117	11722-2	119
10010-7	168	11029XLP-1	168	11215-1	158	11586-4	33	11723-7	119
10011-1	168	11031-5	165	11216-1	158	11591-3	33	11724-1	119
1001667	21	11034-5	165	11217-1	158	11592-3	33	11725-2	119
1001668	21	11035-5	167	11220-3	158	11595-2	23	11726-2	123
10017XL-7	168	11058-1	170	11230-1	158	11595-2	149	11728-2	121
10018XL-7	168	11059-1	170	11246-1	159	11596-2	23	11729	122
1002-5	227	11064-1	170	11247-1	159	11596-2	149	11729D5	122
1002-SS	227	11066-1	170	11252-1	158	11602D1	231	11730-7	121
1002607	214	11079-1	164	11254-1	158	11603D1	231	11732-7	122
10028XLP-7	168	11079SC-B-5	164	11282-3	159	11631-4	137	11733-7	120
10029XLP-7	168	11079SN-B	164	11283-3	159	11635-4	137	11734-1	119
10031-7	165	11080-5	163	11284-3	159	11654-3	137	11736-7	119
10035-7	167	11088-5	165	11285-3	159	5091-10-7	59	11737-7	121
10036-7	167	11090-3	159	11315-1	157	5092-10-7	59	11739-2	124
1003615	214	11095-5	164	11317-1	157	11670-4	137	11739-2	156
1003622	214	11096-5	163	11319-1	157	11672-4	137	11741-7	119
10079-7	164	11098-5	167	11360-1	158	5095-10-7	59	11742-7	119
1007923	214	11106-1	169	11361-1	158	11700-2	123	11749-7	121
10080-7	163	11107-1	169	11362-1	158	11701-7	120	11750-7	121
10082-7	166	11126-4	154	11363-1	158	11702-7	121	11752-7	121
10098-7	167	11127-4	154	11364-1	158	11703-7	121	117525-7	121
10099-7	167	11130-7	154	11368-3	159	11704-2	123	11753-7	124
10102-1	170	11147-7	156	11370-1	159	11705-7	120	117553-7	123
10104-1	169	11149-4	155	11370-7	132	11706-7	120	11756-2	148
10105-1	169	11150-5	117	11371-1	159	11707-7	119	117561-2	124
10106-1	169	111603D1	231	11372-1	159	11708-1	119	117563-7	120
10107	161	11168-5	165	11401-4	154	11709-1	119	117564-7	120
10107-1	169	11180-5	117	11404-6	199	11710-2	123	117565-7	121
10108	161	11185-5	166	11437-7	151	11711-7	120	117566-7	121
10108-1	169	11195-4	155	11438-7	151	11712-7	124	117567-7	121
10122-1	169	11196-5	163	11441-4	151	11713-2	123	11758-2	148
10224-1	170	11200-1	157	11446-1	33	11714-2	119	11759-1	147
10309	161	11201-1	157	11477-3	165	11715-7	120	11760-1	147
10524-1	169	11202-1	157	11478-7	165	11716-1	119	117601-7	120
10624-1	169	11205-1	157	11512-3	103	11717-2	123	117603-7	120
11011-7	154	11209-1	157	11524-1	31	11718-2	123	117604-7	120

Part #	Page	Part #	Page	Part #	Page	Part #	Page	Part #	Page
117605-7	120	11824	93	11971-7	122	12773-2	131	14141-7	133
117607-7	120	11826-1	135	12009-3	190	12774-2	131	14142-7	133
117608-7	120	11828-1	135	12022	190	12790-1	150	14185XFS-7	77
11761-1	147	11830-2	135	12044-6	153	12790-1	200	14187XFS-7	77
117614-7	121	11834-1	138	12048-4	117	12790-3	150	14190	77
117617-7	121	11840-7	104	12049-4	117	12790-3	200	14190-7	77
11762-1	147	11841-4	104	12100	190	12791-1	150	14191	77
117621-7	121	11843-7	122	12100L3	190	12792-1	150	14191-7	77
11764-1	147	11845-1	137	12102-1	190	12794	150	14192-7	77
11765-1	147	11848-4	127	12102L3	190	12794-1	150	14193-7	77
11766-1	147	11849-2	138	12110-1	190	12820-5	103	14194-7	77
11768-2	147	11851-2	138	12111L3	190	12822	103	14195-7	77
117680-7	120	11857-1	157	12112-1	190	12891	193	14196-7	77
117681-7	120	11861-6	144	12113L3	190	12891L3	193	14197-7	77
117684-7	121	11862-6	144	12114-1	190	12988-1	150	14215-6	142
11772-1	147	11865-4	133	12115L3	190	13055-4	136	1423-1	45
11775-5	149	11871-7	132	12120-1	190	13065-4	136	1423-5	45
11776-5	149	11873-1	105	12121-3	190	13066-7	136	14230-3	143
11778-2	150	11875-7	135	12124-1	190	1329-1	198	14233-7	143
11780-6	148	11880-1	157	12125-3	190	1341-1	45	14234-7	143
11783-7	150	11881-1	157	12126-1	190	1342-1	45	1425-1	45
11786B-1	137	11889D1	135	12127-3	190	1343-1	44	1425-5	45
11786B-7	137	11891D7	105	12303-3	193	1345-1	46	14253-3	144
11786W-1	137	11894-2	138	12305-3	193	1348-1	46	14255-3	144
11786W-7	137	11896-1	138	12355-3	193	1353-1	47	14258-6	142
11787-1	137	11897-2	138	12357-3	193	1364A1	47	14258B1	142
11788-1	137	11900-4	142	12412-1	193	1364A3	47	14258R1	142
11789-1	137	11901-4	142	12415	193	13700-7	114	14348-6	143
11789W	137	11909-7	148	12415L3	193	13702-4	114	14350-3	145
11789WD1	137	11926-7	150	12460-1	200	13753-7	114	14352-3	145
11792-6	124	11930-4	151	12461-3	200	14017	153	14361-5	146
11794-7	135	11944-7	148	12562-6	104	1405-1	47	14365-6	145
11807-2	132	11950-6	150	12701-5	130	1405-3	47	14366-6	145
11808-2	149	11951-6	150	12703D1	130	14060-7	152	14367-6	145
118091	135	11952-7	117	12704-1	130	14063-7	152	14370-6	146
118092-7	135	11953-4	151	12708-2	130	14064-7	152	14371-6	146
11820-7	104	11964-1	113	12750-6	131	14065-7	152	14372-7	146
11822	93	11966-1	113	12760-7	130	14066-7	153	1438	46
11822-6	92	11968-1	113	12761-7	131	14133-6	153	1438F1	46
11823	93	11969-4	113	12772-2	131	14137-7	138	1439F1	46

Part #	Page	Part #	Page	Part #	Page	Part #	Page	Part #	Page
14509-6	92	17209-1	32	22040A-4	76	238312-2	223	238915-1	223
14530-6	92	17211-3	32	22041A-1	76	238322-1	223	238916LSM1	225
14532-6	92	1733-1	43	22050A-4	75	238333-1	223	2445-7	137
14534	93	1733-4	43	22051A-4	75	238352-1	223	2449-1	137
14540	93	1749-1	43	22150A-4	75	238512-1	223	2449-7	137
14540-6	92	1749-4	43	22208A-5	76	238522-1	223	2520-1	60
14580-1	104	1751-1	43	22209-5	76	238522-4	223	2530-1	60
14582-1	104	17525	231	22240-R-5	76	2385400	225	2638-1	133
1476-1	129	17720	230	22250-HH-4	75	2385405	225	278ANZPM-1	220
1477-1	129	17721	230	22250-R-4	75	238608-1	223	278AO3AGL-1	220
1478-1	129	1872	230	22350-R-4	75	238609-1	223	278AO3AGS-1	220
1487A1	44	2012A	199	2244	228	238610-1	223	278AO3AM-1	220
1488-1	44	2012A1	199	2244-ADJ	228	238610-3	223	278AO3PGL-1	220
1488-5	44	2012A3	199	2244-ADJ-T	228	238610L1	224	278AO3PM-1	220
1493-1	44	202319	74	23050A	75	238611-1	223	278AOGY060-1	220
1493-5	44	202320	74	23051A	75	238611L1	224	278AOGY070-1	220
1494A	45	2027-1	200	23150A	75	238612-1	223	278AOGY080-1	220
1494A1	45	2027-7	200	23250-HH-4	75	238612-3	223	278AOGY090-1	220
1494A5	45	2028-1	200	23250-R-4	75	238613-1	223	278AOGY100-1	220
1494F	45	2050-1	201	23350-R-4	75	238613-3	223	278AOGY110-1	220
1494F1	45	2050-5	201	238027-1	223	238613L1	224	278AOGY120-1	220
1495-1	46	2053-1	201	238027-3	223	238614-1	223	278AOGY130-1	220
1495A1	46	2053-5	201	23809-7	222	238615-1	223	278AOP0912-BD-1	220
1495B	46	2054-1	201	23811-7	222	238615-3	223	278AOP1215-1	220
1495B1	46	2054-5	201	23813-7	222	238617-1	223	278AOP1519-1	220
1495B5	46	2061-1	201	238141-1	222	238625-1	223	278AOP1923-1	220
1499-1	44	2061-5	201	238142-1	222	238630-1	223	278AOZAGL-1	220
1499-5	44	2064	228	238142-7	222	238630L1	223	278AOZAGS-1	220
15221-7	161	2080-1	201	23815-7	222	238813LSM	225	278AOZAM-1	220
15232-7	161	2114	228	238150-1	222	238813LSM1	225	278AOZPGL-1	220
15700-3	230	2114-T	228	238151-1	222	238833LSM1	225	278AOZPM-1	220
1607-1	109	2134	228	238152-1	222	238908-1	223	30004-7	176
1607-3	109	2134-SS	228	238152-7	222	238909LSM1	225	30005-7	176
16205-2	105	2134-T	228	238153-1	222	238911-1	223	3004	228
16207-2	105	2134-T-SS	228	238153-7	222	238911L	225	3004-R	228
16208-7	105	2164	228	238162-1	222	238911L1	225	3004-R-T	228
1670-1	98	2164-T	228	238162-4	222	238912-1	223	3004-R-T-SS	228
1670-3	98	22011A-P-5	76	238164-1	222	238913-1	223	3004-T	228
1674-1	98	22012A-P-5	76	238300-1	223	238913L1	225	31000-5	176
1674-6	98	22014-P-1	76	238312-1	223	238913LSM1	225	32000-7	176

Part #	Page	Part #	Page	Part #	Page	Part #	Page	Part #	Page
32001-7	176	33107A-5	179	34022B-7	182	3845-1	30	3899-1	25
32002-7	176	33110A-5	179	34022S-7	182	3870-1	30	3899-3	25
32012B-7	182	33112A	178	34024B-7	182	3872-1	30	3900-1	25
32014B-7	182	33114A-5	179	34024S-7	182	3872-3	30	3909-1	25
32016B-7	182	33125-5	175	34026B-7	182	3872A1	30	400-B	160
32018B-7	182	33132A-5	179	34026S-7	182	3873-1	30	400-R	160
32020B-7	182	33137A-5	179	34112B-5	182	3873-3	30	4000-ADJ	160
32022B-7	182	33170A-5	179	34112S-5	182	3873A1	30	4000-ADJ-B	160
32024B-7	182	33184W-5	179	34114B-5	182	3874-1	30	4116-5	23
3204	228	33186W-5	179	34114S-5	182	3874-3	30	4118A	24
3204-R	228	33190-5	178	34116B-5	182	3874A1	30	4118A1	24
3204-R-T	228	33192-5	178	34116S-5	182	3875-1	30	4118A5	24
3204-R-T-SS	228	33192W-5	179	34118B-5	182	3875-3	30	4121-1	24
3204-T	228	33194-5	178	34118S-5	182	3875A1	30	4121-3	24
3204-T-SS	228	3325-3	191	34120B-5	182	3875B	30	4122-1	24
32112B-5	182	33505-1	183	34120S-5	182	3875B1	30	4122-3	24
32114B-5	182	33515-1	183	34122B-5	182	3875C1	32	4123-1	24
32116B-5	182	33517-1	183	34122S-5	182	3876-1	31	4125-1	24
32118B-5	182	33901-7	182	34124B-5	182	3876-3	31	4125-7	24
32120B-5	182	33919-7	182	34124S-5	182	3877-1	30	4131-1	22
32122B-5	182	3392-1	193	34126B-5	182	3877-3	30	4131-4	22
32124B-5	182	3392-3	193	34126S-5	182	3878-1	30	4133-1	22
33006A-7	179	3396-1	193	34210-1	175	3878-3	30	4140-4	22
33007A-7	179	3396-3	193	35040-1	176	3879-1	30	4141-1	21
33010A-7	179	34000-1	175	36110-1	174	3879-3	30	4141-4	21
33012A-7	179	34001-1	175	36111-1	174	3880-1	30	4142-1	21
33014A-7	179	34005-1	175	36161-1	174	3881-1	31	4143-1	21
33025-5	175	34010-1	175	36180-1	174	3881KIT-1	31	4143-4	21
33032A-7	179	34011-1	175	37100-1	174	3882-1	32	4144-1	21
33037A-7	179	34012B-7	182	37110-1	174	3885-1	31	4145-1	21
33070A-7	179	34012S-7	182	37111-1	174	3885-3	31	4199-7	23
33084W-5	179	34014B-7	182	37161-1	174	3886-1	31	4201-1	20
33086W-5	179	34014S-7	182	37180-1	174	3886-3	31	4201-7	20
33090-5	178	34015-1	175	37181-1	174	3888-1	32	4202-1	20
33090W	178	34016B-7	182	37200-1	174	3889-1	32	4202-7	20
33092-5	178	34016S-7	182	38000-1	175	3890-1	25	4232-1	31
33092W-5	179	34018B-7	182	38001-1	175	3890-3	25	4232-7	31
33094-5	178	34018S-7	182	38005-1	175	3892-1	25	424-ADJ	160
33101-5	176	34020B-7	182	38010-1	175	3896-1	30	436-ADJ	160
33106A-5	179	34020S-7	182	38011-1	175	3896-3	30	460-ADJ	160

Part #	Page	Part #	Page	Part #	Page	Part #	Page	Part #	Page
4730-1	14	5110-42-7	64	5530-54A7	62	5582-1	72	5650-4	18
4730-4	14	5110-48-7	64	5530-54BP1	62	5590-24-1	69	5651-1	18
4760-1	14	5110-54-7	64	5530-54BP7	62	5590-24-7	69	5653-1	18
4760-4	14	5253-4	23	5530-54T1	62	5590-30-1	69	5653-4	18
4770-1	14	5330-42-7	63	5530-54TB1	62	5590-30-7	69	5654-1	18
4770-4	14	5330-48-7	63	5530-60A7	62	5590-36-1	69	5654-4	18
4801-1	20	5340-54-7	64	5530-60BP1	62	5590-36-7	69	5660-1	18
4801-7	20	5350-PA12-7	71	5530-60T1	62	5590-42-1	69	5660-4	18
5009-4	125	5350-PA20-7	71	5530-66T1	62	5590-42-7	69	5661-1	18
5009W4	125	5358-P12-7	71	5540-54A7	63	5606-1	16	5663-1	18
5010-4	125	5505-1	12	5540-54T1	63	5606-7	16	5663-4	18
5011-7	126	5505-2	12	5540-60T1	63	5606B-1	16	5664-1	18
5012-7	126	5505-7	12	5540-72T1	63	5608-1	16	5664-4	18
5014-4	125	5508-1	12	5540-72TB1	63	5608-7	16	5940-7	72
5016-3	126	5508-2	12	5540-84T1	63	5608B-1	16	6001-7	69
5022-7	126	5508-7	12	5550-12Z1	70	5609-1	16	6100-AT-1	69
5030-4	126	5509-1	12	5550-24Z1	70	5609-7	16	6100-AT-7	69
5031	127	5509-2	12	5550-30Z1	70	5609B-1	16	6100-LT-1	69
5031D1	127	5509-7	12	5550-36Z1	70	5610-48-7	64	6100-LT-7	69
5040G	56	5512-1	12	5550-P12-1	70	5612-1	16	6115-1	24
5040G7	56	5512-2	12	5550-P20-1	70	5612-7	16	6244-1	190
5040R	56	5512-7	12	5550-P24-1	70	5612B-1	16	6244-6	190
5040R7	56	5513-1	12	5550-PA20-7	70	5613-1	16	6245-1	190
5045-7	56	5513-2	12	5550-S12-1	70	5613-7	16	6245-6	190
5060-3	128	5513-7	12	5550-S18-1	70	5613B-1	16	6260-4	154
5061-3	128	5530-12T1	62	5550-S24-1	70	5614-7	23	6317-1	82
5062-3	128	5530-24A7	62	5550-S30-1	70	5620-6	16	6319-1	82
5063-3	128	5530-24BP1	62	5550-S36-1	70	5620-6	18	6320B	81
5071-3	128	5530-24BP7	62	5550-S42-1	70	5622-6	16	6320W	81
5072-7	128	5530-30BP1	62	5551-P12-1	70	5622-6	18	6320W1	81
5074-3	128	5530-36A7	62	5551-PA20-7	70	5624-6	16	6320W7	81
5080G	56	5530-36BP1	62	5557-P12A7	70	5624-6	18	6321B1	81
5080G7	56	5530-36BP7	62	5557-PV12A7	70	5640-1	18	6323W1	81
5080R	56	5530-42A7	62	5558-P12A7	70	5640-4	18	6323W7	81
5080R7	56	5530-42BP1	62	5570-60-1	63	5641-1	18	6340SS	81
5091-14-7	59	5530-42BP7	62	5570-72-1	63	5643-1	18	6341SS	81
5092-14-7	59	5530-42T1	62	5580-03	72	5643-4	18	6342	81
5110-24-7	64	5530-48A7	62	5580-1	72	5644-1	18	6342SS1	81
5110-30-7	64	5530-48BP1	62	5580A7	72	5644-4	18	6342SS7	81
5110-36-7	64	5530-48T1	62	5581-1	72	5650-1	18	6343	81

Part #	Page	Part #	Page	Part #	Page	Part #	Page	Part #	Page
63439	229	65UW03G-1	80	66061-3	108	66362-7	129	66516-1	187
6343SS7	81	65UW03G-7	80	66062-1	188	66362W1	129	66516-7	187
6344SS1	81	65UW03W	80	66063-1	188	66362W7	129	66517-1	186
6346SS1	81	65UW03W-1	80	66064-1	188	66363-1	129	66517-7	186
6348SS1	81	65UW03W-7	80	66074-3	108	66363-7	129	66519-1	186
6350	82	65UW06B-1	80	66104-1	196	66363W1	129	66522-1	187
6350B1	82	65UW06B-7	80	66105	196	66363W7	129	66524-1	187
6350B7	82	65UW06CVSS-1	80	66105-1	150	66364-1	129	66529-1	186
6350W1	82	65UW06G-1	80	66105-1	196	66364-7	129	66531-1	186
6350W7	82	65UW06G-7	80	66110-1	189	66364W1	129	66533-1	186
6351	82	65UW06W-1	80	66110-3	189	66364W7	129	66538-1	186
6351B1	82	65UW06W-7	80	66111-1	189	66398-1	189	66540-1	26
6351G1	82	65UW12B-1	80	66111-3	189	66399-1	47	66540-3	26
6351W1	82	65UW12B-7	80	66112-1	189	66399-3	47	66540G	26
6353W7	82	65UW12CVSS-1	80	66120-1	191	66400-1	47	66541-1	26
6354W7	82	65UW12W-7	80	66123-T	229	66400-3	47	66541-3	26
6355W7	82	66004-1	109	66126C1	108	66406-5	108	66542-1	26
6375D6	57	66008-1	192	66163-1	198	66408C1	108	66542-3	26
6443-T-P-SS	229	66009-1	189	66202-3	196	66411	108	66543-1	26
64439-SS	229	66009L6	189	66223-1	192	66411C1	108	66543-3	26
6450-1	130	66010-1	189	66223-3	192	66412C1	108	66544-1	26
6451-1	130	66010L3	189	66224-1	192	66419-1	98	66544-3	26
6483	229	66011-1	189	66239-1	197	66419-3	98	66545-1	26
6483-T	229	66011-3	189	66239-3	197	66423-1	199	66545-3	26
64839	229	66012-1	189	66240-1	197	66434-1	197	66546-1	26
6521SS	78	66023-1	109	66261-1	193	66446C	108	66546-3	26
6521SS1	78	66025-1	197	66261L3	193	66446C1	108	66546G	26
6522SS	78	66027-1	198	66262-1	193	66448-1	194	66547-1	26
6522SS1	78	66027-3	198	66263-1	193	66449-1	194	66547-3	26
6522SS7	78	66028-1	198	66308-1	32	66470-1	129	66548-1	26
6523BK	78	66029-1	198	66308-3	32	66470-7	129	66548-3	26
6523BK1	78	66029-3	198	66318-7	57	66471-1	129	66549-1	26
6523BK7	78	66031-1	109	66319G	57	66502-1	189	66549-3	26
6556-1	72	66031-3	109	66319G7	57	66510-1	187	66550-1	26
6556-7	72	66032-1	109	66319R	57	66510-7	187	66550-3	26
65UW03B	80	66032-3	109	66319R7	57	66512-1	187	66551-1	26
65UW03B-1	80	66054-1	188	66334-1	188	66514-1	187	66551-3	26
65UW03B-7	80	66055-1	188	66335-1	188	66514-7	187	66552-1	26
65UW03CVSS-1	80	66056-1	188	66336-1	188	66515-1	186	66553-1	27
65UW03G	80	66060-1	108	66362-1	129	66515-7	186	66553-3	27

Part #	Page	Part #	Page	Part #	Page	Part #	Page	Part #	Page
66553KIT	27	67556-1	28	7062-3	231	7533PD2	33	7800-42-7	69
66555-1	27	67557-1	28	7100	65	7534A1	33	7812	73
66555KIT	27	67558-1	28	7100A7	65	7534A3	33	7812-S-1	73
66557-1	27	67561-1	28	7100B7	65	7555-1	32	7812-S-7	73
66557G	27	67562-1	28	7100C7	65	7555-3	32	7812Z1	73
66558G	27	67580-1	28	71011-1	172	7557-1	32	7824-S-1	73
66559-1	27	67581-1	28	71012-1	172	7557-7	32	7836-S-1	73
66561-1	27	67582-1	28	71081-1	172	7557G1	32	7842-S-1	73
66563-1	27	67583-1	28	71082-1	172	7563-1	144	8043-3	133
66565-1	27	67729	229	71182-1	172	7563-6	144	815000	231
66567-1	27	67729-T	229	7153-T-SS	228	7566AR1	33	818440	224
66577-1	27	6773	229	7201-P-7	73	7566BG	33	818441	224
66579-1	27	6773-T	229	7202-P-7	73	7566BG1	33	818441-3	224
66586-1	187	6773-T-U	229	729493-5	76	7571-1	83	828461	224
66588-1	187	67739	229	729494-5	76	7571L7	83	83011-1	173
66589-1	187	67739-SC	229	729823-P-5	76	7591-6	144	83012-1	173
66617-1	186	67739-SC	229	729829-P-5	76	7594-1	144	83081-1	173
6682	229	67739-SS	229	7518A3	33	7594-3	144	83082-1	173
6682-T	229	67739-SS	229	7518PD2	33	76030-6	183	83111-1	173
6683-T	229	67749	229	7520A1	33	76080-3	177	83112-1	173
66832-1	199	68551-1	29	7520A3	33	76090-3	177	8315-4	133
66839	229	68554-1	29	7520PD2	33	76130-6	183	83181-1	173
66970-7	130	68555-1	29	7524	33	7615-3	24	83182-1	173
66HR09	201	68556-1	29	7524A1	33	7615A-3	24	8803LP	87
66HR09-1	201	68557-1	29	7524A7	33	76180-6	177	8803LP2	87
66HRD12	201	68576-1	29	7524B1	33	76190-6	177	8803LP2S	87
66HRD12-1	201	68577-1	29	7524D1	33	7621-7	153	8803LPG	87
66UW03B-7	80	68578-1	29	7524PD2	33	7622-7	145	8803LPG2	87
66UW06B-1	80	68579-1	29	7526	33	7623-7	146	8803LPG2S	87
66UW06B-7	80	68581-1	29	7526A1	33	7640-3	193	8806LP	87
66UW06G-1	80	7006-1	217	7526A7	33	7647-7	145	8806LP2	87
66UW06W-1	80	7009-1	217	7526D1	33	7648-7	145	8806LP2S	87
66UW12B-1	80	7023	215	7526D2	33	7651-3	193	8806LPG	87
66UW12B-7	80	7033	215	7526PD1	33	7653L3	193	8806LPG2	87
66UW12W-7	80	7040-1	215	7526PD2	33	7663-5	153	8806LPG2S	87
67551-1	28	7041	215	7532A3	33	7800-24-1	69	8812LLP2	87
67552-1	28	7043	215	7533	33	7800-24-7	69	8812LLPG	87
67553-1	28	7044	215	7533A1	33	7800-36-1	69	8812LLPG2	87
67554-1	28	7060-1	215	7533A7	33	7800-36-7	69	8812LP	87
67555-1	28	7062	231	7533PD2	33	7800-42-1	69	8812LP2	87

Part #	Page	Part #	Page	Part #	Page	Part #	Page	Part #	Page
8812LPG	87	8M0044687	89	9098-5	141	911490-1	67	9356D1	115
8812LPG2	87	9006-1	141	9099-1	141	911507-1	98	9358-1	115
8838HF6	90	9013-1	141	9099-5	141	911508-1	98	9358B1	115
8838HM6	90	9013-3	141	91022-1	67	911526-1	98	9372-2	105
8838TM6	90	9013A3	141	91022-7	67	911528-1	98	93806AUS7	91
8838US6	90	9014-1	141	910R2PB	66	91320	230	93806EI7	106
8838US6	93	9014-3	141	910R2PB-1	66	91320-ADJ	230	93806ELP7	91
8873-6	92	9014A1	141	910R2PB-7	66	913670	70	93806EUS7	91
8882-6	92	9014A3	141	910R2PSB	66	913670-1	70	93806EUSD7	91
8883-6	92	9015-1	139	910R2PSB-1	66	913671-1	70	93806HUS7	91
8884-6	92	9015-3	139	910R2PSB-7	66	914108	214	93806MI7	106
8887-6	92	9016-1	139	910R2PSW-1	66	914113	214	93806MUS7	91
8889LP	93	9016-3	139	910R3PB-1	66	9146-3	193	93806MUSD7	91
8889LP6	92	903-008-T-S	195	910R3PB-7	66	9146-6	149	93806UFDV7	91
8890LP	93	903-009-S	195	910R3PSB-1	66	9149-6	149	93806UI7	106
8890LP6	92	9065-1	140	910R3PSB-7	66	9185J1	25	93806ULP7	91
8896LP	93	9067-1	140	910T2PB-1	66	922-ADJ-S	195	93806UUS7	91
8896LP6	92	9069-1	140	910T2PB-7	66	923-009	195	93806UUSD7	91
8897-6	92	9070-1	139	910T2PSB-1	66	923-009-ADJ	195	93806YI7	106
88FAS014	93	9070-7	139	910T2PSB-7	66	9300FDV	89	93806YLP7	91
88FAS014-6	92	90720	230	910T2PSW-1	66	9300FDV7	89	93806YUS7	91
88FAS038	93	9076-1	140	910T3PB-1	66	93014LP7	88	93812ULP7	91
88FAS038-6	92	9082-1	140	910T3PB-7	66	93038I7	106	93812UUS7	91
88FBM101	93	9083-7	136	910T3PSB-1	66	93038LP7	88	93812UUSD7	91
88FBM101-6	92	9084-1	140	910T3PSB-7	66	9350-4	114	9400-7	134
88FBMA102	93	9090-1	141	910T3PSW-1	66	9351-2	114	9401-7	134
88FBMA102-6	92	9090-5	141	910V2PB-1	65	93516I7	106	94100-4	146
88FHE516	93	9091-1	141	910V2PB-7	65	93516LP	88	94110-5	146
88FHE516-6	92	9091-5	141	910V2SS-1	65	93516LP7	88	9433-S	195
88FHY516	93	9092-5	141	910V2SS-7	65	93531-1	116	9436-S	195
88FHY516-6	92	9093-5	141	910V3PB-1	65	93532-1	116	951606ULP7	91
88FTS014	93	9094-1	141	910V3PB-7	65	93533-1	116	952	195
88FTS014-6	92	9094-5	141	910V3SS-1	65	93534-1	116	96008	195
88FV200	92	9095-1	141	910V3SS-7	65	93536-1	115	9709-7	127
88FV200-6	92	9095-5	141	911339-1	67	93537-1	116	97100-001-1	213
88TC06	104	9096-1	141	911339-7	67	9354BD1	115	97100-001-2	213
88TC06-7	104	9096-5	141	911370-1	66	9354D1	115	97100-005-1	213
8900-6	92	9097-1	141	911370	66	9355BD1	115	97100-005-2	213
8901-6	92	9097-5	141	911445	66	9355D1	115	97100-006-1	213
8902-6	92	9098-1	141	911490	67	9356BD1	115	97100-006-2	213

Part #	Page	Part #	Page	Part #	Page	Part #	Page	Part #	Page
977339-T	227	99201WS1	107	99CC045H1	99	99DVB01-1	100	AK5605S-7	18
97739	227	99201WZ1	107	99CC045HSA1	99	99DVB02-1	100	AK5612-7	16
97739-T	227	99202AWS1	107	99CC045V1	99	99DVC01-1	100	AK5612S-7	18
97749-7	227	99202AWSY1-1	107	99CC085-1	99	99DVP03-1	100	AK5670-7	18
97749C-7	227	99202WS1	107	99CC085-1S	99	99DVP04-1	100	AS5505E-1	12
97750-7	227	99202WZ1	107	99CC085H1	99	99DVP05-1	100	AS5505S-1	12
97750C-7	227	99210GB	107	99CC085HSA1	99	99FLA140-1	102	AS5512E-1	12
98100-1	217	99210GB1	107	99CC085HSA1S	99	99FLA170-1	102	AS5512S-1	12
98120-1	217	99211GB1	107	99CC150-1	99	99FLA230-1	102	AS5605E-1	16
98124	217	9933-1	112	99CC150-1S	99	99FLA330-1	102	AS5605ES-1	18
98201-1	215	9933B1	112	99DFCCAB1	97	99FLB080-1	102	AS5605QLE-1	18
98202-1	215	9934-1	112	99DFCCAB1S	97	99FLB080-1S	102	AS5605QLS-1	18
98203-1	215	9934B1	112	99DFCCAS1	97	99FLB100-1	102	AS5605S-1	16
98204-1	215	9935-1	112	99DFCCAS1S	97	99FLB100-1S	102	AS5605SS-1	18
98390GY	213	9935B	112	99DFCCASY1-1	97	99FLB140-1	102	AS5612E-1	16
9842-1	32	9935B1	112	99DFCCAW1	97	99FLB140-1S	102	AS5612ES-1	18
9842-3	32	9941-1	112	99DFCCA1	97	99FLB170-1	102	AS5612S-1	16
9842PD1	32	9941B1	112	99DFCCA1S	97	99FLB170-1S	102	AS5612SS-1	18
9844PD2	32	9942-1	112	99DFCCCLPAS1	97	99FLB230-1	102	ATT001	218
98505CA	213	9942B1	112	99DFCCCLPSS1	97	99FLB230-1S	102	ATT002	218
98505GY	213	9943-1	112	99DFCCSB1	97	99FLB330-1	102	ATT007	218
98505WH	213	9943B	112	99DFCCSS1	97	99FLB330-1S	102	ATT008	218
98900-1	216	9943B1	112	99DFCCSS1S	97	99GVG000-1	102	ATT009	218
98908-1	216	9945B1	112	99DFCCSSY1-1	97	99GVN900-1	102	ATT016	218
98910-1	216	9946-1	112	99DFCCSW1	97	99GVP000-1	102	ATT101	215
98961-1	214	9946B1	112	99DFCCSZ1	97	99GVPKT-1	102	ATT103	215
98963-1	214	9948-1	112	99DFCCSZ1S	97	99ICV000-1	102	ATT109	215
98990-1	214	9948B	112	99DFPVAB1	100	99ICV000HS2	102	ATT110	215
98991-1	214	9948B1	112	99DFPVAB1S	100	99IFDV00-1	100	ATT119	214
99200DS1	107	9955-1	113	99DFPVAS1	100	99IFDVHS1	100	ATT120	214
99200GB1	107	9956-1	113	99DFPVAS1S	100	99IFDVKT-1	100	ATT200-1	216
99200GS	107	9957-1	113	99DFPVASY1-1	100	99TDF100-1	98	ATT205-1	216
99200GS1	107	9960-1	113	99DFPVAZ1	100	99TDFPV100-1	101	ATT210-1	216
99200GZ1	107	9961-1	113	99DFPVSB1	100	99TDFPV110-1	101	N10863-4	40
99200WS1	107	9962-1	113	99DFPVSB1S	100	99USCGTESTER	103	N10863DW-5	41
99200WZ1	107	9963-1	113	99DFPVSS1	100	99USCGTESTERCC	103	N10864-4	40
99201DS1	107	99CC	99	99DFPVSS1S	100	99USCGTESTERPRV	103	N10864DW-5	41
99201GB1	107	99CC035-1	99	99DFPVSSY1-1	100	AK5505-7	12	N10866-5	41
99201GS1	107	99CC045-1	99	99DFPVSZ1	100	AK5512-7	12	N10867-5	41
99201GZ1	107	99CC045-1S	99	99DVA02-1	100	AK5605-7	16	N10869-5	41

Part #	Page	Part #	Page	Part #	Page	Part #	Page	Part #	Page
N10870-5	41	NV4012SS	55	NV6SP1-20-1	58	SL32-30-5	203	SL44BP3R-1	205
N10873-5	41	NV4012SS-1	55	NV6SP2-10-1	58	SL32-XX-1	202	SL44P3-1	205
N10874-5	41	NV4012SSG-7	55	NV6SP2-14-1	58	SL33-20-5	203	SL44P3R-1	205
N10963-4	40	NV4012SSR-7	55	RH-4646	125	SL33-30-5	203	SL44SSP3-1	205
N10964-4	40	NV5012PB-1	55	SL1-20-5	203	SL33-40-5	203	SL46SSP3-1	205
N20020-4	39	NV5012SS-1	55	SL1-40-5	203	SL33-50-5	203	SL46SSP3R-1	205
N20030-4	39	NV6LC1	58	SL1-XX-1	202	SL33-60-5	203	SL48BP3R-1	205
N20790-5	38	NV6LC1-10-1	58	SL10-40-5	203	SL33-XX-1	202	SL48P3-1	205
N20803CAP-5	38	NV6LC1-10A7	58	SL10-XX-1	202	SL34-120-5	203	SL48P3R-1	205
N20803S-4	38	NV6LC1-10B1	58	SL11-XX-1	202	SL34-20-5	203	SL48SSP3-1	205
N20803W-4	38	NV6LC1-10BP1	58	SL13-20-5	203	SL34-30-5	203	SL50BP3-1	205
N20804CAP-5	38	NV6LC1-12-1	58	SL13-60-5	203	SL34-40-5	203	SL50P3-1	205
N20804S-4	38	NV6LC1-12BP1	58	SL13-XX-1	202	SL34-50-5	203	SL50P3R-1	205
N20804W-4	38	NV6LC1-14-1	58	SL14-20-5	203	SL34-60-5	203	SL50SSP3-1	205
N20890-4	38	NV6LC1-14-7	58	SL14-30-5	203	SL34-80-5	203	SL50SSP3-7	204
N28810-5	39	NV6LC1-14A7	58	SL14-40-5	203	SL34-90-5	203	SL50SSP3R-1	205
NV0002P-1	55	NV6LC1-14BP1	58	SL14-60-5	203	SL34-XX-1	202	SL50SSP3SB-1	205
NV0002S-1	55	NV6LC1-14BP7	58	SL14-XX-1	202	SL35-20-5	203	SL513HBP3R-1	206
NV1002PB	54	NV6LC1-16-1	58	SL15-XX-1	202	SL35-30-5	203	SL513HP3R-1	206
NV1002PB-1	54	NV6LC1-16BP1	58	SL16-30-5	203	SL35-40-5	203	SL514HSSP3-1	206
NV1002SS	54	NV6LC1-20-1	58	SL16-XX-1	202	SL35-50-5	203	SL52P3-1	206
NV1002SS-1	54	NV6LC2	58	SL2-40-5	203	SL35-XX-1	202	SL52P3R-1	206
NV1012PB-1	54	NV6LC2-10-1	58	SL2-XX-1	202	SL36-20-5	203	SL52SSP3-1	206
NV1012SS	54	NV6LC2-10-7	58	SL20-XX-1	202	SL36-30-5	203	SL52SSP3R-1	206
NV1012SS-1	54	NV6LC2-14-1	58	SL25-XX-1	202	SL36-40-5	203	SL54SSP3-1	206
NV2002PB-1	54	NV6LC2-14-7	58	SL26-XX-1	202	SL36-50-5	203	SL57P3-1	206
NV2002PB-7	54	NV6LC2-14BP1	58	SL27-XX-1	202	SL36-60-5	203	SL57SSP3R-1	206
NV2002SS-1	54	NV6LC2-14BP7	58	SL28-XX-1	202	SL36-70-5	203	SL58BP3-1	206
NV2002SS-7	54	NV6SP1-10-1	58	SL29-XX-1	202	SL36-80-5	203	SL58BP3R-1	206
NV2012PB	54	NV6SP1-10-1	60	SL3-60-5	203	SL36-90-5	203	SL58P3-1	206
NV2012PB-1	54	NV6SP1-12-1	58	SL3-XX-1	202	SL36-XX-1	202	SL58P3R-1	206
NV2012PBG-7	54	NV6SP1-12-1	60	SL30-20-5	203	SL37-XX-1	202	SL58SSBP3R-1	206
NV2012PBR-7	54	NV6SP1-12A1	58	SL30-40-5	203	SL38-XX-1	202	SL58SSP3-1	206
NV2012SS-1	54	NV6SP1-12BP1	58	SL30-60-5	203	SL3HSSP3-1	205	SL58SSP3R-1	206
NV2012SSR-7	54	NV6SP1-14-1	58	SL30-XX-1	202	SL4-XX-1	202	SL61SSBS-1	207
NV2012SSG-7	54	NV6SP1-14-1	60	SL31-20-5	203	SL40BP3-1	205	SL62SSBS-1	207
NV3012SS	55	NV6SP1-14A1	58	SL31-30-5	203	SL40P3-1	205	SL63SSBS-1	207
NV3012SS-1	55	NV6SP1-16-1	58	SL31-40-5	203	SL40SSBP3-1	205	SL64-BS-1	204
NV3012SSG-7	55	NV6SP1-16-1	60	SL31-XX-1	202	SL40SSP3-1	205	SL64SSBS-1	204
NV3012SSR-7	55	NV6SP1-19A1	58	SL32-20-5	203	SL40SSP3-7	204	SL65BP3-1	207

Part #	Page	Part #	Page	Part #	Page	Part #	Page
SL65P3-1	207	SP-400-RB	160	ST14-60-5	203	ST36-50-5	203
SL65SSP3-1	207	SP-4000-ADJ-RB	160	ST14-XX-1	202	ST36-60-5	203
SL69-BS-1	204	SP-402	160	ST15-XX-1	202	ST36-70-5	203
SL69SSBS-1	204	SP-410	160	ST20-XX-1	202	ST36-90-5	203
SL70-BS-1	204	SP-416	160	ST26-XX-1	202	ST36-XX-1	202
SL70BS	204	SP-421-RB	160	ST29-XX-1	202	ST37-XX-1	202
SL72SSBS-1	207	SP-424-ADJ-RB	160	ST30-20-5	203	STX20-XX-1	202
SL74SSBS	204	SP-429-RB	160	ST30-40-5	203	STX29-XX-1	202
SL74SSBS-1	204	SP-436-ADJ-RB	160	ST30-60-5	203		
SL75-SSBS-1	204	SP-64839	229	ST30-XX-1	202		
SL76SSP3-1	207	SP-66839	229	ST31-20-5	203		
SL76SSP3R-1	207	SP-67739	229	ST31-30-5	203		
SL77P3-1	207	SP-67739-T	229	ST31-40-5	203		
SP-1002	227	SP-67749	229	ST31-XX-1	202		
SP-14000	231	SP-68914	226	ST32-20-5	203		
SP-15100	230	SP-7153-T-SS	228	ST32-30-5	203		
SP-15200	230	SP-910	195	ST32-XX-1	202		
SP-15900	230	SP-923-009-ADJ	195	ST33-20-5	203		
SP-18914	226	SP-96008	195	ST33-30-5	203		
SP-2114	228	SP-96009	195	ST33-40-5	203		
SP-2114-T	228	SPL-12B-4	74	ST33-50-5	203		
SP-2134	228	SPL-12B.OEM-1	74	ST33-60-5	203		
SP-2134-T	228	SPL-12C-4	74	ST33-XX-1	202		
SP-2164	228	SPL-12C.OEM-1	74	ST34-120-5	203		
SP-2164-T	228	SPL-12W-4	74	ST34-20-5	203		
SP-2244	228	SPL-12W.OEM-1	74	ST34-30-5	203		
SP-2244-ADJ	228	SPL-24B.OEM-1	74	ST34-40-5	203		
SP-2244-ADJ-T	228	SPL-24W.OEM-1	74	ST34-50-5	203		
SP-28911	226	SPLR-1-4	74	ST34-60-5	203		
SP-28913	226	SPLR-2-4	74	ST34-80-5	203		
SP-3004	228	SPLR-3-4	74	ST34-90-5	203		
SP-3004-R	228	ST10-40-5	203	ST34-XX-1	202		
SP-3004-R-T	228	ST10-XX-1	202	ST35-20-5	203		
SP-3004-T	228	ST11-XX-1	202	ST35-30-5	203		
SP-3204	228	ST13-60-5	203	ST35-40-5	203		
SP-3204-R	228	ST13-XX-1	202	ST35-50-5	203		
SP-3204-R-T	228	ST14-20-5	203	ST35-XX-1	202		
SP-3204-T	228	ST14-30-5	203	ST36-20-5	203		
SP-37904	226	ST14-40-5	203	ST36-30-5	203		
SP-37914	226	ST14-50-5	203	ST36-40-5	203		

Ingress Protection (IP) Ratings Guide









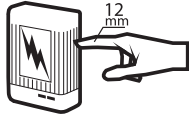

Example:

An IP65 rating can be determined using the adjacent table and example:

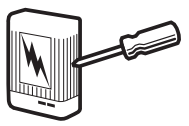
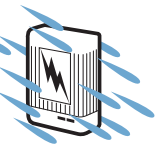
- The first number of the rating example, 6, in the gray column means the enclosure is dust tight
- The second number of the rating example, 5, in the blue column means the enclosure is protected against jets of water

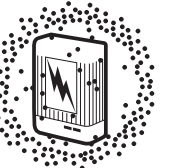
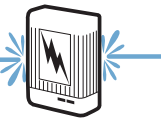
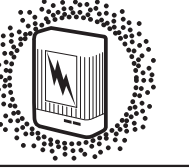
The IP rating system was established by the International Electrotechnical Commission (IEC), an organization for international standards and conformity assessment. The IEC collaborates closely with the International Organization for Standardization (ISO). A complete description of the IP ratings and associated tests is found in IEC Publication 529. Although these ratings were initially developed as a way to classify enclosures, they now provide a convenient, practical way to compare levels of sealing. Many electrical products have an Ingress Protection (IP) rating which identifies the environmental factors needing consideration prior to the product's installation.

This is important when deciding when to mount products in a dry and clean environment versus a wet and/or dusty environment. The IP rating indicates the degree of protection provided. The numbers following IP represent levels of sealing and can range from no protection to full protection against dust and water. The table provides a description of the protection at each level.

SOLIDS		WATER	
1	 Protected against a solid object greater than 50 mm such as a hand.	1	 Protected against vertically falling drops of water. Limited ingress permitted.
2	 Protected against a solid object greater than 12 mm such as a finger.	2	 Protected against vertically falling drops of water with enclosure tilted up to 15 degrees from the vertical. Limited ingress permitted.
3	 Protected against a solid object greater than 2.5 mm such as a screwdriver.	3	 Protected against sprays of water up to 60 degrees from the vertical. Limited ingress permitted for three minutes.
4	 Protected against a solid object greater than 1 mm such as a wire.	4	 Protected against water splashed from all directions. Limited ingress permitted.
5	 Dust Protected. Limited ingress of dust permitted. Will not interfere with operation of the equipment. Two to eight hours.	5	 Protected against jets of water. Limited ingress permitted.
6	 Dust tight. No Ingress of dust. Two to eight hours.	6	 Water from heavy seas or water projected in powerful jets shall not enter the enclosure in harmful quantities.
		7	 Protection against the effects of immersion in water between 15 cm and 1 m for 30 minutes.
		8	 Protection against the effects of immersion in water under pressure for long periods.

Rating Example:

IP65

INGRESS PROTECTION

NAVICO GROUP

Attwood Corporation
1016 North Monroe Street
Lowell, MI 49331
p 616.897.9241
attwoodmarine.com

©2024 Attwood Corporation
All rights reserved

Unauthorized copying or
reproduction is a violation
of applicable laws.

ATT-003-CAT-0724

